



## LANDMARK CARS LIMITED

CORPORATE IDENTITY NUMBER: U50100GJ2006PLC058553

REGISTERED OFFICE	CORPORATE OFFICE	CONTACT PERSON
Landmark House, Opp. AEC, S.G. Highway, Thaltej, Near Gurudwara, Ahmedabad 380 059, Gujarat, India Telephone: +91 79 6618 5555	Unit No. 201 to 203, Landmark, 2nd Floor, G. M. Bhosale Marg, Worli, Mumbai 400 018, Maharashtra, India	Amol Arvind Raje Company Secretary and Compliance Officer
EMAIL	TELEPHONE	WEBSITE
companysecretary@landmarkindia.net	+91 22 6271 9040	www.grouplandmark.in

### THE PROMOTER OF OUR COMPANY IS SANJAY KARSANDAS THAKKER

Initial public offering of up to [•] Equity Shares of face value ₹ 5 each (“**Equity Shares**”) aggregating up to ₹ 7,620.00 million (“**Offer**”) which comprises:

- Fresh issue of up to [•] Equity Shares aggregating up to ₹ 1,500 million (“**Fresh Issue**”).
- Offer for Sale up to [•] Equity Shares aggregating up to ₹ 6,120 million (“**Offer for Sale**”).

This Offer is being made through the Book Building Process, in terms of Rule 19(2)(b) of the Securities Contracts (Regulation) Rules, 1957, as amended (“**SCRR**”) read with Regulation 31 of the Securities and Exchange Board of India (Issue of Capital and Disclosure Requirements) Regulations, 2018, as amended (the “**SEBI ICDR Regulations**”) and in compliance with Regulation 6(1) of the SEBI ICDR Regulations.

OFFER FOR SALE			
NAME OF SELLING SHAREHOLDER	TYPE	NUMBER OF SHARED OFFERED/ AMOUNT (₹ IN MILLION)	AVERAGE COST OF ACQUISITION (IN ₹)
TPG GROWTH II SF PTE. LTD.	other	4,000.00	137.42
SANJAY KARSANDAS THAKKER HUF	Promoter Group	620.00	3.30
AASTHA LIMITED	other	1,200.00	9.36
GARIMA MISRA	other	300.00	3.30
BID/OFFER PROGRAMME			
ANCHOR INVESTOR BIDDING DATE			[•]*
BID/OFFER OPENS ON			[•]
BID/OFFER CLOSES ON			[•]**

\*Our Company and the Selling Shareholders in consultation with the BRLMs may consider participation by Anchor Investors in accordance with the SEBI ICDR Regulations. The Anchor Investor Bidding Date shall be one Working Day prior to the Bid/Offer Opening Date.

\*\*Our Company and the Selling Shareholders in consultation with the BRLMs may consider closing the Bid/Offer Period for QIBs one Working Day prior to the Bid/Offer Closing Date in accordance with the SEBI ICDR Regulations.



## LANDMARK CARS LIMITED

Our Company was originally incorporated as "Landmark Insurance Broking Private Limited" at Mumbai as a private limited company under the Companies Act, 1956, pursuant to a certificate of incorporation dated February 23, 2006, issued by the Registrar of Companies, Maharashtra at Mumbai ("RoC, Mumbai"). The name of our Company was subsequently changed to "Landmark Cars Private Limited" pursuant to a fresh certificate of incorporation granted by the RoC, Mumbai on May 6, 2009. Subsequently, our Company was converted into a public limited company under the Companies Act, 2013, pursuant to the approval accorded by our Shareholders at their extra-ordinary general meeting held on November 10, 2021. Consequently, the name of our Company was changed to "Landmark Cars Limited" and a fresh certificate of incorporation consequent upon conversion from a private limited company to a public limited company was issued to our Company by the Registrar of Companies, Gujarat, Dadra & Nagar Haveli at Ahmedabad ("RoC") on December 3, 2021. For further details relating to the changes in the name of our Company and the registered office of our Company, see "History and Certain Corporate Matters" on page 166.

**Corporate Identity Number:** U50100GJ2006PLC058553; **Website:** www.grouplandmark.in

**Registered Office:** Landmark House, Opp. AEC, S.G. Highway, Thaltej, Near Gurudwara, Ahmedabad 380 059, Gujarat, India; **Telephone:** +91 79 6618 5555;

**Corporate Office:** Unit No. 201 to 203, Landmark, 2nd Floor, G. M. Bhosale Marg, Worli, Mumbai 400 018, Maharashtra, India

**Contact Person:** Amol Arvind Raje, Company Secretary and Compliance Officer; **Telephone:** +91 22 6271 9040; **E-mail:** companysecretary@landmarkindia.net

### THE PROMOTER OF OUR COMPANY IS SANJAY KARSANDAS THAKKER

INITIAL PUBLIC OFFERING OF UP TO [●] EQUITY SHARES OF FACE VALUE OF ₹5 EACH ("EQUITY SHARES") OF OUR COMPANY FOR CASH AT A PRICE OF ₹[●] PER EQUITY SHARE (INCLUDING A SHARE PREMIUM OF ₹ [●] PER EQUITY SHARE) ("OFFER PRICE") AGGREGATING UP TO ₹ 7,620.00 MILLION ("OFFER"). THE OFFER COMPRISES A FRESH ISSUE OF UP TO [●] EQUITY SHARES AGGREGATING UP TO ₹ 1,500.00 MILLION ("FRESH ISSUE") AND AN OFFER FOR SALE OF UP TO [●] EQUITY SHARES ("OFFERED SHARES") AGGREGATING UP TO ₹ 6,120.00 MILLION, COMPRISING OF UP TO [●] EQUITY SHARES AGGREGATING UP TO ₹ 4,000.00 MILLION BY TPG GROWTH II SF PTE. LTD., UP TO [●] EQUITY SHARES AGGREGATING UP TO ₹ 620.00 MILLION BY SANJAY KARSANDAS THAKKER HUF, UP TO [●] EQUITY SHARES AGGREGATING UP TO ₹ 1,200.00 MILLION BY AASTHA LIMITED AND UP TO [●] EQUITY SHARES AGGREGATING UP TO ₹ 300.00 MILLION BY GARIMA MISRA (TPG GROWTH II SF PTE. LTD., SANJAY KARSANDAS THAKKER HUF, AASTHA LIMITED AND GARIMA MISRA ARE COLLECTIVELY REFERRED TO AS THE "SELLING SHAREHOLDERS", AND EACH INDIVIDUALLY, AS A "SELLING SHAREHOLDER" AND SUCH OFFER FOR SALE OF EQUITY SHARES BY THE SELLING SHAREHOLDERS, THE "OFFER FOR SALE").

THIS OFFER INCLUDES A RESERVATION OF UP TO [●] EQUITY SHARES AGGREGATING UP TO ₹ [●] MILLION (CONSTITUTING UP TO [●]% OF THE POST-OFFER PAID-UP EQUITY SHARE CAPITAL OF OUR COMPANY) FOR SUBSCRIPTION BY ELIGIBLE EMPLOYEES (THE "EMPLOYEE RESERVATION PORTION"). OUR COMPANY AND THE SELLING SHAREHOLDERS, IN CONSULTATION WITH THE BRLMS, MAY OFFER A DISCOUNT OF UP TO [●]% OF THE OFFER PRICE TO ELIGIBLE EMPLOYEES BIDDING IN THE EMPLOYEE RESERVATION PORTION ("EMPLOYEE DISCOUNT"). THE OFFER LESS THE EMPLOYEE RESERVATION PORTION IS HEREINAFTER REFERRED TO AS THE "NET OFFER". THE OFFER AND THE NET OFFER SHALL CONSTITUTE [●]% AND [●]%, RESPECTIVELY, OF THE POST-OFFER PAID-UP EQUITY SHARE CAPITAL OF OUR COMPANY, RESPECTIVELY.

OUR COMPANY AND THE SELLING SHAREHOLDERS, IN CONSULTATION WITH THE BOOK RUNNING LEAD MANAGERS ("BRLMS"), MAY CONSIDER A FURTHER ISSUE OF EQUITY SHARES THROUGH A PREFERENTIAL ISSUE OR ANY OTHER METHOD AS MAY BE PERMITTED IN ACCORDANCE WITH APPLICABLE LAWS TO ANY PERSON(S), AGGREGATING UP TO ₹ 300.00 MILLION, AT ITS DISCRETION, PRIOR TO FILING OF THE RED HERRING PROSPECTUS WITH THE ROC ("PRE-IPO PLACEMENT"). IF THE PRE-IPO PLACEMENT IS COMPLETED, THE SIZE OF THE FRESH ISSUE WILL BE REDUCED TO THE EXTENT OF SUCH PRE-IPO PLACEMENT, SUBJECT TO THE OFFER CONSTITUTING AT LEAST [●]% OF THE POST-OFFER PAID UP EQUITY SHARE CAPITAL OF OUR COMPANY.

THE PRICE BAND, THE EMPLOYEE DISCOUNT (IF ANY) AND THE MINIMUM BID LOT WILL BE DECIDED BY OUR COMPANY AND THE SELLING SHAREHOLDERS IN CONSULTATION WITH THE BRLMS AND WILL BE ADVERTISED IN [●] EDITIONS OF [●] (A WIDELY CIRCULATED ENGLISH NATIONAL DAILY NEWSPAPER), [●] EDITIONS OF [●] (A WIDELY CIRCULATED HINDI NATIONAL DAILY NEWSPAPER) AND [●] EDITIONS OF [●] (A WIDELY CIRCULATED GUJARATI DAILY NEWSPAPER, GUJARATI BEING THE REGIONAL LANGUAGE OF GUJARAT WHERE OUR REGISTERED OFFICE IS LOCATED), AT LEAST TWO WORKING DAYS PRIOR TO THE BID/OFFER OPENING DATE AND SHALL BE MADE AVAILABLE TO BSE LIMITED ("BSE") AND NATIONAL STOCK EXCHANGE OF INDIA LIMITED ("NSE", TOGETHER WITH BSE, THE "STOCK EXCHANGES") FOR UPLOADING ON THEIR RESPECTIVE WEBSITES IN ACCORDANCE WITH THE SECURITIES AND EXCHANGE BOARD OF INDIA (ISSUE OF CAPITAL AND DISCLOSURE REQUIREMENTS) REGULATIONS, 2018, AS AMENDED (THE "SEBI ICDR REGULATIONS").

In case of any revision in the Price Band, the Bid/Offer Period will be extended by at least three additional Working Days after such revision in the Price Band, subject to the Bid/Offer Period not exceeding 10 Working Days. In cases of force majeure, banking strike or similar circumstances, our Company and the Selling Shareholders may, for reasons to be recorded in writing, extend the Bid /Offer Period for a minimum of three Working Days, subject to the Bid/Offer Period not exceeding 10 Working Days. Any revision in the Price Band and the revised Bid/Offer Period, if applicable, shall be widely disseminated by notification to the Stock Exchanges, by issuing a press release, and also by indicating the change on the respective websites of the BRLMs and at the terminals of the members of the Syndicate and by intimation to Designated Intermediaries and the Sponsor Bank, as applicable.

This Offer is being made through the Book Building Process, in terms of Rule 19(2)(b) of the Securities Contracts (Regulation) Rules, 1957, as amended ("SCRR") read with Regulation 31 of the SEBI ICDR Regulations and in compliance with Regulation 6(1) of the SEBI ICDR Regulations wherein not more than 50% of the Net Offer shall be available for allocation on a proportionate basis to Qualified Institutional Buyers ("QIBs") (the "QIB Portion"), provided that our Company and the Selling Shareholders in consultation with the BRLMs may allocate up to 60% of the QIB Portion to Anchor Investors on a discretionary basis ("Anchor Investor Portion"). One-third of the Anchor Investor Portion shall be reserved for domestic Mutual Funds, subject to valid Bids being received from the domestic Mutual Funds at or above the Anchor Investor Allocation Price in accordance with the SEBI ICDR Regulations. In the event of under-subscription or non-allocation in the Anchor Investor Portion, the balance Equity Shares shall be added to the QIB Portion (other than the Anchor Investor Portion) (the "Net QIB Portion"). Further, 5% of the Net QIB Portion shall be available for allocation on a proportionate basis to Mutual Funds only, and the remainder of the Net QIB Portion shall be available for allocation on a proportionate basis to all QIB Bidders, including Mutual Funds, subject to valid Bids being received at or above the Offer Price. However, if the aggregate demand from Mutual Funds is less than 5% of the Net QIB Portion, the balance Equity Shares available for allocation in the Mutual Fund Portion will be added to the remaining Net QIB Portion for proportionate allocation to QIBs. Further, not less than 15% of the Net Offer shall be available for allocation on a proportionate basis to Non-Institutional Investors and not less than 35% of the Net Offer shall be available for allocation to Retail Individual Investors in accordance with the SEBI ICDR Regulations, subject to valid Bids being received from them at or above the Offer Price. Further, Equity Shares will be allocated on a proportionate basis to Eligible Employees applying under the Employee Reservation Portion, subject to valid Bids received from them at or above the Offer Price. All Bidders, other than Anchor Investors, are required to participate in the Offer by mandatorily utilising the Application Supported by Blocked Amount ("ASBA") process by providing details of their respective ASBA Account (as defined hereinafter) in which the corresponding Bid Amounts will be blocked by the Self Certified Syndicate Banks ("SCSBs") or under the UPI Mechanism, as the case may be, to the extent of respective Bid Amounts. Anchor Investors are not permitted to participate in the Offer through the ASBA process. For details, see "Offer Procedure" on page 351.

### RISKS IN RELATION TO THE FIRST OFFER

This being the first public issue of Equity Shares of our Company, there has been no formal market for the Equity Shares of our Company. The face value of the Equity Shares is ₹ 5. The Offer Price, Floor Price or the Price Band should not be taken to be indicative of the market price of the Equity Shares after the Equity Shares are listed. No assurance can be given regarding active and/or sustained trading in the Equity Shares nor regarding the price at which the Equity Shares will be traded after listing.

### GENERAL RISK

Investments in equity and equity-related securities involve a degree of risk and investors should not invest any funds in the Offer unless they can afford to take the risk of losing their investment. Investors are advised to read the risk factors carefully before taking an investment decision in the Offer. For taking an investment decision, investors must rely on their own examination of our Company and the Offer, including the risks involved. The Equity Shares in the Offer have not been recommended or approved by the Securities and Exchange Board of India ("SEBI"), nor does SEBI guarantee the accuracy or adequacy of the contents of this Draft Red Herring Prospectus. Specific attention of the investors is invited to "Risk Factors" on page 28.

### ISSUER'S AND SELLING SHAREHOLDERS' ABSOLUTE RESPONSIBILITY

Our Company, having made all reasonable inquiries, accepts responsibility for and confirms that this Draft Red Herring Prospectus contains all information with regard to our Company and the Offer, which is material in the context of the Offer, that the information contained in this Draft Red Herring Prospectus is true and correct in all material aspects and is not misleading in any material respect, that the opinions and intentions expressed herein are honestly held and that there are no other facts, the omission of which makes this Draft Red Herring Prospectus as a whole or any of such information or the expression of any such opinions or intentions misleading in any material respect. Each of the Selling Shareholders severally, and not jointly, accepts responsibility for and confirms that the statements specifically made or confirmed by such Selling Shareholder in this Draft Red Herring Prospectus solely to the extent of information specifically pertaining to itself and its portion of the Equity Shares offered by it in the Offer for Sale, and assumes responsibility that such statements are true and correct in all material respects and are not misleading in any material respect. The Selling Shareholders, severally and not jointly, assume no responsibility for any other statements, including, *inter alia*, any of the statements made by or relating to our Company or any other Selling Shareholder.

### LISTING

The Equity Shares offered through the Red Herring Prospectus are proposed to be listed on the Stock Exchanges. Our Company has received 'in-principle' approvals from BSE and NSE for the listing of the Equity Shares pursuant to letters dated [●] and [●], respectively. For the purposes of the Offer, the Designated Stock Exchange shall be [●]. A copy of the Red Herring Prospectus and the Prospectus shall be filed with the RoC in accordance with Sections 26(4) and 32 of the Companies Act, 2013. For details of the material contracts and documents available for inspection from the date of the Red Herring Prospectus until the Bid/Offer Closing Date, see "Material Contracts and Documents for Inspection" on page 451.

### BOOK RUNNING LEAD MANAGERS

**AXIS CAPITAL**  
**Axis Capital Limited**  
 1<sup>st</sup> Floor, Axis House, C-2, Wadia International Centre  
 Pandurang Budhkar Marg, Worli  
 Mumbai 400 025, Maharashtra  
 Telephone: +91 22 4325 2183  
 Email: landmark.ipo@axiscap.in  
 Investor grievance e-mail: complaints@axiscap.in  
 Website: www.axiscapital.co.in  
 Contact person: Pratik Pednekar  
 SEBI registration number: INM000012029



**ICICI Securities Limited**  
 ICICI Venture House  
 Appasaheb Marathe Marg  
 Prabhadevi, Mumbai 400 025, Maharashtra  
 Telephone: +91 22 6807 7100  
 E-mail: landmark.ipo@icicisecurities.com  
 Investor grievance e-mail: customercare@icicisecurities.com  
 Website: www.icicisecurities.com  
 Contact person: Monank Mehta  
 SEBI registration number: MB/INM000011336

### REGISTRAR TO THE OFFER



**Link Intime India Private Limited**  
 C-101, 1<sup>st</sup> Floor, 247 Park  
 L.B.S. Marg  
 Vikhroli (West), Mumbai 400 083, Maharashtra  
 Telephone: +91 22 4918 6200  
 Email: landmark.ipo@linkintime.co.in  
 Investor grievance e-mail: landmark.ipo@linkintime.co.in  
 Website: www.linkintime.co.in  
 Contact person: Shanti Gopalkrishnan  
 SEBI registration number: INR000004058

### BID/OFFER PROGRAMME

**BID/OFFER OPENS ON**

[●]

**BID/OFFER CLOSURES ON**

[●]

\*Our Company and the Selling Shareholders in consultation with the BRLMs may consider participation by Anchor Investors in accordance with the SEBI ICDR Regulations. The Anchor Investor Bidding Date shall be one Working Day prior to the Bid/Offer Opening Date.

\*\*Our Company and the Selling Shareholders in consultation with the BRLMs may consider closing the Bid/Offer Period for QIBs one Working Day prior to the Bid/Offer Closing Date in accordance with the SEBI ICDR Regulations.

## TABLE OF CONTENTS

<b>SECTION I – GENERAL</b> .....	2
<b>DEFINITIONS AND ABBREVIATIONS</b> .....	2
<b>CERTAIN CONVENTIONS, USE OF FINANCIAL INFORMATION, INDUSTRY AND MARKET DATA     AND CURRENCY OF PRESENTATION</b> .....	16
<b>FORWARD-LOOKING STATEMENTS</b> .....	19
<b>SUMMARY OF THIS OFFER DOCUMENT</b> .....	21
<b>SECTION II - RISK FACTORS</b> .....	28
<b>SECTION III – INTRODUCTION</b> .....	60
<b>THE OFFER</b> .....	60
<b>SUMMARY FINANCIAL INFORMATION</b> .....	62
<b>GENERAL INFORMATION</b> .....	68
<b>CAPITAL STRUCTURE</b> .....	76
<b>SECTION IV – PARTICULARS OF THE OFFER</b> .....	89
<b>OBJECTS OF THE OFFER</b> .....	89
<b>BASIS FOR THE OFFER PRICE</b> .....	99
<b>STATEMENT OF SPECIAL TAX BENEFITS</b> .....	101
<b>SECTION V - ABOUT OUR COMPANY</b> .....	105
<b>INDUSTRY OVERVIEW</b> .....	105
<b>OUR BUSINESS</b> .....	133
<b>KEY REGULATIONS AND POLICIES IN INDIA</b> .....	161
<b>HISTORY AND CERTAIN CORPORATE MATTERS</b> .....	166
<b>OUR SUBSIDIARIES</b> .....	173
<b>OUR MANAGEMENT</b> .....	178
<b>OUR PROMOTER AND PROMOTER GROUP</b> .....	196
<b>GROUP COMPANIES</b> .....	199
<b>DIVIDEND POLICY</b> .....	201
<b>SECTION VI – FINANCIAL INFORMATION</b> .....	202
<b>RESTATED CONSOLIDATED FINANCIAL INFORMATION</b> .....	202
<b>OTHER FINANCIAL INFORMATION</b> .....	269
<b>CAPITALISATION STATEMENT</b> .....	270
<b>RELATED PARTY TRANSACTIONS</b> .....	271
<b>MANAGEMENT’S DISCUSSION AND ANALYSIS OF FINANCIAL POSITION AND RESULTS     OF OPERATIONS</b> .....	272
<b>FINANCIAL INDEBTEDNESS</b> .....	311
<b>SECTION VII – LEGAL AND OTHER INFORMATION</b> .....	314
<b>OUTSTANDING LITIGATION AND OTHER MATERIAL DEVELOPMENTS</b> .....	314
<b>GOVERNMENT AND OTHER APPROVALS</b> .....	328
<b>OTHER REGULATORY AND STATUTORY DISCLOSURES</b> .....	331
<b>SECTION VIII – OFFER RELATED INFORMATION</b> .....	341
<b>TERMS OF THE OFFER</b> .....	341
<b>OFFER STRUCTURE</b> .....	347
<b>OFFER PROCEDURE</b> .....	351
<b>RESTRICTIONS ON FOREIGN OWNERSHIP OF INDIAN SECURITIES</b> .....	369
<b>SECTION IX - MAIN PROVISIONS OF THE ARTICLES OF ASSOCIATION</b> .....	371
<b>SECTION X - OTHER INFORMATION</b> .....	451
<b>MATERIAL CONTRACTS AND DOCUMENTS FOR INSPECTION</b> .....	451
<b>DECLARATION</b> .....	454

## SECTION I – GENERAL

### DEFINITIONS AND ABBREVIATIONS

*This Draft Red Herring Prospectus uses certain definitions and abbreviations which, unless the context otherwise indicates or implies, or unless otherwise specified, shall have the meaning as provided below. References to any legislation, act, regulation, rules, guidelines or policies shall be to such legislation, act, regulation, rule, guidelines or policy and will include any amendments, clarifications, modifications, replacements or re-enactments thereto, from time to time and any reference to a statutory provision shall include any subordinate legislation made from time to time under that provision.*

*In case of any inconsistency between the definitions given below and the definitions contained in the General Information Document (as defined below), the definitions given below shall prevail.*

*The words and expressions used in this Draft Red Herring Prospectus but not defined herein, shall have, to the extent applicable, the meanings ascribed to such terms under the Companies Act, the SEBI ICDR Regulations, the SCRA, the Depositories Act or the rules and regulations made thereunder.*

*Notwithstanding the foregoing, terms in “Main Provisions of the Articles of Association”, “Statement of Special Tax Benefits”, “Industry Overview”, “Basis for the Offer Price”, “Key Regulations and Policies in India”, “Restated Consolidated Financial Information” and “Outstanding Litigation and Other Material Developments”, on pages 371, 100, 105, 99, 161, 202 and 314 will have the meaning ascribed to such terms in those respective sections.*

#### General terms

Term	Description
our Company / the Company / Parent/ the Issuer	Landmark Cars Limited, a public limited company incorporated under the Companies Act, 1956 and having its Registered Office at Landmark House, Opp. AEC, S.G. Highway, Thaltej, Near Gurudwara Ahmedabad 380 059 Gujarat, India
we/us/our	Unless the context otherwise indicates or implies, refers to our Company together with our Subsidiaries, on a consolidated basis

#### Company and Selling Shareholders related terms

Term	Description
AMPL	Automark Motors Private Limited
AoA/ Articles of Association/ Articles	The articles of association of our Company, as amended
Audit Committee	Audit committee of the Board, described in “ <i>Our Management-Corporate Governance</i> ” on page 186
Auditors/ Statutory Auditors	The statutory auditors of our Company, currently being Deloitte Haskins & Sells, Chartered Accountants
BMPL	Benchmark Motors Private Limited
Board/ Board of Directors	The board of directors of our Company, or a duly constituted committee thereof
BYD	BYD India Private Limited
Chief Financial Officer/ CFO	Chief financial officer of our Company, Surendra Kumar Agarwal
Company Secretary and Compliance Officer	Company secretary and compliance officer of our Company, Amol Arvind Rajee
CSR Committee/ Corporate Social Responsibility Committee	The corporate social responsibility committee of our Company, described in “ <i>Our Management-Corporate Governance</i> ” on page 186
Director(s)	The director(s) on our Board
ESOP Scheme / Employee Stock Option Scheme	Landmark Cars Limited Employee Stock Option Scheme
Equity Shares	The equity shares of our Company of face value of ₹ 5 each
Executive Director(s)	Executive Directors on the Board, currently Sanjay Karsandas Thakker and Aryaman Sanjay Thakker
Executive Whole-Time Director	Executive Whole-Time Director on the Board, currently, Paras Somani

<b>Term</b>	<b>Description</b>
Group Companies	The group companies of our Company, namely Wild Dreams Media and Communications Private Limited, Landmark Insurance Brokers Private Limited, and Landmark Pre-Owned Cars Private Limited as disclosed in “ <i>Group Companies</i> ” on page 199
Group Landmark	Group Landmark includes all automobile businesses of the group, carried out by our Company, Automark Motors Private Limited, Landmark Automobiles Private Limited, Landmark Commercial Vehicles Private Limited, Landmark Cars (East) Private Limited, Landmark Lifestyle Cars Private Limited, Benchmark Motors Private Limited and Watermark Cars Private Limited
Independent Director(s)	Independent directors of our Company, Gautam Yogendra Trivedi, Sucheta Nilesh Shah, Manish Balkishan Chokhani and Ramakant Sharma
Individual Selling Shareholder	Garima Misra
Investor Director	Akshay Tanna
Investor Selling Shareholder /TPG Growth	TPG Growth II SF Pte. Ltd.
IPO Committee	The IPO committee of our Board
Key Managerial Personnel/ KMP	Key managerial personnel of our Company in terms of Regulation 2(1)(bb) of the SEBI ICDR Regulations and Section 2(51) of the Companies Act, 2013 as applicable and as further described in “ <i>Our Management-Key Managerial Personnel</i> ” on page 194
Kolkata Shares Subscription and Shareholders Agreement	Shares Subscription and Shareholders Agreement dated February 14, 2013, entered into between Sanjay Karsandas Thakker, Ami Sanjay Thakker, Landmark Cars (East) Private Limited, Autocity Services Private Limited, and our Company
LAPL	Landmark Automobiles Private Limited
LCEPL	Landmark Cars (East) Private Limited
LCVPL	Landmark Commercial Vehicles Private Limited
LIBPL	Landmark Insurance Brokers Private Limited
LLCPL	Landmark Lifestyle Cars Private Limited
LPOCPL	Landmark Pre-Owned Cars Private Limited
Materiality Policy	The policy adopted by our Board on January 11, 2022, for identification of material: (a) outstanding litigation proceedings; (b) group companies; and (c) material creditors, pursuant to the requirements of the SEBI ICDR Regulations and for the purposes of disclosure in this Draft Red Herring Prospectus, the Red Herring Prospectus and Prospectus
Material Subsidiaries	The material subsidiaries of our Company, namely Automark Motors Private Limited, Benchmark Motors Private Limited, Landmark Automobiles Private Limited, Landmark Commercial Vehicles Private Limited, and Landmark Lifestyle Cars Private Limited as disclosed in “ <i>Our Subsidiaries</i> ” on page 173
Memorandum of Association/ MoA	The memorandum of association of our Company, as amended
NCLT Order	Order dated April 4, 2019 read with order dated April 15, 2019 by National Company Law Tribunal, Ahmedabad, approving and sanctioning Scheme of Arrangement- I, Scheme of Arrangement- II and Scheme of Arrangement- III
Nomination and Remuneration Committee/ NRC	The nomination and remuneration committee of our Company, described in “ <i>Our Management - Corporate Governance</i> ” on page 186
Non-Executive Director(s)	Non-executive directors on our Board, currently Akshay Tanna, Gautam Yogendra Trivedi, Sucheta Nilesh Shah, Manish Balkishan Chokhani and Ramakant Sharma
Other Selling Shareholders	Sanjay Karsandas Thakker HUF and Aastha Limited
Promoter	The Promoter of our Company, being Sanjay Karsandas Thakker. For details, see “ <i>Our Promoter and Promoter Group</i> ” on page 196
Promoter Group	Persons and entities constituting the promoter group of our Company, pursuant to Regulation 2(1)(pp) of the SEBI ICDR Regulations and as disclosed in “ <i>Our Promoter and Promoter Group</i> ” on page 196
Registered Office	The registered office of our Company, situated at Landmark House, Opp. AEC, S.G. Highway, Thaltej, Near Gurudwara, Ahmedabad 380 059, Gujarat, India
Restated Consolidated Financial Information	The restated consolidated financial information of our Company and our Subsidiaries which comprises the restated consolidated statement of assets and liabilities as at September 30, 2021, March 31, 2021, March 31, 2020 and March 31, 2019; the restated consolidated statement of profit and loss (including other comprehensive income); the

<b>Term</b>	<b>Description</b>
	restated consolidated statement of changes in equity; the restated consolidated statement of cash flows for the six months ended September 30, 2021 and the Fiscals ended March 31, 2021, March 31, 2020 and March 31, 2019 and the summary of significant accounting policies and other explanatory information prepared in terms of the requirements of Section 26 of Part I of the Chapter III of the Companies Act, the SEBI ICDR Regulations and the Guidance Note on Reports in Company Prospectuses (Revised 2019) issued by the ICAI, as amended from time to time (the “ <i>Guidance Note</i> ”) read with the general directions dated October 28, 2021 received from Securities and Exchange Board of India (SEBI) by the Company through BRLMs (the “ <i>SEBI Communication</i> ”), as applicable
Risk Management Committee /RMC	The risk management committee of our Company, described in “ <i>Our Management-Corporate Governance</i> ” on page 186
RoC	Registrar of Companies, Gujarat, Dadra & Nagar Haveli at Ahmedabad
RoC, Mumbai	Registrar of Companies, Maharashtra at Mumbai
Scheme of Arrangement-I	Composite scheme of arrangement and amalgamation in the nature of demerger and amalgamation between our Company, Automark Motors Private Limited and Watermark Vehicles Private Limited and their respective shareholders and creditors, approved and sanctioned by the National Company Law Tribunal, Ahmedabad by way of its order dated April 4, 2019, read with order dated April 15, 2019
Scheme of Arrangement-II	Composite scheme of arrangement and amalgamation in the nature of demerger and amalgamation between our Company, Landmark Automobiles Private Limited and Watermark Automobiles Private Limited and their respective shareholders and creditors, approved and sanctioned by the National Company Law Tribunal, Ahmedabad by way of its order dated April 4, 2019, read with order dated April 15, 2019
Scheme of Arrangement-III	Composite scheme of arrangement and amalgamation in the nature of demerger and amalgamation between our Company, Landmark Commercial Vehicles Private Limited and Watermark Commercial Vehicles Private Limited and their respective shareholders and creditors, approved and sanctioned by the National Company Law Tribunal, Ahmedabad by way of its order dated April 4, 2019, read with order dated April 15, 2019
Schemes of Arrangement	Collectively, Scheme of Arrangement-I, Scheme of Arrangement-II and Scheme of Arrangement-III
Selling Shareholders	The Selling Shareholders participating in the Offer, being TPG Growth, Sanjay Karsandas Thakker HUF, Aastha Limited and Garima Misra
Shareholders	The holders of the Equity Shares, from time to time
Shareholders Agreement	Shareholders Agreement entered into between TPG Growth, Sanjay Karsandas Thakker, Ami Sanjay Thakker and our Company as amended by the amendment agreements dated January 29, 2016, and September 30, 2018 and the Waiver cum Amendment Agreement
Stakeholders Relationship Committee/SRC	The stakeholders’ relationship committee of our Company, described in “ <i>Our Management-Corporate Governance</i> ” on page 186
Subsidiaries	The subsidiaries of our Company as on the date of this Draft Red Herring Prospectus, as set out in “ <i>Our Subsidiaries</i> ” on page 173
Waiver cum Amendment Agreement	Waiver cum amendment agreement to the Shareholders Agreement dated January 11, 2022, entered into between TPG Growth, Sanjay Karsandas Thakker, Ami Sanjay Thakker and our Company
WCPL	Watermark Cars Private Limited
WDMCPL	Wild Dreams Media and Communications Private Limited
YBLR	YES Bank Lending Rate

#### Offer related terms

<b>Term</b>	<b>Description</b>
Acknowledgement Slip	The slip or document issued by a Designated Intermediary(ies) to a Bidder as proof of registration of the Bid cum Application Form

<b>Term</b>	<b>Description</b>
Allot/ Allotment/ Allotted	Unless the context otherwise requires, allotment of Equity Shares pursuant to the Fresh Issue and transfer of the Offered Shares by the Selling Shareholders pursuant to the Offer for Sale to successful Bidders
Allotment Advice	Note or advice or intimation of Allotment sent to the successful Bidders who have been or are to be Allotted the Equity Shares after the Basis of Allotment has been approved by the Designated Stock Exchange
Allottee	A successful Bidder to whom the Equity Shares are Allotted
Anchor Investor	A Qualified Institutional Buyer, applying under the Anchor Investor Portion in accordance with the requirements specified in the SEBI ICDR Regulations and the Red Herring Prospectus
Anchor Investor Allocation Price	The price at which Equity Shares will be allocated to Anchor Investors in terms of the Red Herring Prospectus and Prospectus, which will be decided by our Company and the Selling Shareholders, in consultation with the BRLMs during the Anchor Investor Bidding Date
Anchor Investor Application Form	The application form used by an Anchor Investor to make a Bid in the Anchor Investor Portion and which will be considered as an application for Allotment in accordance with the requirements specified under the SEBI ICDR Regulations and the Red Herring Prospectus
Anchor Investor Bidding Date	The day, being one Working Day prior to the Bid/Offer Opening Date, on which Bids by Anchor Investors shall be submitted, prior to and after which the BRLMs will not accept any Bids from Anchor Investors, and allocation to Anchor Investors shall be completed
Anchor Investor Offer Price	Final price at which the Equity Shares will be issued and Allotted to Anchor Investors in terms of the Red Herring Prospectus and the Prospectus, which price will be equal to or higher than the Offer Price but not higher than the Cap Price. The Anchor Investor Offer Price will be decided by our Company and the Selling Shareholders, in consultation with the BRLMs
Anchor Investor Portion	Up to 60% of the QIB Portion which may be allocated by our Company and the Selling Shareholders in consultation with the BRLMs, to Anchor Investors on a discretionary basis, in accordance with the SEBI ICDR Regulations. One-third of the Anchor Investor Portion shall be reserved for domestic Mutual Funds, subject to valid Bids being received from domestic Mutual Funds at or above the Anchor Investor Allocation Price in accordance with the SEBI ICDR Regulations
Anchor Investor Pay-In Date	With respect to Anchor Investor(s), it shall be the Anchor Investor Bidding Date, and in the event the Anchor Investor Allocation Price is lower than the Offer Price, not later than two Working Days after the Bid/Offer Closing Date
Application Supported by Blocked Amount/ ASBA	An application, whether physical or electronic, used by ASBA Bidders to make a Bid and authorize an SCSB to block the Bid Amount in the relevant ASBA Account and will include applications made by RIIs using the UPI Mechanism where the Bid Amount will be blocked upon acceptance of UPI Mandate Request by RIIs using the UPI Mechanism
ASBA Account	A bank account maintained by an ASBA Bidder with an SCSB and specified in the ASBA Form submitted by such ASBA Bidder in which funds will be blocked by such SCSB to the extent of the specified in the ASBA Form submitted by such ASBA Bidder and includes a bank account maintained by an RII linked to a UPI ID, which will be blocked by the SCSB upon acceptance of the UPI Mandate Request in relation to a Bid by a Retail Individual Investor Bidding through the UPI Mechanism
ASBA Bidders	All Bidders except Anchor Investors
ASBA Form	An application form, whether physical or electronic, used by ASBA Bidders to submit Bids, which will be considered as the application for Allotment in terms of the Red Herring Prospectus and the Prospectus
Axis Capital	Axis Capital Limited
Banker(s) to the Offer	Collectively, the Escrow Collection Bank(s), Refund Bank(s), Sponsor Bank(s) and Public Offer Account Bank(s), as the case may be
Basis of Allotment	Basis on which Equity Shares will be Allotted to successful Bidders under the Offer, as described in “Offer Procedure” beginning on page 351
Bid	An indication to make an offer during the Bid/Offer Period by an ASBA Bidder pursuant to submission of the ASBA Form, or during the Anchor Investor Bidding Date

Term	Description
	by an Anchor Investor pursuant to submission of the Anchor Investor Application Form, to subscribe to or purchase the Equity Shares at a price within the Price Band, including all revisions and modifications thereto as permitted under the SEBI ICDR Regulations and in terms of the Red Herring Prospectus and the relevant Bid cum Application Form. The term “Bidding” shall be construed accordingly
Bid Amount	<p>The highest value of optional Bids indicated in the Bid cum Application Form and payable by the Bidder and, in the case of RIIs Bidding at the Cut off Price, the Cap Price multiplied by the number of Equity Shares Bid for by such RIIs and mentioned in the Bid cum Application Form and payable by the Bidder or blocked in the ASBA Account of the ASBA Bidders, as the case maybe, upon submission of the Bid in the Offer, as applicable.</p> <p>However, Eligible Employees applying in the Employee Reservation Portion can apply at the Cut-off Price and the Bid Amount shall be Cap Price net of Employee Discount, multiplied by the number of Equity Shares Bid for by such Eligible Employee and mentioned in the Bid cum Application Form</p>
Bid cum Application Form	The Anchor Investor Application Form or the ASBA Form, as the context requires
Bid Lot	[●] Equity Shares and in multiples of [●] Equity Shares thereafter
Bid/Offer Closing Date	<p>Except in relation to any Bids received from the Anchor Investors, the date after which the Designated Intermediaries will not accept any Bids, being [●], which shall be published in [●] editions of [●] (a widely circulated English national daily newspaper), [●] editions of [●] (a widely circulated Hindi national daily newspaper), and [●] editions of [●] (a widely circulated Gujarati daily newspaper) (Gujarati being the regional language of Gujarat, where our Registered Office is located).</p> <p>Our Company and the Selling Shareholders, in consultation with the BRLMs, may, consider closing the Bid/Offer Period for QIBs one Working Day prior to the Bid/Offer Closing Date in accordance with the SEBI ICDR Regulations. In case of any revision, the extended Bid/ Offer Closing Date shall be widely disseminated by notification to the Stock Exchanges, and also be notified on the websites of the BRLMs and at the terminals of the Syndicate Members and communicated to the Designated Intermediaries and the Sponsor Bank, which shall also be notified in an advertisement in same newspapers in which the Bid/ Offer Opening Date was published, as required under the SEBI ICDR Regulations</p>
Bid/Offer Opening Date	Except in relation to any Bids received from the Anchor Investors, the date on which the Designated Intermediaries shall start accepting Bids, being [●], which shall be published in [●] editions of [●] (a widely circulated English national daily newspaper), [●] editions of [●] (a widely circulated Hindi national daily newspaper), and [●] editions of [●], a widely circulated Gujarati daily newspaper (Gujarati being the regional language of Gujarat, where our Registered Office is located)
Bid/ Offer Period	<p>Except in relation to Bids by Anchor Investors, the period between the Bid/Offer Opening Date and the Bid/Offer Closing Date, inclusive of both days, during which prospective Bidders can submit their Bids, including any revisions thereof, in accordance with the SEBI ICDR Regulations and in terms of the Red Herring prospectus. Provided that the Bidding shall be kept open for a minimum of three Working Days for all categories of Bidders, other than Anchor Investors.</p> <p>In cases of force majeure, banking strike or similar circumstances, our Company may, for reasons to be recorded in writing, extend the Bid/Offer Period for a minimum of three Working Days, subject to the Bid/Offer Period not exceeding 10 Working Days</p>
Bidder	Any prospective investor who makes a Bid pursuant to the terms of the Red Herring Prospectus and the Bid cum Application Form and unless otherwise stated or implied, includes an Anchor Investor
Bidding Centers	Centers at which the Designated Intermediaries shall accept the ASBA Forms, i.e., Designated SCSB Branches for SCSBs, Specified Locations for Syndicate, Broker Centres for Registered Brokers, Designated RTA Locations for CRTAs and Designated CDP Locations for CDPs
Book Building Process	Book building process, as provided in Part A of Schedule XIII of the SEBI ICDR Regulations, in terms of which the Offer is being made



<b>Term</b>	<b>Description</b>
Book Running Lead Managers/ BRLMs	The book running lead managers to the Offer namely, Axis Capital Limited and ICICI Securities Limited
Broker Centres	Broker centres of the Registered Brokers where ASBA Bidders can submit the ASBA Forms, provided that Retail Individual Investors may only submit ASBA Forms at such broker centres if they are Bidding using the UPI Mechanism. The details of such broker centres, along with the names and contact details of the Registered Brokers, are available on the respective websites of the Stock Exchanges (www.bseindia.com and www.nseindia.com)
CAN/ Confirmation of Allocation Note	Notice or intimation of allocation of the Equity Shares sent to Anchor Investors, who have been allocated the Equity Shares, on/after the Anchor Investor Bidding Date
Cap Price	The higher end of the Price Band, above which the Offer Price and the Anchor Investor Offer Price will not be finalised and above which no Bids will be accepted including any revisions thereof. The Cap Price shall be atleast 105% of the Floor Price.
Client ID	Client identification number maintained with one of the Depositories in relation to the Bidder's beneficiary account
Collecting Depository Participant/ CDP	A depository participant as defined under the Depositories Act, 1996, registered with SEBI and who is eligible to procure Bids at the Designated CDP Locations in terms of the circular no. CIR/CFD/POLICYCELL/11/2015 dated November 10, 2015, and the SEBI UPI Circulars, issued by SEBI and as per the list available on the websites of BSE and NSE, as updated from time to time
Collecting Registrar and Share Transfer Agents/ CRTAs	Registrar and share transfer agents registered with SEBI and eligible to procure Bids at the Designated RTA Locations in terms of, among others, circular no. CIR/CFD/POLICYCELL/11/2015 dated November 10, 2015 as per the list available on the respective websites of BSE and NSE, as updated from time to time and the UPI Circulars issued by SEBI
Cut-off Price	The Offer Price as finalised by our Company and the Selling Shareholders, in consultation with the BRLMs, which shall be any price within the Price Band.  Only Retail Individual Investors and Eligible Employees Bidding under the Employee Reservation Portion are entitled to Bid at the Cut-off Price. QIBs (including Anchor Investors) and Non-Institutional Investors are not entitled to Bid at the Cut-off Price
Demographic Details	Details of the Bidders including the Bidder's address, name of the Bidder's father/husband, investor status, occupation and bank account details and UPI ID, where applicable
Designated CDP Locations	Such locations of the CDPs where Bidders (other than Anchor Investors) can submit the ASBA Forms. The details of such Designated CDP Locations, along with names and contact details of the Collecting Depository Participants eligible to accept ASBA Forms are available on the respective websites of the Stock Exchanges (www.bseindia.com and www.nseindia.com)
Designated Date	The date on which funds are transferred from the Escrow Account and the amounts blocked are transferred from the ASBA Accounts, as the case may be, to the Public Offer Account or the Refund Account, and the instructions are issued to the SCSBs (in case of RIIs using the UPI Mechanism, instructions issued through the Sponsor Bank) for the transfer of amounts blocked by the SCSBs in the ASBA Accounts to the Public Offer Account or the Refund Account, as the case may be, in terms of the Red Herring Prospectus and the Prospectus, after the finalisation of the Basis of Allotment in consultation with the Designated Stock Exchange, following which the Board of Directors may Allot Equity Shares to successful Bidders in the Offer
Designated Intermediaries	In relation to ASBA Forms submitted by RIIs by authorizing an SCSB to block the Bid Amount in the ASBA Account, Designated Intermediaries shall mean SCSBs.  In relation to ASBA Forms submitted by RIIs where the Bid Amount will be blocked upon acceptance of UPI Mandate Request by such RII using the UPI Mechanism, Designated Intermediaries shall mean Syndicate, sub-syndicate, Registered Brokers, CDPs and CRTAs.  In relation to ASBA Forms submitted by QIBs and NIIs, Designated Intermediaries shall mean SCSBs, Syndicate, sub-syndicate, Registered Brokers, CDPs and CRTAs

<b>Term</b>	<b>Description</b>
Designated RTA Locations	Such locations of the CRTAs where Bidders (other than Anchor Investors) can submit the ASBA Forms to the CRTAs. The details of such Designated CRTA Locations, along with names and contact details of the CRTAs eligible to accept ASBA Forms are available on the respective websites of the Stock Exchanges (www.bseindia.com and www.nseindia.com), as updated from time to time
Designated SCSB Branches	Such branches of the SCSBs which shall collect the ASBA Forms, a list of which is available on the website of SEBI at <a href="https://www.sebi.gov.in/sebiweb/other/OtherAction.do?doRecognised=yes">https://www.sebi.gov.in/sebiweb/other/OtherAction.do?doRecognised=yes</a> or at such other website as may be prescribed by SEBI from time to time
Designated Stock Exchange	[●]
Draft Red Herring Prospectus/ DRHP	This draft red herring prospectus dated January 18, 2022, issued in accordance with the SEBI ICDR Regulations, which does not contain complete particulars of the price at which the Equity Shares will be Allotted and the size of the Offer including any addenda or corrigenda thereto
Eligible Employee(s)	<p>Permanent employees of our Company or of our Subsidiaries, as may be decided (excluding such employees not eligible to invest in the Offer under applicable laws, rules, regulations and guidelines), as on the date of filing of the Red Herring Prospectus with the RoC and who continue to be a permanent employee of our Company or our Subsidiaries, as applicable, until the submission of the ASBA Form and is based, working and present in India or abroad as on the date of submission of the ASBA Form, but not including (i) our Promoter; (ii) persons belonging to our Promoter Group; or (iii) Directors who either themselves or through their relatives or through any body corporate, directly or indirectly, hold more than 10% of the outstanding Equity Shares of our Company.</p> <p>The maximum Bid Amount under the Employee Reservation Portion by an Eligible Employee shall not exceed ₹ 500,000. However, the initial Allotment to an Eligible Employee in the Employee Reservation Portion shall not exceed ₹ 200,000. Only in the event of an under-subscription in the Employee Reservation Portion, such unsubscribed portion may be available for allocation and Allotment on a proportionate basis to Eligible Employees Bidding in the Employee Reservation Portion, for a value in excess of ₹ 200,000 subject to the total Allotment to an Eligible Employee not exceeding ₹ 500,000</p>
Eligible FPI(s)	FPIs that are eligible to participate in this Offer in terms of applicable laws
Eligible NRI(s)	A non-resident Indian, resident in a jurisdiction outside India where it is not unlawful to make an offer or invitation under the Offer and in relation to whom the Red Herring Prospectus and the Bid Cum Application Form constitutes an invitation to subscribe to or purchase the Equity Shares offered thereby
Employee Discount	Our Company and the Selling Shareholders, in consultation with the BRLMs, may offer a discount of up to [●] % to the Offer Price (equivalent of ₹ [●] per Equity Share) to Eligible Employees and which shall be announced at least two Working Days prior to the Bid / Offer Opening Date
Employee Reservation Portion	The portion of the Offer being up to [●] Equity Shares, aggregating to ₹ [●], which shall not exceed [●]% of the post Offer Equity Share capital of our Company, available for allocation to Eligible Employees, on a proportionate basis
Escrow Account(s)	Account(s) to be opened with the Escrow Collection Bank(s) and in whose favour the Anchor Investors will transfer money through direct credit/NEFT/RTGS/NACH in respect of the Bid Amount when submitting a Bid
Escrow and Sponsor Bank Agreement	The agreement to be entered into amongst our Company, the Selling Shareholders, the Registrar to the Offer, the BRLMs, and Banker(s) to the Offer, <i>inter alia</i> , collection of the Bid Amounts from Anchor Investors, transfer of funds to the Public Offer Account(s) and where applicable remitting refunds of the amounts collected from the Bidders, if any, to such Bidders, on the terms and conditions thereof
Escrow Collection Bank(s)	The bank(s) which are clearing members and registered with SEBI as bankers to an issue and with whom the Escrow Account(s) will be opened, in this case being [●]
First Bidder	Bidder whose name shall be mentioned in the Bid cum Application Form or the Revision Form and in case of joint Bids, whose name shall also appear as the first holder of the beneficiary account held in joint names

<b>Term</b>	<b>Description</b>
Floor Price	The lower end of the Price Band, subject to any revision(s) thereto, at or above which the Offer Price and the Anchor Investor Offer Price will be finalised and below which no Bids will be accepted
Fresh Issue	The fresh issue of up to [●] Equity Shares by our Company, at ₹ [●] per Equity Share (including a premium of ₹ [●] per Equity Share) aggregating up to ₹ 1,500 million as part of the Offer
General Information Document	The General Information Document for investing in public offers, prepared and issued in accordance with the circular (SEBI/HO/CFD/DIL1/CIR/P/2020/37) dated March 17, 2020, issued by SEBI, suitably modified and updated pursuant to the UPI Circulars and any subsequent circulars or notifications issued by SEBI from time to time.
Mobile App(s)	The mobile applications listed on the website of SEBI at <a href="https://www.sebi.gov.in/sebiweb/other/OtherAction.do?doRecognisedFpi=yes&amp;intmid=43">https://www.sebi.gov.in/sebiweb/other/OtherAction.do?doRecognisedFpi=yes&amp;intmid=43</a> or such other website as may be updated from time to time, which may be used by RIIs to submit Bids using the UPI Mechanism
Monitoring Agency	[●]
Mutual Fund Portion	5% of the Net QIB Portion, or [●] Equity Shares, which shall be available for allocation to Mutual Funds only on a proportionate basis, subject to valid Bids being received at or above the Offer Price
Mutual Funds	Mutual funds registered with SEBI under the Securities and Exchange Board of India (Mutual Funds) Regulations, 1996
Net Offer	The Offer less the Employee Reservation Portion
Net Proceeds	Proceeds of the Fresh Issue less Company's share of Offer expenses. For further details, see " <i>Objects of the Offer</i> " on page 89
Net QIB Portion	The portion of the QIB Portion less the number of Equity Shares Allotted to the Anchor Investors
Non-Institutional Investors/ NIIs	All Bidders that are not QIBs or RIIs and who have Bid for Equity Shares for an amount of more than ₹200,000 (but not including NRIs other than Eligible NRIs)
Non-Institutional Portion	The portion of the Offer being not less than 15% of the Net Offer, consisting of [●] Equity Shares, which shall be available for allocation on a proportionate basis to Non-Institutional Investors, subject to valid Bids being received at or above the Offer Price
Non-Resident	A person resident outside India, as defined under FEMA and includes NRIs, FPIs and FVCIs
Offer	<p>The initial public offering of up to [●] Equity Shares of face value of ₹ 5 each for cash at a price of ₹ [●] each (including a share premium of ₹ [●] each), aggregating up to ₹ 7,620.00 million comprising the Fresh Issue and the Offer for Sale</p> <p>Our Company and the Selling Shareholders, in consultation with the BRLMs, may consider the Pre-IPO Placement aggregating up to ₹ 300.00 million. If the Pre-IPO Placement is completed, the size of the Fresh Issue will be reduced to the extent of such Pre-IPO Placement, subject to the Offer constituting at least [●]% of the post-Offer paid up Equity Share capital of our Company</p>
Offer Agreement	The agreement dated January 17, 2022, amongst our Company, the Selling Shareholders and the BRLMs, pursuant to which certain arrangements are agreed to in relation to the Offer
Offer for Sale	The offer for sale of up to [●] Equity Shares at ₹ [●] per Equity Share aggregating up to ₹ 6,120 million by the Selling Shareholders
Offer Price	<p>₹ [●] per Equity Share, being the final price within the Price Band, at which Equity Shares will be Allotted to successful Bidders, other than Anchor Investors. Equity Shares will be Allotted to Anchor Investors at the Anchor Investor Offer Price in terms of the Red Herring Prospectus. The Offer Price will be decided by our Company and the Selling Shareholders, in consultation with the BRLMs on the Pricing Date, in accordance with the Book Building Process and in terms of the Red Herring Prospectus.</p> <p>A discount of up to [●]% on the Offer Price (equivalent of ₹ [●] per Equity Share) may be offered to Eligible Employees bidding in the Employee Reservation Portion. This Employee Discount, if any, will be decided by our Company and the Selling Shareholders, in consultation with the BRLMs</p>

<b>Term</b>	<b>Description</b>
Offered Shares	The cumulative number of Equity Shares being offered by the Selling Shareholders in the Offer for Sale comprising of an aggregate of up to [●] Equity Shares aggregating up to ₹ 6,120 million
Pre-IPO Placement	A further issue of Equity Shares, through a preferential offer or any other method as may be permitted in accordance with applicable law, aggregating up to ₹ 300.00 million, which may be undertaken by our Company and the Selling Shareholders, in consultation with the BRLMs, prior to the filing of the Red Herring Prospectus with the RoC
Price Band	Price band of a minimum price of ₹[●] per Equity Share (Floor Price) and the maximum price of ₹[●] per Equity Share (Cap Price) including any revisions thereof. The Price Band, Employee Discount (if any) and the minimum Bid Lot for the Offer will be decided by our Company and the Selling Shareholders, in consultation with the BRLMs, and will be advertised in [●] editions of [●] (a widely circulated English national daily newspaper), [●] editions of [●] (a widely circulated Hindi national daily newspaper) and [●] editions of [●] (a widely circulated Gujarati daily newspaper, Gujarati also being the regional language of Gujarat, where our Registered Office is situated) at least two Working Days prior to the Bid/Offer Opening Date, with the relevant financial ratios calculated at the Floor Price and at the Cap Price, and shall be made available to the Stock Exchanges for the purpose of uploading on their respective websites
Pricing Date	The date on which our Company and the Selling Shareholders in consultation with the BRLMs, will finalise the Offer Price
Prospectus	The Prospectus to be filed with the RoC in accordance with the Companies Act, 2013, and the SEBI ICDR Regulations containing, <i>inter alia</i> , the Offer Price that is determined at the end of the Book Building Process, the size of the Offer and certain other information, including any addenda or corrigenda thereto
Public Offer Account(s)	The bank account(s) to be opened with the Public Offer Account Bank(s) under Section 40(3) of the Companies Act, 2013, to receive monies from the Escrow Account(s) and ASBA Accounts on the Designated Date
Public Offer Account Bank(s)	The bank(s) which are clearing members and registered with SEBI under the SEBI BTI Regulations and with which the Public Offer Account(s) is opened for collection of Bid Amounts from Escrow Account(s) and ASBA Accounts on the Designated Date, in this case being [●]
QIB Category/ QIB Portion	The portion of the Offer (including the Anchor Investor Portion) being not more than 50% of the Net Offer, consisting of [●] Equity Shares aggregating to ₹[●] million which shall be Allotted to QIBs (including Anchor Investors) on a proportionate basis, including the Anchor Investor Portion (in which allocation shall be on a discretionary basis, as determined by our Company and the Selling Shareholders in consultation with the BRLMs), subject to valid Bids being received at or above the Offer Price or Anchor Investor Offer Price (for Anchor Investors)
Qualified Institutional Buyers/ QIBs/ QIB Bidders	Qualified institutional buyers as defined under Regulation 2(1)(ss) of the SEBI ICDR Regulations
Red Herring Prospectus/ RHP	The red herring prospectus to be issued in accordance with Section 32 of the Companies Act, 2013 and the provisions of the SEBI ICDR Regulations, which will not have complete particulars of the price at which the Equity Shares will be offered and the size of the Offer including any addenda or corrigenda thereto  The Bid/Offer Opening Date shall be at least three Working Days after the filing of Red Herring Prospectus with the RoC. The Red Herring Prospectus will become the Prospectus upon filing with the RoC after the Pricing Date, including any addenda or corrigenda thereto
Refund Account(s)	The account(s) to be opened with the Refund Bank(s), from which refunds, if any, of the whole or part of the Bid Amount to the Anchor Investors shall be made
Refund Bank(s)	The bank(s) which are clearing members registered with SEBI under the SEBI BTI Regulations, with whom the Refund Account(s) will be opened, in this case being [●]
Registered Brokers	Stockbrokers registered under the Securities and Exchange Board of India (Stock Brokers) Regulations, 1992, as amended with the stock exchanges having nationwide terminals, other than the members of the Syndicate and eligible to procure Bids in terms

<b>Term</b>	<b>Description</b>
	of circular number CIR/CFD/14/2012 dated October 4, 2012, and the UPI Circulars, issued by SEBI
Registrar Agreement	The agreement dated January 17, 2022, among our Company, the Selling Shareholders and the Registrar to the Offer in relation to the responsibilities and obligations of the Registrar to the Offer pertaining to the Offer
Registrar to the Offer/Registrar	Link Intime India Private Limited
Retail Individual Investor(s)/ RII(s)	Individual Bidders, who have Bid for the Equity Shares for an amount not more than ₹200,000 in any of the bidding options in the Offer (including HUFs applying through their Karta and Eligible NRIs and does not include NRIs other than Eligible NRIs)
Retail Portion	The portion of the Offer being not less than 35% of the Net Offer consisting of [●] Equity Shares aggregating to ₹[●] million, which shall be available for allocation to Retail Individual Investors in accordance with the SEBI ICDR Regulations (subject to valid Bids being received at or above the Offer Price)
Revision Form	Form used by the Bidders to modify the quantity of the Equity Shares or the Bid Amount in any of their ASBA Form(s) or any previous Revision Form(s). QIB Bidders and Non-Institutional Investors are not allowed to withdraw or lower their Bids (in terms of quantity of Equity Shares or the Bid Amount) at any stage. RIIs and Eligible Employees Bidding in the Employee Reservation Portion can revise their Bids during the Bid/Offer Period and withdraw their Bids until Bid/Offer Closing Date
SCORES	Securities and Exchange Board of India Complaints Redress System
Self-Certified Syndicate Bank(s)/ SCSB(s)	(i) The banks registered with SEBI, offering services in relation to ASBA (other than through UPI Mechanism), a list of which is available on the website of SEBI at <a href="https://www.sebi.gov.in/sebiweb/other/OtherAction.do?doRecognisedFpi=yes&amp;intmId=34">https://www.sebi.gov.in/sebiweb/other/OtherAction.do?doRecognisedFpi=yes&amp;intmId=34</a> or <a href="https://www.sebi.gov.in/sebiweb/other/OtherAction.do?doRecognisedFpi=yes&amp;intmId=35">https://www.sebi.gov.in/sebiweb/other/OtherAction.do?doRecognisedFpi=yes&amp;intmId=35</a> , as applicable, or such other website as updated from time to time, and (ii) The banks registered with SEBI, enabled for UPI Mechanism, a list of which is available on the website of SEBI at <a href="https://www.sebi.gov.in/sebiweb/other/OtherAction.do?doRecognisedFpi=yes&amp;intmId=40">https://www.sebi.gov.in/sebiweb/other/OtherAction.do?doRecognisedFpi=yes&amp;intmId=40</a> or such other website as updated from time to time  Applications through UPI in the Offer can be made only through the SCSBs mobile applications (apps) whose name appears on the SEBI website. A list of SCSBs and mobile application, which, are live for applying in public issues using UPI mechanism is appearing in the “list of mobile applications for using UPI in public issues” displayed on the SEBI website. The said list shall be updated on the SEBI website
Share Escrow Agent	Escrow agent to be appointed pursuant to the Share Escrow Agreement, namely, [●]
Share Escrow Agreement	Agreement to be entered into amongst the Selling Shareholders, our Company and the Share Escrow Agent in connection with the transfer of Equity Shares under the Offer by the Selling Shareholders and credit of such Equity Shares to the demat account of the Allottees
Specified Locations	Bidding centres where the Syndicate shall accept ASBA Forms from Bidders, a list of which will be included in the Bid cum Application Form
Sponsor Bank	A Banker to the Offer registered with SEBI, which has been appointed by our Company to act as a conduit between the Stock Exchanges and NPCI in order to push the UPI Mandate Request and/or payment instructions of the RIIs using the UPI Mechanism and carry out other responsibilities, in terms of the UPI Circulars, in this case being [●]
Stock Exchanges	Collectively, BSE Limited and National Stock Exchange of India Limited.
Syndicate Agreement	Agreement to be entered into among our Company, the Selling Shareholders, the Registrar to the Offer, the BRLMs and the Syndicate Members in relation to collection of Bid cum Application Forms by Syndicate
Syndicate Members	Intermediaries (other than the BRLMs) registered with SEBI who are permitted to accept bids, applications and place order with respect to the Offer and carry out activities as an underwriter, namely, [●]
Systemically Important Non-Banking Financial Company/ NBFC-SI	Systemically important non-banking financial company as defined under Regulation 2(1)(iii) of the SEBI ICDR Regulations

<b>Term</b>	<b>Description</b>
Syndicate/members of the Syndicate	Together, the BRLMs and the Syndicate Members
Underwriters	[●]
Underwriting Agreement	The agreement among the Underwriters, our Company, the Selling Shareholders and the Registrar to the Offer to be entered into on or after the Pricing Date, but prior to filing of the Prospectus
UPI	Unified Payments Interface, which is an instant payment mechanism, developed by NPCI
UPI Circulars	The SEBI circular no. SEBI/HO/CFD/DIL2/CIR/P/2018/138 dated November 1, 2018, SEBI circular no. SEBI/HO/CFD/DIL2/CIR/P/2019/50 dated April 3, 2019, SEBI circular no. SEBI/HO/CFD/DIL2/CIR/P/2019/76 dated June 28, 2019, SEBI circular no. SEBI/HO/CFD/DIL2/CIR/P/2019/85 dated July 26, 2019, SEBI circular no. SEBI/HO/CFD/DCR2/CIR/P/2019/133 dated November 8, 2019, SEBI/HO/CFD/DIL2/CIR/P/2020/50 dated March 30, 2020, SEBI circular no. SEBI/HO/CFD/DIL2/CIR/P/2021/2480/1/M dated March 16, 2021, SEBI circular no. SEBI/HO/CFD/DIL1/CIR/P/2021/47 dated March 31, 2021, SEBI circular no. SEBI/HO/CFD/DIL2/P/CIR/2021/570 dated June 2, 2021 and any subsequent circulars or notifications issued by SEBI in this regard
UPI ID	ID created on Unified Payment Interface (UPI) for single-window mobile payment system developed by the NPCI
UPI Mandate Request	A request (intimating the Retail Individual Investor, by way of a notification on the UPI linked mobile application as disclosed by SCSBs on the website of SEBI and by way of an SMS directing the Retail Individual Investor to such UPI linked mobile application) to the Retail Individual Investor using the UPI Mechanism initiated by the Sponsor Bank to authorize blocking of funds equivalent to the Bid Amount in the relevant ASBA Account through the UPI linked mobile application, and the subsequent debit of funds in case of Allotment
UPI Mechanism	The Bidding mechanism that may be used by Retail Individual Investors to make Bids in the Offer in accordance with UPI Circulars
UPI PIN	Password to authenticate UPI transaction
Working Day	All days on which commercial banks in Mumbai, India are open for business, provided however, for the purpose of announcement of the Price Band and the Bid/Offer Period, "Working Day" shall mean all days, excluding all Saturdays, Sundays and public holidays on which commercial banks in Mumbai, India are open for business and the time period between the Bid/Offer Closing Date and listing of the Equity Shares on the Stock Exchanges, "Working Day" shall mean all trading days of the Stock Exchanges excluding Sundays and bank holidays in India in accordance with circulars issued by SEBI

#### Conventional and general terms and abbreviations

<b>Term</b>	<b>Description</b>
A/c	Account
AGM	Annual general meeting
Axis	Axis Capital Limited
BSE	BSE Limited
CAGR	Compounded Annual Growth Rate
Calendar Year or year/ CY	Unless the context otherwise requires, shall refer to the twelve-month period ending December 31
CCPS	Compulsorily Convertible Preferential Shares
CDSL	Central Depository Services (India) Limited
CIN	Corporate Identity Number
Companies Act, 1956	Companies Act, 1956, and the rules, regulations, notifications, modifications and clarifications notified thereunder, as the context requires
Companies Act, 2013/ Companies Act	Companies Act, 2013 and the rules, regulations, notifications, modifications and clarifications notified thereunder
Consolidated FDI Policy	The consolidated FDI Policy, effective from October 15, 2020, issued by the DPIIT, and any amendments or substitutions thereof, issued from time to time

<b>Term</b>	<b>Description</b>
COVID-19	The novel coronavirus disease, which is an infectious disease caused by a newly discovered coronavirus strain that was discovered in 2019 resulting in a public health emergency of international concern and a pandemic as declared by the World Health Organization on January 30, 2020 and pandemic on March 11, 2020
CRISIL	CRISIL Limited
CRISIL Report	The report titled “ <i>CRISIL Research - Industry Assessment of Automobile Dealership Industry in India released in Mumbai in December 2021</i> ” prepared, which has been exclusively commissioned and paid for by our Company specifically in connection with the Offer
CSR	Corporate social responsibility
Demat	Dematerialised
Depositories Act	Depositories Act, 1996 read with rules and regulations thereunder
Depository or Depositories	NSDL and CDSL
DIN	Director Identification Number
DPD	Days past due
DP ID	Depository Participant’s Identification Number
DP/ Depository Participant	A depository participant as defined under the Depositories Act
DPIIT	The Department for Promotion of Industry and Internal Trade, Ministry of Commerce and Industry, Government of India
EBITDA	Earnings before interest, taxes, depreciation, and amortisation expense
EGM	Extraordinary general meeting
EPS	Earnings per share
EUR/ €	Euro
FDI	Foreign direct investment
FEMA	Foreign Exchange Management Act, 1999, including the rules and regulations notified thereunder
FEMA Rules	Foreign Exchange Management (Non-debt Instruments) Rules, 2019
Finance Act	An Act passed every financial year to give effect to the financial proposals of the Central Government
Financial Year, Fiscal, Fiscal year, FY/ F.Y.	Period of twelve months ending on March 31 of that particular year, unless stated otherwise
FPI(s)	A foreign portfolio investor who has been registered pursuant to the SEBI FPI Regulations
Fraudulent Borrower	Fraudulent borrower as defined under Regulation 2(1)(III) of the SEBI ICDR Regulations
FVCI	Foreign Venture Capital Investors (as defined under the Securities and Exchange Board of India (Foreign Venture Capital Investors) Regulations, 2000) registered with SEBI
FVTPL	Fair value through profit and loss
GDP	Gross domestic product
Government of India/ GoI/ Central Government	Government of India
GST	Goods and services tax
HUF	Hindu undivided family
I.T. Act	The Income-tax Act, 1961
ICAI	The Institute of Chartered Accountants of India
IFRS	International Financial Reporting Standards
Ind AS/ Indian Accounting Standards	The Indian Accounting Standards notified under Section 133 of the Companies Act and read with the Ind AS Rules
Ind AS Rules	Companies (Indian Accounting Standards) Rules, 2015
Indian GAAP	Generally Accepted Accounting Principles in India notified under Section 133 of the Companies Act, 2013 and read together with paragraph 7 of the Companies (Accounts) Rules, 2014 and Companies (Accounting Standards) Amendment Rules, 2016
IPO	Initial public offer
IRDAI	Insurance Regulatory Development Authority of India
ISEC	ICICI Securities Limited
IT	Information technology
MCA	Ministry of Corporate Affairs, Government of India.

Term	Description
MCLR	Marginal cost of fund-based lending rate
Mn/ mn	Million
N.A. or NA	Not applicable
NACH	National Automated Clearing House
NAV	Net asset value
NEFT	National electronic fund transfer
Non-Resident	A person resident outside India, as defined under FEMA
No.	Number
NPCI	National payments corporation of India
NRE Account	Non-resident external account established in accordance with the Foreign Exchange Management (Deposit) Regulations, 2016
NRI/ Non-Resident Indian	A person resident outside India who is a citizen of India as defined under the Foreign Exchange Management (Deposit) Regulations, 2016 or is an 'Overseas Citizen of India' cardholder within the meaning of section 7(A) of the Citizenship Act, 1955
NRO Account	Non-resident ordinary account established in accordance with the Foreign Exchange Management (Deposit) Regulations, 2016
NSDL	National Securities Depository Limited
NSE	National Stock Exchange of India Limited
OCB/ Overseas Corporate Body	A company, partnership, society or other corporate body owned directly or indirectly to the extent of at least 60% by NRIs including overseas trusts in which not less than 60% of the beneficial interest is irrevocably held by NRIs directly or indirectly and which was in existence on October 3, 2003 and immediately before such date had taken benefits under the general permission granted to OCBs under the FEMA and which was de-recognised through Foreign Exchange Management (Withdrawal of General Permission to Overseas Corporate Bodies (OCBs)) Regulations, 2003. OCBs are not allowed to invest in the Offer
P/E Ratio	Price/earnings ratio
PAN	Permanent account number allotted under the I.T. Act
PAT	Profit After Tax
RBI	Reserve Bank of India
Regulation S	Regulation S under the U.S. Securities Act
RoNW	Return on net worth
Rupees /Rs. /₹/ INR	Indian Rupees
RTGS	Real time gross settlement
SCRA	Securities Contracts (Regulation) Act, 1956
SCRR	Securities Contracts (Regulation) Rules, 1957
SEBI	Securities and Exchange Board of India constituted under the SEBI Act
SEBI Act	Securities and Exchange Board of India Act, 1992
SEBI AIF Regulations	Securities and Exchange Board of India (Alternative Investment Funds) Regulations, 2012
SEBI BTI Regulations	Securities and Exchange Board of India (Bankers to an Issue) Regulations, 1994
SEBI FPI Regulations	Securities and Exchange Board of India (Foreign Portfolio Investors) Regulations, 2019
SEBI FVCI Regulations	Securities and Exchange Board of India (Foreign Venture Capital Investors) Regulations, 2000
SEBI ICDR Regulations	Securities and Exchange Board of India (Issue of Capital and Disclosure Requirements) Regulations, 2018, as amended
SEBI Listing Regulations	Securities and Exchange Board of India (Listing Obligations and Disclosure Requirements) Regulations, 2015
SEBI Merchant Bankers Regulations	Securities and Exchange Board of India (Merchant Bankers) Regulations, 1992
SEBI SBEB Regulations	Securities and Exchange Board of India (Share Based Employees Benefits and Sweat Equity) Regulations, 2021
SEBI Takeover Regulations	Securities and Exchange Board of India (Substantial Acquisition of Shares and Takeovers) Regulations, 2011
SEBI VCF Regulations	The <i>erstwhile</i> Securities and Exchange Board of India (Venture Capital Fund) Regulations, 1996 as repealed pursuant to SEBI AIF Regulations



<b>Term</b>	<b>Description</b>
State Government	Government of a state of India
US GAAP	Generally Accepted Accounting Principles in the United States of America
USA/ U.S. / US / United States	The United States of America, its territories and possessions, any State of the United States, and the District of Columbia
USD / US\$	United States Dollars
U.S. Securities Act	The United States Securities Act of 1933, as amended
VAT	Value added tax
VCFs	Venture capital funds as defined in, and registered with SEBI under, the SEBI VCF Regulations
Wilful Defaulter	Wilful defaulter as defined under Regulation 2(1)(III) of the SEBI ICDR Regulations

#### **Technical and Industry Related Terms**

<b>Term</b>	<b>Description</b>
Ashok Leyland	Ashok Leyland Limited
CRM	Customer relationship management
CV	Commercial vehicles
ERP	Enterprise resource planning
FCA India	FCA India Automobiles Limited
Honda	Honda Cars India Limited
LCV	Light commercial vehicles
M&HCV	Medium and heavy commercial vehicles
Mass market segment	SIAM classification of micro, mini and lower compact and vans segments
Mercedes-Benz	Mercedes-Benz India Private Limited
OEM/ OEMs	Original equipment manufacturer(s)
Pitstop	Chatpay Commerce Private Limited
Premium segment	SIAM classification of upper compact, super compact, executive, premium and utility vehicles
PV	Passenger vehicles
Renault	Renault India Private Limited
SC	Service centers
SCV	Small commercial vehicles
SH	Sales outlets
Sheerdrive	Sheerdrive Private Limited
Stellantis	Stellantis ICT India
SUV	Sport utility vehicles
UV	Utility vehicles
Volkswagen	Volkswagen Passenger Cars, a division of SKODA Auto, Volkswagen India Private Limited

## **CERTAIN CONVENTIONS, USE OF FINANCIAL INFORMATION, INDUSTRY AND MARKET DATA AND CURRENCY OF PRESENTATION**

### **Certain Conventions**

All references in this Draft Red Herring Prospectus to “India” are to the Republic of India and its territories and possessions and all references herein to the “Government”, “Indian Government”, “GoI”, “Central Government” or the “State Government” are to the Government of India, central or state, as applicable.

All references herein to the “US”, the “U.S.”, the “U.S.A.”, or the “United States” are to the United States of America and its territories and possessions.

Unless indicated otherwise, all references to page numbers in this Draft Red Herring Prospectus are to page numbers of this Draft Red Herring Prospectus.

### **Financial Data**

Unless stated otherwise or the context requires otherwise, the financial information and financial ratios in this Draft Red Herring Prospectus are derived from our Restated Consolidated Financial Information. For further information, see “*Financial Information*” on page 202.

Our Company’s financial year commences on April 1 of the immediately preceding calendar year and ends on March 31 of that particular calendar year and accordingly, all references to a particular financial year or fiscal are to the 12-month period commencing on April 1 of the immediately preceding calendar year and ending on March 31 of that particular calendar year. Unless the context requires otherwise, all references to a year in this Draft Red Herring Prospectus are to a calendar year and references to a Fiscal/Fiscal Year are to the year ended on March 31, of that calendar year. Certain other financial information pertaining to our Group Companies are derived from their respective audited financial statements.

Our Restated Consolidated Financial Information, which comprises of the restated consolidated statement of assets and liabilities as at September 30, 2021, March 31, 2021, March 31, 2020 and March 31, 2019, and the restated consolidated statements of profit and loss (including other comprehensive income), restated consolidated statement of cash flows, restated consolidated statements of changes in equity and the restated consolidated summary statements of significant accounting policies and other explanatory notes and notes to restated consolidated financial information for the six months ended September 30, 2021 and for the years ended March 31, 2021, March 31, 2020 and March 31, 2019, derived from the audited special purpose consolidated interim financial statements of the Company and its Subsidiaries, as at and for the six months ended September 30, 2021 prepared in accordance with the recognition and measurement principles of Ind AS 34-Interim Financial Reporting and the audited Ind AS consolidated financial statements of our Company and its Subsidiaries as at and for the years ended March 31, 2021, March 31, 2020 and March 31, 2019 prepared in accordance with Ind AS specified under Section 133 of the Companies Act 2013, read with the Companies (Indian Accounting Standards) Rules, 2015, as amended and restated in accordance with the requirements of Section 26 of Part 1 of Chapter III of the Companies Act, 2013, the SEBI ICDR Regulations and the Guidance Note on Reports in Company Prospectuses (Revised 2019) issued by the ICAI read with the general directions dated October 28, 2021 received from Securities and Exchange Board of India (SEBI) by the Company through Lead Managers (the “*SEBI Communication*”), as applicable. Financial information for the six months ended September 30, 2021, is not indicative of full year results and is not comparable with the annual financial statements presented in this Draft Red Herring Prospectus.

There are significant differences between Ind AS, Indian GAAP, US GAAP and IFRS. Our Company does not provide reconciliation of its financial information to IFRS or US GAAP. Our Company has not attempted to explain those differences or quantify their impact on the financial data included in this Draft Red Herring Prospectus and it is urged that you consult your own advisors regarding such differences and their impact on our Company’s financial data. For details in connection with risks involving differences between Ind AS, U.S. GAAP and IFRS see “*Risk Factors – Significant differences exist between Ind AS and other accounting principles, such as US GAAP and IFRS, which may be material to investors’ assessments of our financial condition.*” on page 53. The degree to which the financial information included in this Draft Red Herring Prospectus will provide meaningful information is entirely dependent on the reader’s level of familiarity with Indian accounting policies and practices, the Companies Act, 2013 and the SEBI ICDR Regulations. Any reliance by persons not familiar with Indian accounting policies and practices on the financial disclosures presented in this Draft Red Herring Prospectus should accordingly be limited. Further, any figures sourced from third-party industry sources may be rounded off to other than two decimal points to conform to their respective sources.

Unless the context otherwise indicates, any percentage amounts as set forth in “*Risk Factors*”, “*Our Business*” and “*Management’s Discussion and Analysis of Financial Position and Results of Operations*” on pages 28, 133 and 272, respectively, and elsewhere in this Draft Red Herring Prospectus have been calculated and amounts derived from our Restated Consolidated Financial Information or non-GAAP financial measures as described below.

In this Draft Red Herring Prospectus, any discrepancies in any table between the total and the sums of the amounts listed are due to rounding off. All figures in decimals have been rounded off to the second decimal and all percentage figures have been rounded off to two decimal places. In certain instances, (i) the sum or percentage change of such numbers may not conform exactly to the total figure given; and (ii) the sum of the numbers in a column or row in certain tables may not conform exactly to the total figure given for that column or row.

### **Non-GAAP Financial Measures**

Certain non-GAAP and certain other statistical information relating to our operations and financial measures relating to our financial performance such as, EBITDA, EBITDA margin, net profit ratio, Return on Equity Ratio, return on capital employed, net debt / EBITDA ratio, net worth, RoNW and NAV per Equity Share have been included in this Draft Red Herring Prospectus. We compute and disclose such non-GAAP financial measures relating to our financial performance as we consider such information to be useful measures of our business and financial performance. These non-GAAP financial measures and other statistical and other information relating to operations and financial performance are a supplemental measure of our performance and liquidity that is not required by, or presented in accordance with, Ind AS, Indian GAAP, IFRS or US GAAP. Further, these non-GAAP Measures and other statistical and other information relating to operations and financial performance should not be considered in isolation or construed as an alternative to cash flows, profit/ (loss) for the years/ period or any other measure of financial performance or as an indicator of our operating performance, liquidity, profitability or cash flows generated by operating, investing or financing activities derived in accordance with Ind AS, Indian GAAP, IFRS or US GAAP. In addition, these non-GAAP Measures and other statistical and other information relating to operations and financial performance, are not standardised terms and may not be computed on the basis of any standard methodology that is applicable across the industry and therefore, may not be comparable to financial measures of similar nomenclature that may be computed and presented by other companies and are not measures of operating performance or liquidity defined by Ind AS and may not be comparable to similarly titled measures presented by other companies. Further, they may have limited utility as a comparative measure. Although such non-GAAP financial measures are not a measure of performance calculated in accordance with applicable accounting standards, our Company’s management believes that they are useful to an investor in evaluating us as they are widely used measures to evaluate a company’s operating performance.

### **Industry and Market Data**

Unless stated otherwise, industry and market data used in this Draft Red Herring Prospectus has been obtained or derived from the report titled “*CRISIL Research - Industry Assessment of Automobile Dealership Industry in India released in Mumbai in December 2021*” prepared by CRISIL (“**CRISIL Report**”) and publicly available information as well as other industry publications and sources. The CRISIL Report and its excerpts as used for this Draft Red Herring Prospectus, has been exclusively commissioned and paid for by our Company specifically in connection with the Offer. The CRISIL Report is available on our website at <https://www.grouplandmark.in/corporate-document/>.

The CRISIL Report is subject to the following disclaimer:

*“CRISIL Research, a division of CRISIL Limited (CRISIL) has taken due care and caution in preparing this report (Report) based on the Information obtained by CRISIL from sources which it considers reliable (Data). This Report is not a recommendation to invest / disinvest in any entity covered in the Report and no part of this Report should be construed as an expert advice or investment advice or any form of investment banking within the meaning of any law or regulation. CRISIL especially states that it has no liability whatsoever to the subscribers / users / transmitters/ distributors of this Report. Without limiting the generality of the foregoing, nothing in the Report is to be construed as CRISIL providing or intending to provide any services in jurisdictions where CRISIL does not have the necessary permission and/or registration to carry out its business activities in this regard. Landmark Cars Limited will be responsible for ensuring compliances and consequences of non-compliances for use of the Report or part thereof outside India. CRISIL Research operates independently of, and does not have access to information obtained by CRISIL Ratings Limited / CRISIL Risk and Infrastructure Solutions Ltd (CRIS), which may, in their regular operations, obtain information of a confidential nature. The views expressed in this Report are that of CRISIL Research and not of CRISIL Ratings Limited / CRIS. No part of this Report may be published/reproduced in any form without CRISIL’s prior written approval.”*

The data used in industry publications may have been reclassified by us for the purposes of presentation and may also not be comparable. Given the scope and extent of the CRISIL Report, disclosures are limited to certain excerpts and the CRISIL Report has not been reproduced in its entirety in this Draft Red Herring Prospectus. There are no material parts, data or information (which may be relevant for the proposed Offer), that have been left out or changed in any manner. Industry sources and publications may also base their information on estimates and assumptions that may prove to be incorrect. The extent to which the industry and market data presented in this Draft Red Herring Prospectus is meaningful and depends upon the reader's familiarity with, and understanding of, the methodologies used in compiling such information. There are no standard data gathering methodology in the industry in which our Company conducts business and methodologies and assumptions may vary widely among different market and industry sources. Such information involves risks, uncertainties and numerous assumptions and is subject to change based on various factors, including those discussed in "Risk Factors – This Draft Red Herring Prospectus contains information from industry sources including the industry report commissioned from CRISIL Research and paid for by the Company. Investors are advised not to place undue reliance on such information" on page 46.

### Currency and Units of Presentation

All references to "Rupees" or "INR" or "₹" or "Rs." are to Indian Rupees, the official currency of the Republic of India.

All references to "U.S.\$", "U.S. Dollar", "USD" or "U.S. Dollars" are to United States Dollars, the official currency of the United States of America.

In this Draft Red Herring Prospectus, our Company has presented certain numerical information. All figures have been expressed in million. In this regard, please note: (a) One million is equal to 1,000,000/10 lakhs; and (b) 10 million is equal to 10,000,000/100 lakhs/ one crore. However, where any figures that may have been sourced from third party industry sources are expressed in denominations other than millions in their respective sources, such figures appear in this Draft Red Herring Prospectus expressed in such denominations as provided in such respective sources.

### Time

All references to time in this Draft Red Herring Prospectus are to Indian Standard Time. Unless indicated otherwise, all references to a year in this Draft Red Herring Prospectus are to a calendar year.

### Exchange Rates

This Draft Red Herring Prospectus may contain conversions of certain other currency amounts into Indian Rupees that have been presented solely to comply with the requirements of the SEBI ICDR Regulations. These conversions should not be construed as a representation that such currency amounts could have been, or can be converted into Indian Rupees, at any particular rate, or at all.

The exchange rates for the periods indicated are provided below.

Currency	Exchange rate as at <span style="float: right;">(in ₹)</span>			
	September 30, 2021	March 31, 2021	March 31, 2020	March 31, 2019*
1 USD	74.26	73.50	75.39	69.17

Source: [www.fbil.org.in](http://www.fbil.org.in).

\*In the event that March 31 of any of the respective years is a public holiday, the previous calendar day not being a public holiday has been considered.

Note: Exchange rate is rounded off to two decimal places.

## FORWARD-LOOKING STATEMENTS

This Draft Red Herring Prospectus contains certain statements which are not statements of historical fact and may be described as “forward-looking statements”. These forward-looking statements include statements which can generally be identified by words or phrases such as “aim”, “anticipate”, “are likely”, “believe”, “continue”, “can”, “could”, “expect”, “estimate”, “intend”, “may”, “likely”, “objective”, “plan”, “propose”, “will continue”, “seek to”, “will achieve”, “will likely”, “will pursue” or other words or phrases of similar import. Similarly, statements that describe the strategies, objectives, plans or goals of our Company are also forward-looking statements. All statements regarding our expected financial conditions, results of operations, business plans and prospects are forward-looking statements. These forward-looking statements include statements as to our business strategy, plans, revenue and profitability (including, without limitation, any financial or operating projections or forecasts) and other matters discussed in this Draft Red Herring Prospectus that are not historical facts. However, these are not the exclusive means of identifying forward-looking statements.

These forward-looking statements are based on our current plans, estimates and expectations and actual results may differ materially from those suggested by such forward-looking statements. All forward-looking statements are subject to risks, uncertainties and assumptions about us that could cause actual results to differ materially from those contemplated by the relevant forward-looking statement. This may be due to risks or uncertainties associated with our expectations with respect to, but not limited to, regulatory changes pertaining to the industries we cater to and our ability to respond to them, our ability to successfully implement our strategies, our growth and expansion, technological changes, our exposure to market risks, general economic and political conditions in India and globally, which have an impact on our business activities or investments, the monetary and fiscal policies of India, inflation, deflation, unanticipated turbulence in interest rates, foreign exchange rates, equity prices or other rates or prices, the performance of the financial markets in India and globally, changes in domestic laws, regulations and taxes, changes in competition in our industry and incidence of any natural calamities and/or acts of violence.

Certain important factors that could cause actual results to differ materially from our expectations include, but are not limited to, the following:

- Our reliance on our OEMs for new vehicles sourcing, and for the maintenance of the value, perception, marketing and overall competitive of their vehicle brands;
- If one or more of our OEMs chooses not to renew, to terminate or to require adverse material modifications to our dealership or agency agreements;
- Our inability to expand our business of buying and selling pre-owned vehicles and establishing;
- Our inability to successfully implement some or all our business strategies in a timely manner or at all;
- Any general economic slowdown or other adverse economic events in India or globally that may adversely affect consumer confidence and the demand for premium and luxury automobiles;
- Uncertainty of the impact of the COVID-19 pandemic;
- Our reliance on the states of Gujarat and Maharashtra for a significant portion of our sales;
- Our inability to maintain and enhance the value and perception of our “Landmark” brand;
- Our inability to successfully anticipate changes in consumer preferences and tastes in new or updated automobile models or vehicle types; and
- Non-compliance with and changes in, safety, health, environmental and labour laws and other applicable regulations.

For a further discussion of factors that could cause our actual results to differ from the expectations, see “*Risk Factors*”, “*Our Business*” and “*Management’s Discussion and Analysis of Financial Position and Results of Operations*” on pages 28, 133 and 272, respectively. By their nature, certain market risk disclosures are estimates and could be materially different from what actually occurs in the future. As a result, actual future gains or losses could be materially different from those that have been estimated. Forward-looking statements reflect our current views as of the date of this Draft Red Herring Prospectus and are not a guarantee of future performance. These statements are based on our management’s belief and assumptions, which in turn are based on currently available information. Although we believe that the assumptions on which such statements are based are reasonable, any such assumptions as well as statements based on them could prove to be inaccurate.

We cannot assure investors that the expectations reflected in these forward-looking statements will prove to be correct. Given these uncertainties, investors are cautioned not to place undue reliance on such forward-looking statements and not to regard such statements as a guarantee of future performance.

Neither our Company, the Directors, the Selling Shareholders, nor the Book Running Lead Managers, or the Syndicate or any of their respective affiliates have any obligation to update or otherwise revise any statements reflecting

circumstances arising after the date hereof or to reflect the occurrence of underlying events, even if the underlying assumptions do not come to fruition. In accordance with the SEBI ICDR Regulations, our Company and each of the Selling Shareholders in respect of statements/ disclosures made by them in this Draft Red Herring Prospectus with respect to themselves and the Equity Shares offered by them in the Offer shall, severally and not jointly, ensure that investors in India are informed of material developments from the date of the Red Herring Prospectus until the date of Allotment. Only statements and undertakings which are specifically confirmed or undertaken by a Selling Shareholder, as the case may be, in this Draft Red Herring Prospectus shall be deemed to be statements and undertakings made by such Selling Shareholder.

## SUMMARY OF THIS OFFER DOCUMENT

This section is a general summary of the terms of Offer, certain disclosures included in this Draft Red Herring Prospectus and are not exhaustive, nor does it purport to contain a summary of all the disclosures in this Draft Red Herring Prospectus or all details relevant to prospective investors. This summary should be read in conjunction with, and is qualified in its entirety by, the more detailed information appearing elsewhere in this Draft Red Herring Prospectus, including the sections titled “*The Offer*”, “*Risk Factors*”, “*Industry Overview*”, “*Our Business*”, “*Capital Structure*”, “*Restated Consolidated Financial Information*”, “*Objects of the Offer*” “*Our Promoter and Promoter Group*”, “*Management’s Discussion and Analysis of Financial Position and Results of Operations*” and “*Outstanding Litigation and Other Material Developments*” on pages 60, 28, 105, 133, 76, 202, 88, 196, 272 and 314, respectively.

### Primary business of our Company

We are a leading premium automotive retail business in India with dealerships for Mercedes-Benz, Honda, Jeep, Volkswagen and Renault. We also cater to the commercial vehicle retail business in India. We have a presence across the automotive retail value chain, including sales of new vehicles, after-sales service (including sales of spare parts, lubricants and accessories), sales of pre-owned passenger vehicles and facilitation of sales of third-party financial and insurance products. We have a network of 112\* outlets in 8 Indian states, comprised of 61 sales showrooms and outlets and 51\* after-sales service and spares outlets, as of September 30, 2021.

\*includes acquisition of 4 after sales and spares outlets pursuant to acquisition of Shaman Wheels Private Limited with effect from October 1, 2021.

### Summary of industry in which the Company operates

In the last 5 years, the premium vehicle segment in India has grown at a healthy 8% CAGR, expanding its contribution from 38% in Fiscal 2016 to 56% in Fiscal 2021. For a passenger vehicle dealer, revenue from new vehicle sales forms a dominant 65-75% share of total revenue. Income from the service segment is another major source of revenue for the dealer, and CRISIL Research expects the share of revenue from services to expand going forward due to the technical expertise needed to repair the latest advanced vehicles that only organised dealerships can provide. (Source: CRISIL Report, December 2021).

### Promoter

As on the date of this Draft Red Herring Prospectus, Sanjay Karsandas Thakker is the Promoter of our Company. For further details, see “*Our Promoter and Promoter Group*” at page 196.

### The Offer

Offer	Up to [●] Equity Shares, aggregating up to ₹ 7,620.00 million
<i>Of which</i>	
Fresh Issue <sup>1</sup> ^	Up to [●] Equity Shares, aggregating up to ₹ 1,500.00 million
Offer for Sale <sup>2</sup>	Up to [●] Equity Shares, aggregating up to ₹ 6,120.00 million (comprising up to [●] Equity Shares aggregating up to ₹ 4,000.00 million by TPG Growth, up to [●] Equity Shares aggregating up to ₹ 620.00 million by Sanjay Karsandas Thakker HUF, up to [●] Equity Shares aggregating up to ₹ 1,200.00 million by Aastha Limited and up to [●] Equity Shares aggregating up to ₹ 300.00 million by Garima Misra)
Employee Reservation Portion <sup>3</sup>	Up to [●] Equity Shares aggregating up to ₹ [●] million
Net Offer	Up to [●] Equity Shares aggregating up to ₹ [●] million

<sup>^</sup> Our Company and the Selling Shareholders, in consultation with the BRLMs, may consider the Pre-IPO Placement aggregating up to ₹ 300.00 million. If the Pre-IPO Placement is completed, the size of the Fresh Issue will be reduced to the extent of such Pre-IPO Placement, subject to the Offer constituting at least [●]% of the post-Offer paid up Equity Share capital of our Company.

<sup>1</sup> Our Board has authorised the Offer, pursuant to their resolution dated January 11, 2022. Our Shareholders have authorised the Fresh Issue pursuant to their resolution dated January 11, 2022.

<sup>2</sup> The Equity Shares being offered by the Selling Shareholders are eligible for being offered for sale pursuant to the Offer for Sale in terms of the SEBI ICDR Regulations. Each of the Selling Shareholders has specifically confirmed that its respective portion of the Offered Shares are eligible to be offered for sale in the Offer in accordance with the SEBI ICDR Regulations. For details, see “*Other Regulatory and Statutory Disclosures – Authority for the Offer*” on page 331.

<sup>3</sup> In the event of under-subscription in the Employee Reservation Portion, the unsubscribed portion will be available for allocation and Allotment, proportionately to all Eligible Employees who have Bid in excess of ₹ 200,000, subject to the maximum value of Allotment made to such Eligible Employee not exceeding ₹ 500,000. The unsubscribed portion, if any, in the Employee Reservation Portion (after allocation of up to ₹ 500,000, as applicable), shall be added to the Net Offer. For further details, see “Offer Structure” on page 347.

The Offer and the Net Offer shall constitute [●]% and [●]% of the post-Offer paid up Equity Share capital of our Company, respectively.

For further details, see “The Offer” and “Offer Structure” on pages 60 and 347, respectively.

### Objects of the Offer

The Net Proceeds are proposed to be utilised towards the following Objects:

Objects	Amount <sup>^</sup>
Repayment/pre-payment, in full or in part, of certain borrowings availed by our Company (on a consolidated basis)	1,200.00
General corporate purposes*	[●]
<b>Net Proceeds</b>	<b>[●]</b>

(in ₹ million)

\* To be determined upon finalisation of the Offer Price and updated in the Prospectus prior to filing with the RoC. The aggregate amount utilised for general corporate purposes shall not exceed 25% of the gross proceeds from the Fresh Issue.

<sup>^</sup> Includes the proceeds, if any, received pursuant to the Pre-IPO Placement. Upon allotment of Equity Shares issued pursuant to the Pre-IPO Placement, we may utilise the proceeds from such Pre-IPO Placement towards the Objects of the Offer.

For further details, see “Objects of the Offer” on page 89.

### Aggregate pre-Offer shareholding of our Promoter, Promoter Group and the Selling Shareholders

(a) The aggregate pre-Offer shareholding of our Promoter and Promoter Group as a percentage of the pre-Offer paid-up Equity Share capital of our Company is set out below:

Sr. No.	Name of the Shareholder	No. of Equity Shares	Percentage of the pre-Offer paid up Equity Share capital
<b>Promoter</b>			
1.	Sanjay Karsandas Thakker (jointly with Ami Sanjay Thakker)	15,154,768	41.38
<b>Promoter Group</b>			
2.	Ami Sanjay Thakker (jointly with Sanjay Karsandas Thakker)	5,584,848	15.25
3.	Aryaman Sanjay Thakker (jointly with Sanjay Karsandas Thakker)	565,040	1.54
4.	Sanjay Karsandas Thakker HUF	757,722	2.07
<b>Total</b>		<b>22,062,378</b>	<b>60.24</b>

(b) The aggregate pre-Offer shareholding of the Selling Shareholders as a percentage of the pre-Offer paid-up Equity Share capital of our Company is set out below:

Sr. No.	Name of the Selling Shareholder	No. of Equity Shares held	Percentage of the pre-Offer paid up Equity Share capital
1.	TPG Growth	10,879,194	29.70
2.	Sanjay Karsandas Thakker HUF	757,722	2.07
3.	Aastha Limited	1,462,448	3.99
4.	Garima Misra	1,012,012	2.76
<b>Total</b>		<b>14,111,376</b>	<b>38.52</b>

For further details, see “Capital Structure” at page 76.

### Summary of Restated Consolidated Financial Information

The following information has been derived from our Restated Consolidated Financial Information:



(in ₹ million, except per share data)

Particulars	As at and for the period/Fiscal ended			
	September 30, 2021	March 31, 2021	March 31, 2020	March 31, 2019
Equity Share capital	183.13	183.13	183.13	183.13
Net worth	2,085.49	1,817.75	1,691.25	1,879.64
Revenue from operations	14,128.42	19,561.04	22,186.14	28,265.18
Profit/(Loss) for the period / year	279.47	111.48	(289.39)	(244.28)
Earnings/(Loss) per Equity Share*				
- Basic	7.58	3.09	(7.84)	(7.01)
- Diluted	7.40	3.05	(7.84)	(7.00)
NAV per Equity Share	56.93	49.62	46.17	52.14
Borrowings	4,088.43	3,274.41	3,579.08	4,787.76

Notes:

- Basic earnings per share = Net profit attributable to equity shareholders/ Weighted average number of shares outstanding during the year/period after sub-division of equity shares.
- Diluted earnings per share = Net profit attributable to equity shareholders/ Weighted average number of diluted potential shares outstanding during the year/period after sub-division of equity shares.
- NAV (₹) = Net worth/ Weighted average number of shares outstanding during the year/period after sub-division of equity shares.
- Net worth means the aggregate value of the paid-up share capital and other equity.
- Borrowings means the aggregate of short-term borrowings, long-term borrowings and vehicle floor plan payable.

\* Pursuant to a resolution of our Shareholders on November 10, 2021, each equity share of ₹10 each of our Company was sub-divided into two Equity Shares of ₹5 each. Accordingly, our issued and paid-up Equity Share capital of 18,312,810 equity shares of face value of ₹ 10 each was sub-divided into 36,625,620 Equity Shares.

For further details, see “Restated Consolidated Financial Information” beginning on page 202.

### Qualifications of the Statutory Auditors which have not been given effect to in the Restated Consolidated Financial Information

There are no qualifications by the Statutory Auditors in their audit reports on the Ind AS consolidated financial statements as at and for the six months ended September 30, 2021 and as at and for the years ended March 31, 2021, March 31, 2020 and March 31, 2019, which have not been given effect to in the Restated Consolidated Financial Information.

### Summary of outstanding litigation

A summary of outstanding litigation proceedings involving our Company, Subsidiaries, Directors and Promoter in accordance with the SEBI ICDR Regulations and the Materiality Policy as on the date of this Draft Red Herring Prospectus, is provided below.

Name of entity	Criminal proceedings	Tax proceedings	Statutory or regulatory proceedings	Disciplinary actions by the SEBI or Stock Exchanges against our Promoter	Material civil litigation	Aggregate* amount involved (₹ in million)
<b>Company</b>						
By the Company	4	-	-	-	-	0.41
Against the Company	-	8	-	-	8	207.23
<b>Directors</b>						
By our Directors	-	-	-	-	-	-
Against the Directors	1	-	-	-	-	53.10
<b>Promoter</b>						
By Promoter	-	-	-	-	-	-
Against Promoter	1	-	-	-	-	53.10
<b>Subsidiaries</b>						
By Subsidiaries	3	-	-	-	1	10.09
Against Subsidiaries	4	20	1	-	14	291.16

\*To the extent quantifiable.

As on the date of this Draft Red Herring Prospectus, there are no pending litigation involving any of the Group Companies which may have a material impact on the Company.

## Risk factors

Specific attention of Investors is invited to the section “Risk Factors” on page 28. Investors are advised to read the risk factors carefully before taking an investment decision in the Offer.

## Summary of contingent liabilities of our Company

A summary of contingent liabilities as at September 30, 2021, is set forth below:

(₹ in million)

Particulars	As at September 30, 2021
<b>Contingent Liabilities</b>	
Matters with GST authorities*	21.96
Matters with service tax authorities**	217.24
Matters with Income Tax authorities	1.30
Matters with VAT authorities***	6.04
Matters with local authorities	21.45
Corporate guarantees outstanding	1,875.33

\* During the year ended March 31, 2021, the group has received show-cause notice of ₹ 19.75 million for the period July 2017 to March 2018 for the difference in GST input tax credit between GSTR 3B and GSTR 2A. The group is still awaiting adjudication from the authorities.

The group has also received order from GST authorities for claiming excess transitional VAT credit of ₹ 0.34 million for the period July 2017 to March 2018. The Group has received notice from GST authorities of ₹ 1.87 million for the financial year 2019-20 for the carrying invalid e-way bill during the transportation. The Group filed Writ Petition before Honourable Gujarat High court based on Bank Guarantee of ₹ 1.10 million.

\*\* During the financial year 2019-20, the group had received show-cause notice from Central Goods and Service Tax authorities amounting to ₹217.20 million pertains to service tax supposed to be levied on the discounts / incentives received from original equipment manufacturers. The group is still awaiting adjudication from the authorities.

During the financial year 2019-20, the Group had received show-cause notice from Central Goods and Service Tax authorities pertaining to additional service tax liability for the difference in service tax returns and 26 AS issued by the Income tax department amounting to ₹ 0.04 million for the financial year 2014-15. Subsequently, the Group has accepted the service tax liability along with interest and penalty and paid the same.

\*\*\* During the previous year, Mumbai VAT department had raised demand pertaining to non-submission of C forms and F forms and input tax credit mismatch for the year 2016-17 amounting to ₹ 1.63 million. Further, during the financial year 2016-17, the Company had received show-cause notice from VAT authorities amounting to ₹ 2.91 million pertaining to VAT supposed to be levied on handling charges considering to be part of sales consideration. The Company is still awaiting adjudication from the authorities. For the period April 2017 to June 2017, the Company had received show-cause notice from Madhya Pradesh VAT authorities amounting to ₹ 1.50 million pertaining to difference in VAT liability in F form. The Company has paid 10% of the demand under dispute amounting to ₹ 0.15 million.

For further details, see “Restated Consolidated Financial Information- Notes to Restated Consolidated Financial Information – Note 37 - Contingent Liabilities and Commitments” at page 245.

## Summary of Related Party Transactions

A summary of related party transactions entered into by our Company with related parties and as reported in the Restated Consolidated Financial Information is set forth below.

(₹ in million)

Sr. No.	Related party transactions	For the six months period ended September 30, 2021	For the year ended		
			March 31, 2021	March 31, 2020	March 31, 2019
1	<b>Advertisement Expenses</b>				
	Adorn Studio LLP	-	-	0.07	0.58
	Wild Dreams Media and Communications Private Limited	10.73	13.42	30.73	42.28
2	<b>Purchase of spares and services</b>				
	Landmark Commercial Vehicles Private Limited (Up to September 30, 2018)	-	-	-	0.02
	Landmark Pre-Owned Cars Private Limited	-	18.83	0.11	0.17
3	<b>Interest Paid</b>				
	Sanjay Karsandas Thakker	2.00	10.20	6.41	5.99
	Aryaman Sanjay Thakker	0.11	1.12	0.74	0.81

Sr. No.	Related party transactions	For the six months period ended September 30, 2021	For the year ended		
			March 31, 2021	March 31, 2020	March 31, 2019
	Sanjay Karsandas Thakker HUF	0.51	2.28	0.32	1.96
	Aparajita Sanjay Thakker	0.12	0.89	0.40	0.34
	Urvi Ashwin Mody	0.32	0.25	0.25	-
	Smita Ashwin Mody	0.12	0.59	0.08	-
	Landmark Commercial Vehicles Private Limited (Up to September 30, 2018)	-	-	-	0.97
	Ami Sanjay Thakker	1.76	8.75	3.08	5.05
4	<b>Reimbursement of expenses</b>				
	Paras Somani	0.09	0.14	0.40	0.55
	Sanjay Karsandas Thakker	-	-	0.02	0.11
	Aryaman Sanjay Thakker	-	-	0.36	0.03
	Udayan Karsandas Thakker	0.06	0.09	0.09	-
	Urvi Ashwin Mody	-	-	0.06	0.04
5	<b>Remuneration</b>				
	Sanjay Karsandas Thakker	5.30	7.49	10.93	9.91
	Aparajita Sanjay Thakker	-	1.63	0.83	-
	Ami Sanjay Thakker	1.56	2.33	5.90	8.79
	Aryaman Sanjay Thakker	1.66	2.00	1.26	1.98
	Paras Somani	5.14	8.16	8.94	14.47
	Surendra Kumar Agarwal	2.90	5.78	5.80	5.11
	Urvi Ashwin Mody	2.16	4.02	4.53	4.53
6	<b>Rent expense</b>				
	Udayan Karsandas Thakker	0.46	0.92	0.77	-
	Sanjay Karsandas Thakker HUF	0.17	0.34	0.29	-
	Udayan Karsandas Thakker HUF	0.24	0.48	0.40	-
7	<b>Sale of spares and services</b>				
	Paras Somani	-	-	0.02	0.21
	Aryaman Sanjay Thakker	-	-	-	0.00*
	Landmark Pre-Owned Cars Private Limited	-	2.62	8.96	11.16
8	<b>Loans Taken</b>				
	Sanjay Karsandas Thakker	160.50	234.40	58.40	44.08
	Sanjay Karsandas Thakker HUF	19.10	14.00	7.00	0.40
	Smita Ashwin Mody	3.00	2.50	6.50	-
	Ami Sanjay Thakker	132.20	157.10	26.00	24.10
	Aryaman Sanjay Thakker	8.50	5.00	1.50	9.20
	Urvi Ashwin Mody	1.50	7.50	13.50	-
	Aparajita Sanjay Thakker	7.00	7.70	3.50	5.20
9	<b>Loans Repaid</b>				
	Sanjay Karsandas Thakker	172.06	140.20	128.43	40.20
	Ami Sanjay Thakker	135.95	97.60	83.60	23.20
	Aryaman Sanjay Thakker	5.00	9.50	1.90	6.30
	Smita Ashwin Mody	-	8.50	-	-
	Urvi Ashwin Mody	-	13.50	-	-
	Sanjay Karsandas Thakker HUF	13.30	20.25	8.74	0.20
	Aparajita Sanjay Thakker	7.70	9.20	0.30	0.90
10	<b>Purchase of Property, Plant and Equipment</b>				
	Landmark Pre-owned Cars Private Limited	-	-	-	0.79
11	<b>Deposit Given (rent)</b>				
	Sanjay Karsandas Thakker HUF	-	-	0.13	-
	Udayan Karsandas Thakker HUF	0.05	-	0.52	-
12	<b>Commission Income</b>				
	Landmark Pre-owned Cars Private Limited	-	2.15	-	-
	Krish Somani	-	0.21	-	-
	Landmark Insurance Brokers Private Limited	11.41	22.57	12.52	0.05
	Falguni Somani	-	0.60	-	-

Sr. No.	Related party transactions	For the six months period ended September 30, 2021	For the year ended		
			March 31, 2021	March 31, 2020	March 31, 2019
13	<b>Shared based expense</b>				
	Paras Somani	-	-	0.38	16.97
	Urvi Ashwin Mody	-	-	0.05	2.26
	Surendra Kumar Agarwal	0.22	0.00*	-	-
14	<b>Other Support Service Income</b>				
	Landmark Pre-Owned Cars Private Limited	-	-	4.10	20.16
	Landmark Commercial Vehicles Private Limited (Up to September 30, 2018)	-	-	-	5.10

\*0.00 denotes figures are below the rounding off norms adopted by the Group.

For details of the related party transactions and as reported in the Restated Consolidated Financial Information, see “Restated Consolidated Financial Information – Notes to Restated Consolidated Financial Information - Note 44 – Related Party Transactions” on page 251.

### Financing arrangements

There have been no financing arrangements whereby our Promoter, members of the Promoter Group or our Directors and their relatives (as defined in the Companies Act, 2013) have financed the purchase by any other person of securities of our Company (other than in the normal course of business of the financing entity) during the period of six months immediately preceding the date of this Draft Red Herring Prospectus.

### Weighted average price at which the Equity Shares were acquired by our Promoter and the Selling Shareholders

Pursuant to a resolution of our Shareholders on November 10, 2021, each equity share of ₹10 each of our Company was sub-divided into two Equity Shares of ₹5 each. Accordingly, our issued and paid-up Equity Share capital of 18,312,810 equity shares of face value of ₹ 10 each was sub-divided into 36,625,620 Equity Shares.

Our Promoter and the Selling Shareholders have not acquired any Equity Shares in the one year preceding the date of this Draft Red Herring Prospectus.

### Average cost of acquisition of Equity Shares by our Promoter and the Selling Shareholders

The average cost of acquisition of Equity Shares by our Promoter and the Selling Shareholders, as at the date of this Draft Red Herring Prospectus, is:

(in ₹)		
Name of Promoter / Selling Shareholder	Number of Equity Shares held	Average cost of acquisition per Equity Share*#
<b>Promoter</b>		
Sanjay Karsandas Thakker (jointly with Ami Sanjay Thakker)	15,154,768	3.50
<b>Selling Shareholders</b>		
TPG Growth	10,879,194	137.42
Sanjay Karsandas Thakker HUF	757,722	3.30
Aastha Limited	1,462,448	9.36
Garima Misra	1,012,012	3.30

\* As adjusted for the sub-division of the face value of the equity shares of our Company from ₹10 each to ₹5 each.

#As certified by Manubhai & Shah LLP, Chartered Accountants, by way of their certificate dated January 18, 2022.

### Details of pre-IPO placement

Our Company and the Selling Shareholders, in consultation with the BRLMs, may consider a further issue of Equity Shares, through a preferential issue or any other method as may be permitted under the applicable laws to any person(s), aggregating up to ₹ 300.00 million, at its discretion, prior to filing of the Red Herring Prospectus with the RoC (“**Pre-IPO Placement**”). If the Pre-IPO Placement is completed, the size of the Fresh Issue will be reduced to the extent of such Pre-IPO Placement, subject to the Offer constituting at least [●]% of the post-Offer paid up Equity Share capital of our Company.

**Issue of equity shares for consideration other than cash in the last one year**

Our Company has not issued any Equity Shares for consideration other than cash in the one year preceding the date of this Draft Red Herring Prospectus.

**Split or consolidation of equity shares in the last one year**

Except as disclosed below, our Company has not undertaken split or consolidation of its equity shares in the one year preceding the date of this Draft Red Herring Prospectus:

<b>Date of Shareholder's resolution</b>	<b>Particulars</b>
November 10, 2021	Our Company sub-divided the face value of its equity shares from ₹10 each into Equity Shares of ₹5 each. Accordingly, our issued and paid-up Equity Share capital of 18,312,810 equity shares of face value of ₹ 10 each were sub-divided into 36,625,620 Equity Shares.

For details, see “*Capital Structure – Notes to the Capital Structure- Equity share capital history of our Company*” on page 76.

## SECTION II - RISK FACTORS

*An investment in equity shares involves a high degree of risk. You should carefully consider all the information in this Draft Red Herring Prospectus, including the risks and uncertainties described below before making an investment in the Equity Shares. We have described the risks and uncertainties that we consider material, but these risks and uncertainties may not be the only risks relevant to us, the Equity Shares, or the industry in which we currently operate or propose to operate. Unless specified or quantified in the relevant risk factor below, we are not in a position to quantify the financial or other implication of any of the risks mentioned in this section. If any or a combination of the following risks actually occur, or if any of the risks that are currently not known or deemed to be not relevant or material now actually occur or become material in the future, our business, cash flows, prospects, financial condition and results of operations could suffer, the trading price of the Equity Shares could decline, and you may lose all or part of your investment. For more details on our business and operations, see “Our Business,” “Industry Overview,” “Key Regulations and Policies in India” and “Management’s Discussion and Analysis of Financial Position and Results of Operations” beginning on pages 133, 105, 161 and 272, respectively, as well as other financial information included elsewhere in this Draft Red Herring Prospectus.*

*In making an investment decision, you must rely on your own examination of us and the terms of the Offer, including the merits and risks involved, and you should consult your tax, financial and legal advisors about the particular consequences of investing in the Offer. Prospective investors should pay particular attention to the fact that our Company is incorporated under the laws of India and is subject to a legal and regulatory environment which may differ in certain respects from that of other countries.*

*This Draft Red Herring Prospectus also contains forward-looking statements that involve risks, assumptions, estimates and uncertainties. Our actual results could differ materially from those anticipated in these forward-looking statements as a result of certain factors, including but not limited to the considerations described below. For details, see “Forward-Looking Statements” beginning on page 19.*

*Unless otherwise indicated, industry and market data used in this section has been derived from the CRISIL Report, prepared and released by CRISIL and commissioned and paid for by us in connection with the Offer. Unless otherwise indicated, all financial, operational, industry and other related information derived from the CRISIL Report and included herein with respect to any particular year, refers to such information for the relevant year.*

*Our fiscal year ends on March 31 of each year, and references to a particular fiscal period are to the twelve months ended March 31 of that year. References to a six months period or “Half Year” are to the six months ended September 30 of a particular fiscal year. Unless otherwise specified or as the context requires, financial information included in this section for Half Year Fiscal 2022, Fiscal 2021, Fiscal 2020 and Fiscal 2019 is derived from our Restated Consolidated Financial Information.*

*Unless otherwise stated, in this section references to “we”, “us”, and “our” are to Landmark Cars Limited and its subsidiaries; and references to the “the Company”, “our Company” and/or “Issuer” are to Landmark Cars Limited.*

### INTERNAL RISK FACTORS

#### Risks Relating to our Business

- 1. We are subject to the significant influence of, and restrictions imposed by OEMs pursuant to the terms of our dealership or agency agreements that may adversely impact our business, results of operations, financial condition and prospects, including our ability to expand into new territories and acquire additional dealerships.***

We operate our dealerships pursuant to dealership agreements with Honda, Volkswagen, Jeep, Renault and Ashok Leyland and an agency agreement with Mercedes-Benz. Pursuant to the terms of these agreements, each of the OEMs are able to exert influence over the day-to-day operations of our dealerships with the respective OEM. For instance, the OEMs may unilaterally discontinue associations with vendors where we might have entered into long term contracts and made advance payments to such vendors for services. The OEMs are also typically entitled from time to time to prescribe guidelines and/or the minimum requirements and specifications that each of our sales outlets and after-sales service and spares outlets are required to adhere to which may require significant capital expenditure from time to time. For instance, we are subject to numerous operational requirements and restrictions relating to inventory levels, working capital levels, the sales process, signage, marketing and branding, showroom and service facilities, personnel, changes in management, and monthly financial reporting, and periodic inspections and audits, among other things. We are also required to adhere to certain service and customer satisfaction levels prescribed by the OEMs in operating our dealerships and our failure to do so may lead to the termination of the relevant dealership

agreement. The terms and conditions of our dealership or agency arrangements and the OEMs' interests and objectives may, in certain circumstances, conflict with our interests and objectives. For instance, under our Mercedes-Benz agency agreement, we are precluded from acquiring additional dealerships with other OEMs unless we obtain prior consent from Mercedes-Benz.

Further, the OEMs are also entitled to establish new dealerships in the same geographical area or relocate existing dealerships. The establishment of or relocation of dealerships in our markets (with our OEMs or otherwise) could have a material adverse effect on the business, results of operations and financial condition of our dealerships in the market in which the action is taken. Further, any reduction in margins or capping of service fees by the OEMs may impact our revenues and profitability. For further details, see “- *Margins earned from our services and repair vertical may be impacted by pricing guidelines set by our OEMs*” on page 34. The significant influence of and restrictions imposed by OEMs could impact our business, results of operations, financial condition and prospects.

**2. *Our success depends on the value, perception, marketing and overall competitiveness of our OEMs' vehicle brands in India and any damage to these brands or their failure to compete effectively in India could materially adversely affect our business, results of operations and financial condition.***

We operate our dealerships for our OEMs' brands: Mercedes-Benz, Honda, Volkswagen, Jeep, Renault and Ashok Leyland. Our success depends on the value, perception, marketing and overall competitiveness of our OEMs' brands in India and on our OEMs' ability to maintain and enhance brand value.

Indian consumers are exposed to a large variety of advertising and marketing efforts by automotive industry participants, including large expenditures on television, radio, print media, online and social media, billboards as well as at events and other promotions. Accordingly, our business is also dependent on customers' perception of our OEM's brands and these advertising and marketing campaigns of our OEMs and their competitors.

Our OEMs from time to time establish various marketing and sales incentive programs designed to increase consumer demand for their vehicles, particularly during Indian festivals or periods of excess supply and/or in a flat or declining new or pre-owned vehicle market. These programs impact our operations, particularly our sales of new vehicles. Since these programs are often not announced in advance, they can be difficult to plan for when budgeting for inventory. Furthermore, OEMs may modify or discontinue these marketing and incentive programs from time to time depending on various factors which could have a material adverse effect on business, results of operations and financial condition.

Our OEM's brands could be damaged by negative publicity or by claims or perceptions about the quality, reliability and safety of their vehicles, regardless of whether or not such claims or perceptions are true. Any untoward incidents such as litigation, product recalls, regulatory actions or negative publicity, whether isolated or recurring, can significantly reduce our OEM's brand value and consumer trust. In addition, competing automotive brands may be more successful at enhancing the value of their brands by successful marketing and advertising or by unmatched increases in marketing and advertising spend in India. For example, competing OEMs' brands may launch promotional activities, concepts, branding and advertising activities, which may increase their brand visibility which our OEMs' brands are unable to match. If our OEMs through their efforts fail to preserve the value of their brands, maintain their reputation, or attract consumers, our sales of vehicles at our dealerships could be adversely impacted thereby adversely affecting our business, results of operations and financial condition.

Further, some of the OEMs that compete with our OEMs' brands in the Indian market may have greater financial, research and technological resources, larger sales and marketing teams and more established reputations and local knowledge in India. In addition, competing OEMs' brands may also be in a better position to identify market trends, adapt to changes in industry, introduce innovative new models, introduce models better suited for the India market, offer more competitive prices or develop better reputations for product quality, reliability and safety. Any inability of our OEMs' brands to compete effectively in the Indian market, could materially adversely affect our business, results of operations and financial condition.

**3. *We may not be able to complete, or achieve the expected benefits from, current or future dealership acquisitions which could materially adversely affect our business, results of operations and financial condition.***

We have used acquisitions as a means of increasing the geographic reach of our dealerships and we may continue to make acquisitions to do so; and we also may use acquisitions to acquire new OEM partners and expand the reach of our service businesses in line with our strategy. For example, w.e.f. October 1, 2021, we acquired four service centres of Mercedes-Benz from a co-dealer, Shaman Wheels Private Limited in Mumbai and Navi Mumbai. If we do not successfully integrate the acquired dealerships, after-sales service businesses or companies, the anticipated operating

advantages, benefits to our brands and cost savings may not be realized.

Our ability to acquire existing dealerships or after-sales service businesses and integrating them into our business is dependent on a multitude of factors including our ability to identify suitable locations or suitable businesses to acquire in synergy with our existing dealerships, receipt of consent from the OEMs, and limitations on our capital resources, amongst others.

Under our dealership and agency agreements, acquisition of new dealerships requires the consent from the OEMs. In determining whether to approve an acquisition, our OEMs may consider many factors, including our financial condition, ownership structure, the number of dealerships currently operated by us and our performance in such dealerships, frequency of acquisitions, ownership of dealerships in adjoining markets, percentage of market share that may be controlled by our dealerships amongst other factors. Further, in determining whether to approve any proposal for us to partner with different brands of OEMs, our existing OEMs may evaluate factors such as competition, geographical considerations and financial performance, amongst others. If we identify suitable opportunities, obtaining consent of the OEMs may also take a considerable amount of time. We cannot assure you that the OEMs will approve future acquisitions or expansions in a timely manner or at all and/or will not impose additional conditions with respect to our existing arrangements.

In addition, the acquisition and integration of dealerships, service centers and companies involve a number of risks, including:

- Lack of proper implementation or remediation of controls, procedures and policies at the acquired dealership company;
- use of available cash, new borrowings or borrowings under existing credit facilities to consummate the acquisition may not yield targeted or desired benefits;
- lower than expected sales of the acquired dealership or company;
- problems in integration of the acquired company's accounting, human resources and other administrative systems, including management information, purchasing, accounting, finance, billing, payroll and benefits and regulatory compliance;
- incurring additional facility renovation costs or other expenses required by the OEM;
- inability to identify all the risks, liabilities and challenges in relation to the proposed acquisition;
- demands placed on our management related to the increase in our overall business size after an acquisition;
- diversion of management's attention from existing operations to the integration of acquired companies; integration of acquired companies existing systems into our systems;
- difficulties in the assimilation and retention of employees;
- difficulties in the maintenance of relationships with OEMs and other key relationships to an acquired company;
- incurring significantly higher capital expenditures and operating expenses, which could substantially limit our operating or financial flexibility;
- entering new and unfamiliar markets;
- difficulties in coordinating the sales and marketing functions of the acquired business with our existing business;
- ongoing obligations under agreements related to the acquisition;
- infringement claims, violation of laws, commercial disputes, tax liabilities and other known and unknown liabilities; or
- inheritance of claims or liabilities, as a result of strategic acquisitions, including claims from OEM, customers, or other third parties and potential adverse effects on our operating results.



Accordingly, we cannot assure you that our current or future acquisitions will prove value accretive to us and to our shareholders. If any of the risks described above (or a combination thereof) or any other incidental risks should materialize, our business, results of operations, financial condition and prospects may be adversely affected. We may not be able to maintain the levels of operating efficiency that acquired companies achieved separately. Successful integration of acquired operations will depend upon our ability to manage those operations and to eliminate redundant and excess costs. We may not be able to achieve the cost savings and other benefits that we would hope to achieve from acquisitions. Failure in effectively acquiring and integrating acquired businesses may result in diminution, loss or write-off of our investments in such businesses, which could materially adversely affect our business, results of operations and financial condition.

4. ***The decision by any of our OEMs not to renew, to terminate or to require adverse material modifications to any of our dealership or agency agreements entered into with them could have a material and adverse effect on our business, results of operations and financial condition. In particular, Mercedes-Benz has required that we restructure our dealership arrangement with them to an agency model. We can make no assurances that our business, results of operations and financial condition will not be adversely affected by this change.***

As of the date of this Draft Red Herring Prospectus, we operated under passenger vehicle dealership agreements with Honda, Volkswagen, Jeep and Renault, a commercial vehicle dealership of Ashok Leyland and an agency agreement with Mercedes-Benz. Further, we also have dealership and distribution agreements for spare parts distribution with various OEMs. Pursuant to the dealership agreements entered into with the OEMs, we have been authorized as a dealer of such OEMs, generally on a non-exclusive and non-transferable basis, in identified geographies. These dealership agreements have been entered into for fixed periods of time ranging between 12 months to just over three years and any renewal is subject to the mutual consent of both parties. There can be no assurance that we will be able to successfully obtain a renewal of such dealership agreements on similar or more favorable terms, as and when necessary, in a timely manner or at all. Additionally, there can be no assurance that the OEMs will not impose any additional onerous restrictions or conditions in the dealership agreements. Further, in accordance with the terms of such dealership agreements, the respective OEMs are entitled to unilaterally terminate such dealership agreements without cause by providing written notice within 90 days and in certain instances, forthwith, without notice, upon breach of terms of the agreement or upon the occurrence of certain events, including, inter alia, bankruptcy, failure to honour repayment terms under our loan agreements, conduct of our business not being satisfactory to the relevant OEMs, amongst others.

Although we have been successful in obtaining renewals for our dealership agreements in the past, there can be no assurance that we may be able to continue to do so in the future. Further, our dealership and agency agreements may be terminated by either party without assigning reason. In the event that one or more OEMs are unwilling to renew such agreements or impose terms and conditions at the time of renewal that are less favorable to us than the existing terms and conditions, or in the event one or more OEMs exercise their right to unilaterally terminate their dealership agreements, whether upon the occurrence of any of the events described hereinabove or otherwise, or in the event that there are any disputes initiated between us and the OEMs, we may be unable to identify and/or receive consent for alternative dealership arrangements, which may materially and adversely impact our ability to carry on our business operations and also materially and adversely impact our business, results of operations and financial condition.

With effect from October 1, 2021, our dealership agreement with Mercedes-Benz materially changed and converted to an agency model whereby all car sales will be made directly to customers by Mercedes-Benz. Under this agency model, we no longer purchase cars from Mercedes-Benz and re-sell them to the customer. Hence, we will have no inventory of Mercedes-Benz cars except for demo cars and customers will place orders through us directly to Mercedes-Benz on which we will earn a commission. This change will have the effect of reducing our sale of cars revenue from Mercedes-Benz cars as we will only be showing revenue from commission instead of booking the full price of vehicles sold as revenue. Although we do not expect that this change to an agency model will adversely impact the profitability of our Mercedes-Benz dealerships, we do not have any experience relating to this agency model in India, and we can make no assurances that our business, results of operations and financial condition will not be adversely affected.

5. ***Our investments in building our pre-owned vehicle business and establishing a new electric passenger dealership with BYD may not be successful and may be loss-making.***

As part of our strategy, we are making investments to expand our business of buying and selling pre-owned vehicles manufactured for the various OEMs. The pre-owned vehicle market in India is highly competitive, and we face established competition from other OEM dealerships, standalone pre-owned vehicle dealerships and marketplace places, vehicle auctions and online vehicle market places. In order to maintain a competitive position, we must

continue to invest in developing our brand, our inventory and our marketing and advertising of our pre-owned vehicle business. This is particularly true in the current environment where online sales and distribution channels have been successful in penetrating an otherwise mature market. In some cases, our investments will be in-house expansion and, in others, they may take the form of an acquisition or investments. Notwithstanding our investments, we cannot guarantee that our efforts to build our pre-owned vehicle business will be successful. Even if we are successful in executing our strategy of expanding our pre-owned vehicles business, our pre-owned vehicle business may be less profitable than what we have experienced historically in our new passenger vehicle businesses, may be loss-making, may consume substantial financial resources, expose us to litigation or product liability claims and/or may divert management's attention from our existing operations, all of which could materially adversely affect our business, results of operations and financial condition.

In addition, WCPL has recently entered into a letter of intent with the automaker BYD India Private Limited ("BYD") for our Company to become their dealer in the National Capital Region (Delhi) and Mumbai in respect of BYD's electric passenger vehicles. The electric vehicle market in India is not as well developed as in other countries and there is uncertainty as to whether there is sufficient demand for electric vehicles to make a standalone electric passenger vehicle dealership a success. Further, demand for electric vehicles in the National Capital Region (Delhi) and Mumbai may be dampened if consumers perceive there are insufficient charging stations. There is also uncertainty as to whether electric vehicles may reduce parts and service revenues as compared to petrol / diesel consuming vehicles. In addition, although we have significant experience in dealerships for traditional petrol / diesel consuming vehicles, we lack experience in selling electric cars as a main business line. Accordingly, we cannot guarantee that our investments to establish these new BYD dealerships will be successful. Further our electric vehicle business, may be less profitable than what we have experienced historically in our other new passenger vehicle businesses, may be loss-making, may consume substantial financial resources, expose us to litigation or product liability claims and/or may divert management's attention from our existing operations, all of which could materially adversely affect our business, results of operations and financial condition.

**6. *The automotive retail industry is sensitive to changing economic conditions and various other factors which could have a material adverse effect on our business, results of operations and financial condition.***

We are a leading premium and luxury car retail business in India with dealerships for Mercedes-Benz, Honda, Jeep, Volkswagen and Renault. We believe that there are a number of factors that affect the sales of new and pre-owned vehicles in India, which are difficult to predict, including but not limited to, the state of the economy, fuel prices, credit availability, interest rates, consumer preferences, the level of personal discretionary spending, unemployment rates, vehicle production levels and capacity, auto emission and fuel economy standards, the rate of inflation, currency exchange rates, tariffs, incentives, intensity of industry competition, product quality, the rise of ride hailing, ride-sharing and car rental platforms, improvement in public transport infrastructure, technological innovations and restrictions under environmental laws.

Any tightening of the credit markets and credit conditions in India may decrease the availability of automotive loans and adversely impact our new and pre-owned vehicle sales and margins. In particular, if banks and NBFCs apply higher credit standards in respect of loans provided by them generally or in respect of vehicle loans or if there is a decline in the overall availability of credit in the lending market, the ability of consumers to purchase vehicles could be adversely impacted, which could have a material adverse effect on our business, results of operations and financial condition.

Further, volatile fuel prices may also affect consumer preferences in relation to purchase of vehicles. Rising fuel prices may make consumers less likely to purchase larger, more expensive vehicles, such as sports utility vehicles or luxury automobiles, and more likely to purchase smaller, less expensive and more fuel-efficient vehicles. Conversely, lower fuel prices could have the opposite effect. Volatility in fuel prices can cause rapid changes in consumer preferences which may be difficult to accommodate in terms of inventory management. Increases in fuel prices in the future could have a material adverse effect on our business, results of operations and financial condition.

The imposition of new tariffs, duties or any increase in prices for vehicles and vehicle components imported into India can adversely impact demand for such vehicles. For instance, fully built vehicles or spare parts that are being imported are prone to customs duty variation relating to input cost, which would lead to increase in cost of the vehicle, leading to an adverse impact on the demand of the car. Our vehicle sales, service and spares businesses could also be adversely affected by changes in the automotive industry driven by new technologies, including autonomous and electric vehicles, and accident avoidance technology. If new vehicle production exceeds the new vehicle industry selling rate, our new vehicle gross profit per vehicle retailed could be adversely impacted by excess supply and any resulting changes in incentive, marketing, and other programs of OEMs. For further information, see below "*Our success depends on the value, perception, marketing and overall competitiveness of our OEM's vehicle*

*brands in India and any damage to these brands or their failure to compete effectively in India could materially adversely affect our business, results of operations and financial condition.” on page 29.*

**7. *The COVID-19 pandemic had a material adverse effect on our business, results of operations and financial condition and the continuing impact of the COVID-19 pandemic is uncertain and still evolving, and could continue to adversely affect our business, results of operations and financial condition.***

In late 2019, COVID-19 began spreading globally. In March 2020, the World Health Organization declared COVID-19 as a pandemic, and numerous countries, including India, declared national emergencies in response to the COVID-19 pandemic. The COVID-19 pandemic resulted in quarantines, travel restrictions, limitations on social or public gatherings, and the temporary closure of business venues and facilities across the world, including India. The second wave of COVID-19 infections impacted India in April, May and June 2021. The second wave resulted in significant strain on the health infrastructure in the country resulting in several states announcing lockdown measures. On account of the second wave and a possibility of the third wave of the COVID-19 pandemic including on account of new variants of the COVID-19 virus such as Omicron, many countries along with India, may impose lockdowns and restrictions on travel, closing financial markets and/or restricting trading, and limiting the operations of non-essential businesses. While the vaccines have been made available to the masses, the effectiveness of available vaccines against various mutations of the COVID-19 virus is still uncertain. The scope, duration and frequency of such measures and the adverse effects of COVID-19 remain uncertain. The COVID-19 pandemic has also resulted in economic challenges driven by labor shortage, logistics disruptions and reduced demand. As a result, many industries have been exposed to disruptions in carrying out business operations, resulting in loss of business and reduction in cash flows, which has created stress in different sectors of the economy. Any downturn in the macroeconomic environment in India could also adversely affect our business, results of operations and financial condition. See “*Restated Consolidated Financial Information-Note 41*” on page 246.

Our business, results of operations and financial condition were materially and adversely affected due to the COVID-19 pandemic, and these adverse effects included (but were not limited to) the following:

- During the national lockdown, we experienced a complete suspension of activities at substantially all of our sales outlets and after-sales service and spares centers for extended periods of time, the length of which depended on the location.
- With the partial and gradual easing of the lockdown, we experienced overall low consumer demand in the automotive markets, and consequently reduced footfalls at all of our outlets during the first and second quarter of Fiscal 2021. We experienced improved business conditions and improved financial results in the third and fourth quarters of Fiscal 2021. In the first and second quarters of Fiscal 2021, our consolidated revenues declined by 79.07% and 14.89%, respectively, as compared to first and second quarters of FY 2020. Improved business conditions in the third and fourth quarter of Fiscal 2021, enabled us to show an increase of 0.94% and 52.96%, respectively, in the third and fourth quarters of Fiscal 2021 as compared to third and fourth quarters of Fiscal 2020.
- Due to second wave, in the first quarter of Fiscal 2022, we again experienced low consumer demand and reduced footfall at all of our outlets but not as pronounced as the decline in the first quarter of Fiscal 2021. Our consolidated revenue in the first quarter of Fiscal 2022 increased by 376.68% as compared to the first quarter of Fiscal 2021 but declined by 21.13% from the fourth quarter of Fiscal 2021.
- As the impact of the second wave lessened, we experienced a strong second quarter of Fiscal 2022, and our consolidated revenues increased by 92.32% as compared to the second quarter of Fiscal 2021 and increased by 63.98% from the first quarter of Fiscal 2022.
- Our after-sales service and spare parts revenue also declined in the first and second quarters of Fiscal 2021 but returned to previous levels in the third and fourth quarters. Our after-sales service and spare parts revenue also declined during the second wave in April 2021 and May 2021 but again returned to previous levels by July 2021.
- Order fulfilment by our OEMs have been impacted from time to time due to the COVID-19 pandemic including delays in ordered vehicles and spare parts reaching our outlets and delays in new model launches due to COVID-19 related production and supply-chain issues. In addition, our inventory levels for certain models of vehicles and certain spare parts have been impacted, and continue to be impacted, by COVID-19 related production and supply-chain issues resulting in lower inventory and shortages in some cases.
- We have incurred, and may continue to incur, additional costs in order to provide for the safety of our employees

and the continuity of our operations, including increased frequency of deep cleaning and sanitation, additional safety training and processes, enhanced hygiene practices and materials, flexible and remote working where possible, and allowing for greater social distancing for our employees who must work on-site.

- Our workforce and third-party service providers, including key personnel, have been unable to work effectively from time to time (especially during the lockdowns and second wave), and may in the future be unable to work effectively, because of illness, government actions, or other restrictions in connection with the pandemic.

The extent to which the COVID-19 pandemic, and the related global economic impact, affect our business, results of operations and financial condition will depend on future developments that are highly uncertain and cannot be predicted, including the spread, scope and duration of the COVID-19 pandemic and any recovery period, the effectiveness of further steps taken by the GoI and the RBI to mitigate the economic impact in response to the pandemic, the effects on our customers, counterparties, employees and third-party service providers, and the time it takes for economic activities to return to pre-pandemic levels. As of the date of this Draft Red Herring Prospectus, there is significant uncertainty relating to the severity of long-term adverse impact of the ongoing COVID-19 pandemic on the domestic and global economy, domestic and global financial markets and the Indian automotive industry, and we are unable to accurately predict the long-term impact of the COVID-19 pandemic on our dealership businesses. To the extent that the COVID-19 pandemic adversely affects our business and operations, it may also have the effect of heightening many of the other risks described in this section.

**8. *Margins earned from our services and repair vertical may be impacted by pricing guidelines set by our OEMs.***

Our services and repair offerings at each of our dealerships comprise of warranty work, customer paid work, running repair and collision repair services. We provide after-sales services and repairs through our 51\* after-sales service and spares outlets, as of September 30, 2021. Pursuant to the terms of our dealership agreements, our OEMs are entitled to determine the maximum prices we may charge for certain types of repairs and services undertaken at our authorized service centers. The OEMs are entitled to change the prices, or the discounts offered thereon, without prior notice and without incurring any liability towards us. Margins earned from our services and repairs vertical may be impacted by the ability of our vehicle manufacturers to periodically revise rates to be charged by our dealerships for the services and repair work done by us, to keep the total cost low for the customers. For instance, one of our OEMs fixes the maximum per hour labor charges for services and repair work undertaken by us which varies from city to city, while such caps are not applicable to collision repair services undertaken by us, we cannot assure you that such caps will not be introduced in future for collision repair services or that such caps will not be further revised to our detriment. Further, we are restricted from undertaking and selling services which are not approved by our OEMs. Given the volume of vehicles serviced by us, any capping of services fees or restrictions on scope of service offerings may significantly affect our business, results of operations and financial condition.

\*includes acquisition of 4 after sales service and spares outlets pursuant to acquisition of Shaman Wheels Private Limited w.e.f. October 1, 2021.

**9. *Our inability to successfully implement some or all of our business strategies in a timely manner or at all could have an adverse effect on our business.***

As part of our strategy aimed towards business growth and improvement of market position, we intend to implement several business strategies, which include:

- Continue expansion focusing on high growth segments and brands;
- Expand our after-sales service and spare parts business;
- Build our pre-owned passenger vehicle business leveraging our experience, technology and network;
- Continue to invest in technology and digitalizing sales and service channels; and
- Continue strategic acquisitions to expand geographic reach in premium and luxury brands.

Our strategies may not succeed due to various factors, including our failure to expand our existing dealerships as per the changing market preferences and trends, our failure to execute agreements with our OEMs necessary to expand our existing businesses or enter new dealerships, our inability to identify acquisition targets to expand the reach of our businesses, our failure to effectively market our inventory of vehicles and spare parts for sale or our after-sales services or foresee challenges with respect to our business initiatives, our failure to enter into new businesses successfully, our failure to sufficiently upgrade our infrastructure, equipment and technology as required to cater to the requirement of changing demand and market preferences, our failure to maintain highest quality and efficiency

in our operations and processes or to ensure scaling up of our operations to correspond with our strategy and customer demand, changes in policy or regulation, our inability to respond to regular competition, and other operational and management difficulties. Any failure on our part to implement our strategies due to many reasons as attributed aforesaid could be detrimental to our long-term business outlook and our growth prospects and may materially adversely affect our business, results of operations and financial condition. For further details of our strategies, see “*Our Business – Our Strategies*” on page 139.

**10. *We have reported a loss in Fiscals 2020 and 2019 and may incur additional losses in the future.***

We reported a consolidated loss after tax of ₹289.39 million and ₹244.28 million in Fiscals 2020 and 2019, respectively. We may incur losses after tax in the future. Our failure to generate profits may adversely affect the market price of our Equity Shares, restrict our ability to pay dividends and impair our ability to raise capital and expand our business. For further details, see “*Management’s Discussion and Analysis of Financial Position and Results of Operations*” beginning on page 272.

**11. *Increasing competition among automotive dealerships through online and offline marketing and competition from the unauthorized service centers may have an adverse impact on our business, results of operations and financial condition.***

Automobile retailing is a highly competitive business. Our competitors include private and public companies, some of whom may be larger with access to greater financial and marketing resources than us. Our competitors sell the same or similar makes of new and pre-owned vehicles that we offer in our markets at competitive prices.

Most of our dealership agreements do not grant us the exclusive right to sell vehicles manufactured by the OEMs within a given geographic area. Accordingly, our revenues or profitability could be materially adversely affected if any of the OEMs award dealerships to others in the same markets where we operate or if existing dealerships increase their market share in our markets. In addition, our OEMs could in certain cases set up their own dealerships in the markets in which we operate. Further, our revenues may also be impacted on account of expansion of dealerships of competing brands of vehicles in the markets in which we operate.

Moreover, we face competition from the unorganized sector, comprising unauthorized service centers, which may be able to provide servicing and maintenance services at lower prices. Consumers’ opting for such unauthorized service centers in place of our authorized service centers could have an adverse impact on business, results of operations and financial condition.

Further, the internet has become a significant part of the sales process in our industry. Customers are using the internet to compare pricing for vehicles and related finance and insurance services, which may further reduce margins for new and pre-owned vehicles and profits for related finance and insurance services. Our competitors may align themselves with services offered on the internet or invest in the development of their own internet capabilities. Apart from the existing competitors, we also face competition from online portal dealers and other new age disruptive models. Further, our OEMs may seek to directly retail their vehicles through online platforms, thus decreasing their reliance on us, which could materially adversely affect our business, results of operations and financial condition. We cannot assure that we will be able to match the online presence that is being offered by our competitors or maintain creativity in our existing online presence.

In addition, we may also face increasingly significant competition as we strive to gain market share through acquisitions or otherwise. Our operating margins may decline over time as we expand into markets where we do not have a leading position.

**12. *Changes to the automotive industry and consumer views on car ownership could have a material adverse effect on our business, results of operations and financial condition.***

The automotive industry is expected to experience rapid changes in the future, including increases in ride-sharing/hailing services, advances in electric vehicle production and driverless technology. Ride hailing and ride-sharing services provide consumers with varied mobility options reducing dependence on privately owned vehicles. The overall impact of these options on the automotive industry is uncertain and may influence levels of new vehicle sales. Further, OEMs continue to invest in research and development of all-electric vehicles, which generally require less maintenance than traditional passenger and commercial vehicles. While WCPL is taking steps to enter the electric vehicle segment by signing a letter of intent to establish dealerships for the electric car OEM, BYD, the effects of electric vehicles on the automotive industry are uncertain and may include reduced parts and service revenues. Technological advances are also facilitating the development of driverless vehicles. The eventual timing of availability of driverless vehicles is uncertain due to regulatory requirements, technological hurdles, and uncertain

consumer acceptance of these technologies. The effect of driverless vehicles on the automotive industry is uncertain and could include changes in the level of new and pre-owned vehicle sales and the price of new vehicles, any of which could materially and adversely affect our business, results of operations and financial condition. Further changes in emissions standards required by consumers or regulations could impact sales.

**13. *A large portion of our business operations are concentrated in the states of Gujarat and Maharashtra, and any adverse developments in these states could have an adverse effect on our business, results of operations and financial condition.***

In the six months ended September 30, 2021, Fiscal 2021, Fiscal 2020 and Fiscal 2019, 46.74%, 52.41%, 52.25% and 56.90% of our vehicle sales and 44.28%, 50.77%, 47.87% and 49.26% of our total consolidated revenue was derived from dealership operations in Gujarat and 27.55%, 24.61%, 23.60% and 18.27% of our vehicle sales and 30.65%, 23.47%, 25.12% and 21.43% of our total consolidated revenue was derived from dealership operations in Maharashtra. The concentration of all of our operations in Gujarat and Maharashtra heightens our exposure to adverse developments related to regulation, as well as economic, demographic and other changes in these states. In the event of a slowdown in the economic activity in these states, or any other developments including natural disasters, political unrest, disruption or sustained economic downturn, we may experience an adverse impact on our business, results of operations and financial condition, which are largely dependent on the performance and other prevailing conditions affecting the economies of these states. Furthermore, the states of Gujarat and Maharashtra have experienced social and civil unrest in the past and such tensions could lead to political or economic instability and a possible adverse effect on our business, results of operations and financial condition. There can be no assurance that such situations will not recur or be more intense than in the past.

**14. *Our business operations are dependent upon the success and continued financial stability of the OEMs with which we have dealership agreements.***

The success of our dealerships is dependent on the success and continued financial stability of our OEMs, namely Mercedes-Benz, Honda, Volkswagen, Jeep, Renault and Ashok Leyland. We rely exclusively on our OEMs for our new passenger, commercial vehicle and spare parts inventory. Our ability to sell new passenger and commercial vehicles of a particular OEM is dependent on such OEM's ability to produce and allocate an attractive and desirable product mix to our showrooms, in line with our requirements and at the appropriate time, in order to satisfy customer demand. The delays in introduction of new models by the OEMs that we work with, or attractive offerings by competing OEMs also could impact our sales volumes.

The OEMs also provide extended warranty and maintenance contracts to customers. Our authorized service centers perform warranty work for vehicles under OEM product warranties and maintenance contracts and directly bill the OEM as opposed to invoicing the customer. At any particular time, we have significant receivables from our OEMs for warranty work performed for customers under manufacturer product warranties and maintenance contracts. In addition, we rely on our OEMs to varying extents for OEM-authorized replacement parts, training, product brochures and point of sale materials, and other items for outlets.

The OEMs may be adversely impacted by economic downturns, governmental laws and regulations, import restrictions, significant declines in the sales of their new vehicles, natural disasters, pandemics such as COVID-19, increases in interest rates, decline in their credit ratings, labor strikes, supply shortages or rising raw material costs, rising employee benefit costs, vehicle recall campaigns, product defects, unappealing vehicle designs, adverse publicity that may reduce consumer demand for their vehicles, competition from other OEMs, failure to appropriately adapt to changing customer preferences, poor product mix or other adverse events. These and other risks could materially adversely affect the OEMs and impact their ability to profitably design, market, produce or distribute new vehicles, which in turn could materially adversely affect our business operations.

We are subject to a concentration risk in the event of any adverse events or financial distress, including bankruptcy, impacting one or more of these OEMs. Our OEMs are entitled to unilaterally terminate and could attempt to terminate all or certain of their dealership arrangements with us in the event they become insolvent or bankrupt and we may be unable to collect some or all of the receivables due from such OEM(s). Further, consumer demand for such OEM's vehicles could be materially adversely affected. Our business, results of operations, and financial condition could be materially adversely affected as a result of any event that has a material adverse effect on our OEMs.

**15. *Our operations are subject to various governmental laws and regulations and certain state specific notifications and guidelines. If we are found to be in purported violation of or subject to liabilities under any of these laws or regulations, or if new laws or regulations are enacted that adversely affect our operations, our business, operating results, and prospects could suffer.***

The automotive retail industry, including our facilities and operations, are subject to certain state specific guidelines and notifications pertaining to display of number plates, road transport office rules and various other laws and regulations, including those relating to new and pre-owned motor vehicle sales, finance and insurance, consumer protection, consumer privacy, environment, vehicle emissions and fuel economy, health and safety, and employment practices. For details, see “*Key Regulations and Policies*” beginning on page 161. We currently devote significant resources to comply with applicable laws and regulations and we may need to spend additional time, effort, and money to keep our operations and existing or acquired facilities in compliance therewith. Further, the approvals that we obtain may stipulate certain conditions requiring our compliance. If we fail to abide by the conditions mentioned in our existing approvals or fail to obtain any of the approvals or licenses required for our operations, or renewals thereof, in a timely manner, or non-compliance with applicable laws and regulations could result in imposition of fines and penalties which could adversely impact our business, results of operations and financial condition. For further details, please see the section entitled “*Government and Other Approvals*” beginning on page 328.

Further, OEMs are subject to government-mandated fuel economy and greenhouse gas, or GHG, emission standards, which continue to change and become more stringent over time. New vehicles in India are currently required to be Bharat Emission Stage VI compliant. These and other laws and regulations could materially adversely affect the ability of OEMs to produce, and our ability to sell vehicles in demand by consumers at affordable prices, which could materially adversely impact our business, results of operations and financial condition.

**16. *Our success depends, in large part, upon our management team and skilled personnel and on our ability to attract and retain such persons.***

We are highly dependent on the continued services of our management team, including Sanjay Karsandas Thakker, the Chairman and Executive Director of our Company for their strategy and vision. We are also dependent on our experienced Key Managerial Personnel for their expertise. Our future performance is dependent on the continued service of these persons. If one or more of these Key Managerial Personnel are unwilling or unable to continue in their present positions, we may not be able to replace them with persons of comparable skills and expertise. We also face a continuing challenge to hire and assimilate skilled personnel. Competition for management and other skilled personnel is intense, and we may not be able to attract and retain the personnel we need in the future. The loss of key personnel or our inability to replace key personnel may restrict our ability to grow, to execute our strategy, to raise the profile of our brand, to raise funding, to make strategic decisions and to manage the overall running of our operations, which would have a material adverse impact on our results of operations and financial position. For further information on our management team, please see “*Our Management*” beginning on page 178.

**17. *Our success depends on the value, perception and marketing of our dealership brands.***

Our dealerships are operated under a number of brands including our umbrella brand “Group Landmark”, and we believe that our continued success will depend on our ability to maintain and enhance the value of our brands. Although we take many steps to increase our brand awareness and protect the value of our brand through marketing, advertising and promotion, our business is dependent on customers’ perception of our brands, the brands of our OEMs and our marketing, advertising and promotional campaigns. If we adopt unsuccessful marketing and advertising programs and campaigns, we may only incur expenses without the benefit of higher revenues or our competitors may increase their advertising spend which we may not be able to match. Our competitors also may launch promotional activities, concepts, branding and advertising activities, which may increase their brand visibility and we may not be able to match them.

In addition, consumers are increasingly shopping for new and pre-owned vehicles, automotive repair and maintenance services, and other automotive products and services online and through mobile applications, including through online sales platforms. Although our strategy is to continue to build our online and mobile sale channels and digital customer interfaces, our efforts may not gain market acceptance and we may lose brand value and market share to competing online and mobile platforms. Further, we may not be able to invest adequately in marketing or customer engagement which could lead to loss of customers to competitors. If we fail to preserve the value of our retail brands, maintain our reputation, or attract consumers to our own online and digital channels, or provide good after-sale services to our customers, our business, results of operations and financial condition could be adversely impacted.

Further, our brand “Landmark” could be damaged by negative publicity in traditional or social media or by claims or perceptions about the quality of our products and services, regardless of whether such claims or perceptions are true. Any untoward incidents such as litigation, regulatory actions or negative publicity, whether isolated or recurring and whether originating from us or otherwise, affecting our business or suppliers, can significantly reduce our brand value and consumer trust, and accordingly, adversely affect our business, results of operations and financial

condition.

**18. *The agreements governing our indebtedness contain certain restrictive covenants and our inability to comply with these covenants could adversely affect our business, results of operations financial condition.***

We have entered into agreements in relation to financing arrangements with certain banks for short-term and long-term loans, working capital facilities and other borrowings. of September 30, 2021, our consolidated outstanding borrowings of ₹4,088.43 million comprised of non-current borrowings of ₹466.88 million, current borrowings of ₹2,369.29 million and vehicle floor plan of ₹1,252.26 million. Some of these agreements contain requirements to maintain certain security margins, financial ratios and contain restrictive covenants relating to issuance of new shares, changes in capital structure, making material changes to constitutional documents, incurring further indebtedness, encumbrances on or disposal of assets, paying dividends and making investments over certain thresholds. As on date of this Draft Red Herring Prospectus, we have obtained necessary consents from, and made necessary intimations to, our lenders as required under our loan documentation, for undertaking the Offer and related actions. For further details, see “*Financial Indebtedness*” beginning on page 311. Furthermore, some of our financing arrangements specify that upon the occurrence of an event of default, the lender shall have the right to, *inter alia*, cancel the outstanding facilities available for drawdown, declare the loan to be immediately due and payable with accrued interest and enforce rights over the security created. There can be no assurance that we will be able to comply with these financial or other covenants.

Our lenders also have the ability to recall or accelerate all or part of the amounts owed by us, subject to the terms of the financing arrangement. Such recalls may be contingent on happening of an event beyond our control and there can be no assurance that we will be able to persuade our lenders to give us extensions or to refrain from exercising such recalls. There can be no assurance that we will be able to repay our loans in full, or at all, at the receipt of a recall or acceleration notice, or otherwise. Our inability to comply with the conditions prescribed under the financing arrangements, or repay the loans as per the repayment schedule, may have an adverse impact on our credit rating, business operations and future financial performance. Further, if we are unable to service our existing debt, our ability to raise debt in the future will be adversely affected, which will have a material adverse effect on our business, results of operations and financial condition.

**19. *We are required to obtain certain licenses, regulatory permits and approvals for setting up our dealerships and undertaking our operations. Any delay or inability to obtain such approvals may have an adverse impact on our business.***

We are required to obtain certain statutory and regulatory permits, licenses and approvals to operate our business, including approvals from the pollution control board. For details of the material licenses, registrations and approvals for our Company and Material Subsidiaries, see “*Government and Other Approvals*” on page 328. Our approvals may expire from time to time in the ordinary course and we may be required to make applications for such renewals. As on the date of this Draft Red Herring Prospectus, our Company and Material Subsidiaries have applied for or are in the process of applying for renewal of certain expired material approvals as disclosed in “*Government and Other Approvals - Key approvals in relation to the business operations of our Company and Material Subsidiaries*” on page 328. If we fail to obtain the necessary approvals and permits or if there is any delay in obtaining such approvals and permits, it may disrupt our operations, result in the application of penalties and may materially and adversely affect our business, results of operations and financial condition. For further information see “- *AMPL has currently closed one of its service centres pursuant to a direction received from the Commission of Air Quality Management in National Capital Region and Adjoining Areas. We cannot assure you that AMPL will be able to re-open such service centre in a timely manner or at all and/or that no further action will be taken against AMPL*” on page 38.

In the future we will be required to apply for fresh approvals and permits for any new dealerships and service centers. While we believe we will be able to obtain such approvals or permits at such times as may be required, there can be no assurance that the relevant authorities will issue any of such permits or approvals in the time frames anticipated by us or at all. For details of material approvals expired but not yet applied for, see “*Government and Other Approvals- Key approvals in relation to the business operations of our Company and Material Subsidiaries - Approvals in relation to our service centre operations - Material Approvals which have expired and are yet to be applied for*” on page 329.

**20. *AMPL has currently closed one of its service centres pursuant to a direction received from the Commission of Air Quality Management in National Capital Region and Adjoining Areas. We cannot assure you that AMPL will be able to re-open such service centre in a timely manner or at all and/or that no further action will be taken against AMPL.***



AMPL has currently closed one of its service centres located in New Delhi (the “**Service Centre**”) pursuant to a direction for closure dated December 14, 2021 (the “**Direction for Closure**”) received by AMPL from the Commission of Air Quality Management in National Capital Region and Adjoining Areas (the “**Air Quality Commission**”). The Direction for Closure mentions that the Service Centre was found to be operating without the consent to operate from the Delhi Pollution Control Committee, in violation of the directions of the Air Quality Commission. In terms of the Direction for Closure, AMPL has been required to *inter alia* close down all industrial operations/activities of the Service Centre and not resume operations without the prior permission of the Air Quality Commission until further orders from the Air Quality Commission. Further, the relevant officer(s) may also initiate action for prosecution against AMPL. We cannot assure you that we will be able to re-open the Service Centre in a timely manner or at all or that no punitive actions will be taken against AMPL or its officers in this regard. Failure to re-open the Service Centre in a timely manner will adversely impact our ability to service our customers and comply with requirements of our contractual arrangements in relation to the Service Centre which in turn may adversely affect our business, cash flows, results of operations and reputation.

**21. *Our success depends upon our ability to attract, develop and retain trained manpower while also controlling our labor costs.***

Our customers expect a high standard of customer service and product knowledge from our technicians and our sales representatives. Further, modern vehicles are increasingly complex and require sophisticated equipment and specially trained technicians to perform certain services. We also market third-party finance and insurance contracts to our customers. To meet the needs and expectations of our customers, we must attract, train and retain a number of qualified service technicians, store managers and sales representatives, while at the same time controlling labor costs. While we undertake in-house training for our outlet managers and sales representatives, we cannot assure you that we will be able to retain the right personnel. Our dealership agreements also include stipulations with respect to skilled personnel and training of personnel.

We will need to continue to recruit, train and retain a greater number of sales representatives and trained manpower, including service labor like technicians and service staff, at various levels. Our ability to control labor costs is subject to numerous external factors, including prevailing wage rates, as well as the impact of legislation or regulations governing labor relations and minimum wages. An inability to provide wages and benefits that are competitive within the markets in which we operate could adversely affect our ability to retain and attract qualified personnel, which in turn may affect our business, results of operations and financial condition. For instance, we have implemented measures to undertake reductions in salaries for some of our employees on account of the COVID-19 pandemic, any such downward revisions in salaries in future could adversely affect our ability to retain our employees.

**22. *We may be required to make significant capital improvements to our existing sales outlets, service centers and other premises, the cost of which we may be unable to recoup.***

In order to maintain the look and feel in terms of branding and to keep up with requirements of our OEMs, we are required to make significant capital improvements to our existing showrooms, sales outlets, service centers and other premises. This includes carrying out regular repairs and maintenance, replacement of furniture and adopting new interiors in line with the OEM requirements. We may also be required to invest in additional power supply infrastructure at our locations. We cannot assure you that we will be able to obtain such approvals, in a timely manner or at all, and this may have an adverse effect on our business, results of operations and financial condition.

We cannot assure you that investments made in upgrading or refurbishments in our sales outlets, service centers and other premises or further capital expenditure in newer locations or power infrastructure will result in maintaining or increasing our customer base or sales, resulting in increased profits. This may in turn have an adverse effect on our business, results of operations and financial condition.

**23. *We have incurred significant capital expenditure during the last three Fiscal Years. We may require substantial financing for our business operations and planned capital expenditure and the failure to obtain additional financing on terms commercially acceptable to us may adversely affect our ability to grow and our future profitability.***

During the six months ended September 30, 2021, Fiscal 2021, Fiscal 2020 and Fiscal 2019, we incurred capital expenditure on account of additions to property, plant and equipment, other intangible assets, capital work-in-progress and intangible assets under development of ₹239.79 million, ₹119.67 million, ₹195.05 million and ₹1,253.87 million, respectively. A significant amount of our capital expenditure in these periods was used to open new sales outlets and service centers.

In the future, we may require substantial capital for our business operations and planned capital expenditure to maintain and grow our existing dealerships, open new dealerships, develop and implement new technologies to enhance our business process and develop and operate online and digital platforms. The actual amount and timing of our future capital requirements may differ from estimates as a result of, among other things, unforeseen delays or cost overruns in developing our projects, changes in business plans due to prevailing economic conditions, unanticipated expenses and regulatory changes. To the extent our planned expenditure requirements exceed our available resources, we will be required to seek additional debt or equity financing. Additional debt financing could increase our interest costs and require us to comply with additional restrictive covenants in our financing agreements. Additional equity financing could dilute our earnings per Equity Share and could adversely impact our future Equity Share price.

Our ability to obtain additional financing on favorable terms, if at all, will depend on a number of factors, including our future financial condition, results of operations and cash flows, the amount and terms of our existing indebtedness, general market conditions and market conditions for financing activities and the economic, political and other conditions in the markets where we operate. Our ability to raise debt financing on acceptable terms also depends on our credit ratings. For further information on the risks associated with credit ratings, see “*Any downgrade of our debt ratings could adversely affect our business*”. We cannot assure you that we will be able to raise additional financing on acceptable terms in a timely manner or at all. Our failure to renew arrangements for existing funding or to obtain additional financing on acceptable terms and in a timely manner could adversely impact our planned capital expenditure, our business, results of operations and financial condition.

**24. *Our Company and Subsidiaries have unsecured loans which are repayable on demand. Any demand from lenders for repayment of such unsecured loans may adversely affect our cash flows.***

As of September 30, 2021, our Company’s consolidated unsecured loans amounts to ₹ 584.78 million, and we may in the future continue to avail unsecured borrowings (such as loans from our directors, banks and inter-corporate loans), which may be recalled at any time, with or without the existence of an event of default, on short or no notice. Such recalls on borrowed amounts may be contingent upon happening of an event beyond our control and there can be no assurance that we will be able to persuade our lender to give us extensions or to refrain from exercising such recalls, which may adversely affect our business, results of operations and cash flows. For further details, see “*Financial Indebtedness*” on page 311.

**25. *A failure of our information systems or any security breach or unauthorized disclosure of confidential information could damage our reputation and harm our business, results of operations and financial condition, and any changes in laws or regulations relating to privacy or the protection or transfer of data or any failure by us to comply with such laws or regulations or any other obligations relating to privacy or the protection or transfer of data relating to our customers, could have a material adverse effect on our business.***

Our business is dependent upon the efficient operation of our information systems. We rely on our information systems to manage, among other things, our sales, inventory, and service efforts, including through our digital channels, and customer information, as well as to prepare our consolidated financial and operating data. The failure of our information systems to perform as designed or the failure to maintain and enhance or protect the integrity of these systems could disrupt our business operations, impact sales and results of operations, expose us to customer or third-party claims, or result in adverse publicity. Additionally, we collect, process, and retain sensitive and confidential customer information in the normal course of our business. Despite the security measures we have in place and any additional measures we may implement in the future, our facilities and systems, and those of our third-party service providers, could experience security breaches, computer viruses, lost or misplaced data, programming errors, human errors, acts of vandalism or other events.

Any system failure, security breach, third-party attacks or event resulting in the misappropriation, loss, or other unauthorized disclosure of confidential information, whether by us directly or our third-party service providers, could damage our reputation, and brand, deter current and potential consumers from using our services, expose us to the risks of litigation and liability, disrupt our business or otherwise affect our results of operations.

Several laws and regulations address privacy and the collection, storing, sharing, use, and protection of certain types of data. These laws, rules, and regulations evolve frequently and their scope may continually change, through new legislation, amendments to existing legislation, and changes in enforcement. Such changes in laws or regulations, particularly any new or modified laws or regulations, or changes to the interpretation or enforcement of such laws or regulations, that require enhanced protection of certain types of data or new obligations with regard to data retention and transfer, could greatly increase our costs and require significant changes to our operations.

With the proposed enactment of the Personal Data Protection Bill, 2019 (“**PDP Bill**”), and the ongoing regulatory discussions on the proposed Indian regulation to govern non-personal data, the privacy and data protection laws are set to be closely administered in India, and we may become subject to additional potential compliance requirements. The PDP Bill proposes a legal framework governing the processing of personal data, where such data has been collected, disclosed, shared or otherwise processed within India, as well as any processing of personal data by the Government of India, Indian companies, Indian citizens or any person or body of persons incorporated or created under Indian law. The PDP Bill defines personal data and sensitive personal data, prescribes rules for collecting, storing and processing of such data and creates rights and obligations of data-subjects and processors. The Indian Government has also been mooting a legislation governing non-personal data. In September 2019, the Ministry of Electronics and Information Technology formed a committee of experts (“**NPD Committee**”) to recommend a regulatory regime to govern non- personal data (“**NPD**”). The NPD Committee has released two reports till date, which recommend, among other items, a framework to govern NPD (defined as any data other than personal data), access and sharing of NPD with government and corporations alike and a registration regime and for “data businesses”, being business that collect, process or store data, both personal and non-personal. Should such a framework be notified, our ability to collect, use and transfer information with respect to our counterparties may be further restricted. Our failure to take reasonable security precautions, safeguard personal information or collect such information in the future may have a material adverse effect on our business, financial condition and results of operations.

As part of our operations, we are required to comply with the IT Act and the rules thereof, which provides for civil and criminal liability including compensation to persons affected, penalties and imprisonment for various cyber related offenses, including unauthorized disclosure of confidential information and failure to protect sensitive personal data. India has already implemented certain privacy laws, including the Information Technology (Reasonable Security Practices and Procedures and Sensitive Personal Data or Information) Rules, 2011 and the recently introduced the Information Technology (Intermediary Guidelines and Digital Media Ethics Code) Rules, 2021, which impose limitations and restrictions on the collection, use, disclosure and transfer of personal information.

We have incurred, and may continue to incur, significant expenses in an effort to comply with privacy, data protection, and information security standards and protocols imposed by laws, regulations, industry standards, or contractual obligations. Our attempts to comply with applicable legal requirements may not be successful, and may also lead to increased costs for compliance, which may adversely affect our business, results of operations and financial condition. We could be adversely affected if legislations or regulations are expanded or amended to require changes in our business practices, or if such legislations or regulations are interpreted or implemented in ways that negatively affect our business, results of operations and financial condition. Non-compliance with applicable regulations or requirements could subject us to investigations, enforcement actions, and sanctions, fines, and damages, civil and criminal penalties or injunctions, claims for damages by our customers or business collaboration partners and termination of contracts.

**26. *Accidents and natural disasters could result in the slowdown or stoppage of our business and could also cause us to incur liabilities arising from human fatalities and damage to property.***

Our machines and operations at our service centers are subject to hazards inherent to our after-sales operations. Risks related to work accidents, fire or explosion, including hazards that may cause injury and loss of life, severe loss or damage to property and environment may be present on our premises. For instance, in 2017, due to leakage of oil one of our service centers caught fire. Similarly, in 2020, at one of our service centers caught fire due to short circuit. For further details, see “*Restated Consolidated Financial Information- Note 48. Loss due to fire*” on page 263. While no legal proceedings or penalties were imposed on us on account of such hazards or risks in the past, any such incidents in future, may result in imposition of civil or criminal penalties on us irrespective of whether the incidents were caused by our negligence or any fault on our part. In addition, such events could cause a slowdown or stoppage of our operations which could adversely affect our business, results of operations and financial condition. Further, natural disasters or severe weather conditions, including earthquakes, fires, heavy rains and flooding, could damage our property including our inventory of vehicles, and/or disrupt our business activities and thereby adversely affect our business, results of operations and financial condition. Owing to the rains and consequent flooding in various parts of Mumbai, during July 2021 there was damage to our inventory.

**27. *Failure or disruption of our IT, ERP systems and/or online platforms and mobile applications may adversely affect our business, results of operations and financial condition.***

We have implemented various information technology (“**IT**”) and/or enterprise resource planning (“**ERP**”) solutions to cover key areas of our operations, sales, procurement, customer interfaces, finances and accounting. We also

maintain a significant online interface with our customers through our websites and mobile applications. These systems, websites and applications are potentially vulnerable to damage or interruption from a variety of sources, which could result from (among other causes) cyber-attacks on or failures of such infrastructure or compromises to its physical security, as well as from damaging weather or other acts of nature. A significant or large-scale malfunction or interruption of one or more of our IT systems, ERP systems or online customer interfaces could adversely affect our ability to keep our operations running efficiently and affect our services in the region or functional area in which the malfunction occurs, and wider or sustained disruption to our business cannot be excluded. In addition, it is possible that a malfunction of our data system security measures could enable unauthorized persons to access sensitive business data, including information relating to our intellectual property or business strategy or those of our customers. Such malfunction or disruptions could cause economic losses for which we could be held liable or cause damage to our reputation. Our dealership agreements also contain certain specifications with respect to maintenance of IT systems and the failure to comply with the requirements may result in us being in breach of such dealership agreements. Any of these developments, alone or in combination, could have a material adverse effect on our business, results of operations and financial condition. Further, unavailability of, or failure to retain, well trained employees capable of constantly servicing our IT, ERP systems and/or online platforms and mobile applications may lead to inefficiency or disruption of our operations and thereby adversely affecting our business, results of operations and financial condition.

**28. *Our passenger vehicles and commercial vehicles sales are subject to seasonality, which may contribute to fluctuations in our results of operations.***

Demand for automobiles in India tends to fluctuate between different periods within a fiscal year. Due to the Dusshera - Diwali festive season which falls in October / November as per the Panchanga / Hindu calendar and annual price increases instituted in January of each year, the October-December months tend to be the strongest sales period in any given fiscal year, while the remainder of the year is relatively average on sales performance. Accordingly, our results of operations in one quarter may not accurately reflect the trends for the entire financial year and may not be comparable with our results of operations for other quarters. During these periods, we may continue to incur operating expenses, but our income from operations may be delayed or reduced. This seasonality can also be expected to cause quarterly fluctuations in our revenue, profit margins and earnings.

**29. *We are subject to risks associated with leasing space such as termination of, non-renewal of or failure to enforce, register or adequately stamp our lease agreements and we may not be able to operate our dealerships successfully.***

We lease most of the properties occupied by our automotive dealerships. During the six months ended September 30, 2021, Fiscal 2021, Fiscal 2020 and Fiscal 2019, cash outflow for leases were ₹241.87 million, ₹357.72 million, ₹446.95 million and ₹368.78 million, respectively, and rent expense for short term leases charged to Statement of Profit and Loss were ₹22.55 million, ₹38.53 million, ₹63.69 million and ₹132.18 million, respectively. We expect any dealerships, which we open in the future to be on leased property. Further, some of the lease agreements are currently in the process of renewal and we cannot assure that we will be able to renew the lease deeds on favorable terms. If our lease agreements expire and are not renewed by us within the time stipulated under any such agreement, we will be required to vacate such premises, and may be required to identify alternative premises at less favourable terms which could affect our operations and profitability. Further, our lease agreements for our sales outlets, service centers and other premises may not be duly registered or adequately stamped and may not be accepted as evidence in a court of law, we may be required to pay penalties for inadequate stamping and non-registration. In the event of any dispute arising out of such unstamped or inadequately stamped and/or unregistered lease agreements, we may not be able to effectively enforce our leasehold rights arising out of such agreements, which may have an adverse impact on our business, results of operations and financial condition.

Further, in most of the leases for our sales outlets, service centers and other premises, we cannot terminate the lease agreement, unless we provide the owners with a written notice. As our leases expire, we may fail to negotiate renewals, either on commercially acceptable terms or at all, which could cause us to pay increased occupancy costs or to close sales outlets and service centers in desirable locations or to shift them, which may have an adverse impact on our business, results of operations and financial condition.

**30. *There are outstanding legal proceedings involving our Company, Subsidiaries, Promoter and Directors, and adverse outcomes in such proceedings may negatively affect our business, results of operations and financial condition.***

As on the date of this Draft Red Herring Prospectus, our Company, Subsidiaries, Promoter and Directors are involved in certain legal proceedings which are pending at different levels of adjudication before various courts, tribunals and appellate authorities. A summary of outstanding litigation in relation to criminal matters, actions by statutory and

regulatory authorities, tax proceedings and certain other material litigation involving our Company, Subsidiaries, Promoter and Directors, as disclosed in the chapter “*Outstanding Litigation and Other Material Developments*” on page 314, in accordance with requirements under the SEBI ICDR Regulations and the Materiality Policy is set out below:

Name of entity	Criminal proceedings	Tax proceedings	Statutory or regulatory proceedings	Disciplinary actions by the SEBI or Stock Exchanges against our Promoter	Material civil litigation	Aggregate* amount involved (₹ in million)
<b>Company</b>						
By the Company	4	-	-	-	-	0.41
Against the Company	-	8	-	-	8	207.23
<b>Directors</b>						
By our Directors	-	-	-	-	-	-
Against the Directors	1	-	-	-	-	53.10
<b>Promoter</b>						
By Promoter	-	-	-	-	-	-
Against Promoter	1	-	-	-	-	53.10
<b>Subsidiaries</b>						
By Subsidiaries	3	-	-	-	1	10.09
Against Subsidiaries	4	20	1	-	14	291.16

\*To the extent quantifiable.

For further details of the outstanding litigation proceedings, see “*Outstanding Litigation and Material Developments*” on page 314.

The amounts claimed in these proceedings have been disclosed to the extent ascertainable and include amounts claimed jointly and severally. Such proceedings could divert management time and attention and consume financial resources in their defense or prosecution. If any new developments arise, such as a change in Indian law or rulings against us by appellate courts or tribunals, we may need to make provisions in our financial statements that could increase our expenses and current liabilities. We cannot assure you that these legal proceedings will be decided in favor of our Company, Subsidiaries, Promoter and/or Directors, or that no further liability will arise out of these proceedings. Decisions in any of the aforesaid proceedings adverse to our interests may have a material adverse effect on our business, results of operations and financial condition. Even if we are successful in defending such cases, we will be subject to legal and other associated costs, which may be substantial.

**31. Our inability or failure to maintain optimum inventory levels or any theft of inventory may adversely affect our business, results of operations and financial condition.**

We retail multiple models of vehicles through each of our dealerships and also service new passenger and commercial vehicles through our service centers. Additionally, we retail spare parts and accessories of vehicles through our dealerships and our distributorship channels. For undertaking these activities, we are required to have strong inventory management in place. We strive to keep optimum inventory at our sales outlets, service centers and stockyards to control our costs and working capital requirements and comply with stipulations with respect to inventory from our OEMs. We are also required to accurately predict the market demand for each of the vehicle models that we retail as well as for the levels of inventory including oils, paints and lubricants that we utilize at our after-sales service and spares outlets. Our inability or failure to maintain adequate inventory levels may affect our quality of service, relationships with our OEMs and our business reputation. Conversely, an inaccurate forecast may result in an over-supply or shortage of products, which may lead to increase inventory costs, negatively impact cash flow and ultimately lead to reduction in margins. Further, any inability on our part to prevent theft of inventory, or any illegal use/ misuse of the inventory may adversely affect our business, results of operations and financial condition.

**32. Our Promoter, certain of the members of the Promoter Group, our Directors and Key Management Personnel have interests in our business other than reimbursement of expenses incurred or normal remuneration or benefits.**

Our Promoter and certain of the members of the Promoter Group, Directors and Key Management Personnel are interested in our Company, in addition to regular remuneration or benefits and reimbursement of expenses, to the extent of their shareholding in our Company and the benefits arising therefrom. For instance, as on the date of this

Draft Red Herring Prospectus, Sanjay Karsandas Thakker, our Promoter, Chairman and Executive Director holds 41.38% of our issued and paid-up Equity Share capital, (jointly with Ami Sanjay Thakker). Further, Aryaman Sanjay Thakker, our Executive Director and a member of the Promoter Group, holds 1.54% of our issued and paid-up Equity Share capital, (jointly with Sanjay Karsandas Thakker). For details of the shareholding of our Promoter, members of the Promoter Group, Directors and Key Managerial Personnel, see “*Capital Structure- Details of shareholding of our Promoter and members of the Promoter Group in our Company*”, “*Our Management-Shareholding of Directors of our Company*” and “*Our Management-Shareholding of the Key Managerial Personnel*” on page 84, 184 and 195.

Further, certain of our Key Managerial Personnel are also interested to the extent of options granted to them pursuant to the ESOP Scheme. We cannot assure you that our Key Managerial Personnel will exercise their rights as shareholders to the benefit and best interest of our Company. Our Key Managerial Personnel may take or block actions with respect to our business which may conflict with the best interests of our Company or that of minority shareholders. For further information on the interests of our Promoter, Directors and Key Managerial Personnel of our Company, other than reimbursement of expenses incurred or normal remuneration or benefits, see “*Our Management*” and “*Our Promoter and Promoter Group*” beginning on pages 178 and 196, respectively.

Further, Sanjay Karsandas Thakker and Aryaman Sanjay Thakker are also interested to the extent of a loan extended by them to our Company. For further information on the interests of our Promoter and Directors and of our Company, other than reimbursement of expenses incurred or normal remuneration or benefits, see “*Our Management*” and “*Our Promoter and Promoter Group*” beginning on pages 178 and 196, respectively.

**33. *Our Promoter has provided personal guarantees for certain borrowings obtained by us, and any failure or default by us to repay such loans could trigger repayment obligations on our Promoter, which may impact our Promoter’s ability to effectively service their obligations as our Promoter and thereby, adversely impact our business and operations.***

As of November 30, 2021, certain of our secured and unsecured borrowings are backed by personal guarantees provided by our Promoter. For further details in relation to our borrowings, see “*Financial Indebtedness*” on page 311. Any default or failure by us to repay our loans in a timely manner or at all could trigger repayment obligations on the part of our Promoter in respect of such loans. This, in turn, could have an impact on his ability to effectively service his obligations as the Promoter of our Company, thereby having an adverse effect on our business, results of operations and financial condition.

Further, in the event that our Promoter withdraws or terminates the guarantees, our lenders for such facilities may ask for alternate guarantees, repayment of amounts outstanding under such facilities, or even terminate such facilities. We may not be successful in procuring guarantees satisfactory to the lenders, and as a result may need to repay outstanding amounts under such facilities or seek additional sources of capital, which could affect our business, results of operations and financial condition.

**34. *Our insurance coverage may not be adequate to protect us against all potential losses, which may have a material adverse effect on our business, financial condition and results of operations.***

Our operations are subject to various risks inherent to the automobile retail industry, as well as other risks such as theft, robbery, acts of terrorism and other force majeure events. We maintain insurance coverage for anticipated risks which are standard for our type of business and operations. As of September 30, 2021, Fiscal 2021, Fiscal 2020 and Fiscal 2019, all of our consolidated assets were covered under our insurance policy. Our insurance policies cover our sales outlets, service centers and other properties from losses in the case of fire, special perils, burglary and theft. We have also obtained inventory insurance, money insurance for cash in transit, fidelity insurance, directors’ and officers’ liability insurance, plate glass insurance for accidental breakage of fixed plate glass in our showrooms, service centers and other units and internal risk insurance for cases of bodily injuries, property damage, and damage to our vehicles. Notwithstanding the insurance coverage that we carry, we may not be fully insured against certain business risks. There are many events that could significantly impact our operations, or expose us to third-party liabilities, for which we may not be adequately insured. There can be no assurance that any claim under the insurance policies maintained by us will be honored fully, in part, or on time. To the extent that we suffer any loss or damage that is not covered by insurance or exceeds our insurance coverage, our business, results of operations and financial condition could be adversely affected.

**35. *Any closure of our outlets and service centers, which may result in a reduction of revenue and negatively impact our business, results of operations and financial condition.***

We have in the past permanently terminated certain dealerships owing to market conditions. For instance, we closed

our dealership for an OEM in Pune in Fiscal 2021, which we operated for over three years, on account of commercial considerations. Further, our facilities were required to be temporarily closed down on account of the COVID-19 induced lock-down restrictions imposed by State Governments in the jurisdictions in which we operate. For details see “- *The COVID-19 pandemic had a material adverse effect on our business, results of operations and financial condition and the continuing impact of the COVID-19 pandemic is uncertain and still evolving, and could continue to adversely affect our business, results of operations and financial condition*” and “*Our Business – Recent Developments – COVID 19 Pandemic*” on page 33 and 159, respectively. Permanent or temporary closure of a large number of our sales outlets or after-sales service and spares outlets for prolonged periods of time or termination of dealerships in the future may result in a reduction of revenue and negatively impact our business, results of operations and financial condition.

**36. *We may be subject to significant liability should there be any deficiencies in any of the vehicles sold by us or services provided by us resulting in injury or death.***

There could be deficiencies in vehicles sold by us or services performed by us at our service centers which could lead to serious injury or death. Claims, including product liability claims may be asserted against us (along with our OEMs) with respect to any of the vehicles we sell or service. For details of certain outstanding litigation proceedings initiated against us with respect to deficiency in services or manufacturing defects, see “*Outstanding Litigation and Other Material Developments-Litigation involving our Company- Outstanding litigation proceedings against our Company - Other material pending proceedings*” on page 315. A product liability judgment against us, with material financial impact, could have a material, adverse effect on our business, results of operations and financial condition.

**37. *Our intellectual property rights may be subject to infringement or we may breach third party intellectual property rights.***

Our trade name “*Landmark*” and our logos that include the head of the lion are registered with the Trademarks Registry, Ahmedabad and the registrations are valid until July 31, 2028. For other registered trade names and their details, please see “*Our Business-Intellectual Property*” on page 159. There can be no assurance that any third parties will not infringe on our intellectual property, causing damage to our business prospects, reputation and goodwill.

We may need to litigate to protect our intellectual property or to defend against third party infringement. Any such litigation could be time consuming and costly and the outcome cannot be guaranteed. We may not be able to detect any unauthorized use or take appropriate and timely steps to enforce or protect our intellectual property.

Further, we have also made fresh applications for registering additional trademarks and certain of our applications have been objected. With respect to our pending trademark applications and/or objections or oppositions raised thereon, we cannot assure you that we will be successful in such challenges nor can we guarantee that the registration will be granted. As a result, we may not be able to prevent infringement of our trademarks and a passing off action may not provide sufficient protection until such time that this registration is granted.

Any inability to use or protect our intellectual property could affect our relationships with our customers, which could materially and adversely affect our brand, business, results of operations and financial condition.

We may also be subject to claims by third parties if we breach their intellectual property rights by using slogans, names, designs, software or other such subjects, which are of a similar nature to the intellectual property these third parties may have registered. Any legal proceedings that result in a finding that we have breached third parties’ intellectual property rights, or any settlements concerning such claims, may require us to provide financial compensation to such third parties or make changes to our marketing strategies or to the brand names of our products, which may have a materially adverse effect on our brand, business, results of operations and financial condition.

**38. *We may be subject to labor unrest, slowdowns and increased wage costs, which may adversely affect our business, results of operations and financial condition.***

As of September 30, 2021, our network includes 112\* outlets, comprised of 61 sales showrooms and outlets and 51\* after-sales service and spares outlets. Our vehicle dealership network is spread across 31 cities in 8 states and union territories including Maharashtra, Gujarat, Haryana, Madhya Pradesh, Uttar Pradesh, Punjab, West Bengal and the National Capital Territory of Delhi. While our employees are not unionized currently, there is no assurance that our employees will not seek unionization in the future. In the event that employees at our sales outlets or service centers seek to unionize, it may become difficult for us to maintain flexible labor policies and may increase our costs and adversely affect our business, results of operations and financial condition. Any strikes or lockouts, work stoppages, slowdowns, shutdowns, supply interruptions or costs or other factors beyond our control, may disrupt our operations

and could negatively impact our business, results of operations and financial condition.

\*includes acquisition of 4 after sales service and spares outlets pursuant to acquisition of Shaman Wheels Private Limited w.e.f. October 1, 2021.

**39. *We engage contract labor for carrying out certain business operations.***

In order to retain operational efficiencies, we engage independent contractors through whom we engage contract labour for performance of certain functions at our sales units, service centres and offices. Although we do not engage these labourers directly, we are responsible for any wage payments to be made to such labourers in the event of default by such independent contractors. Any requirement to fund their wage requirements may have an adverse impact on our business, results of operations and financial condition.

**40. *This Draft Red Herring Prospectus contains information from industry sources including the industry report commissioned from CRISIL Research and paid for by the Company. Investors are advised not to place undue reliance on such information.***

This Draft Red Herring Prospectus includes information derived from third party industry sources and from the CRISIL Report. We commissioned, and paid for, the CRISIL Report exclusively for the purpose of confirming our understanding of the industry in connection with the Offer. Further, the reports use certain methodologies for market sizing and forecasting. There are no standard data gathering methodologies in the markets in which we operate, and methodologies and assumptions vary widely among different industry sources. Such assumptions may change based on various factors. We cannot assure you that such assumptions are correct or will not change and, accordingly, our position in the market may differ from that presented in this Draft Red Herring Prospectus. Industry sources and publications are also prepared based on information as of specific dates and may no longer be current or reflect current trends. Industry sources and publications may also base their information on estimates, projections, forecasts and assumptions that may prove to be incorrect. While industry sources typically take due care and caution while preparing their reports, they do not guarantee the accuracy, adequacy or completeness of the data or report and do not take responsibility for any errors or omissions or for the results obtained from using their data or report.

Further, the CRISIL Report or any other industry data or sources are not recommendations to invest in our Company. You should consult your own advisors and undertake an independent assessment of information in this Draft Red Herring Prospectus based on, or derived from, the CRISIL Report. You are advised not to place undue reliance on the CRISIL Report or extracts thereof as included in this Draft Red Herring Prospectus, when making your investment decision. Also, see “*Certain Conventions, Use of Financial Information, Industry and Market Data and Currency of Presentation —Industry and Market Data and “Industry Overview”*” beginning on pages 16 and 105, respectively.

**41. *Our Promoter and members of the Promoter Group will continue to hold a significant equity stake in our Company after the Offer and their interests may differ from those of the other shareholders.***

The aggregate pre-Offer shareholding of our Promoter and members of the Promoter Group, as of the date of this Draft Red Herring Prospectus is 60.24% of the issued, subscribed and paid-up Equity Share capital of our Company. For details, see “*Capital Structure*” beginning on page 76. Our Promoter and members of the Promoter Group will therefore have the ability to influence our operations significantly. This will include the ability to appoint Directors to our Board and the right to approve significant actions at Board and at shareholders’ meetings including issue of Equity Shares, payment of dividends, determining business plans and mergers and acquisitions strategies. Further, if, in the future, our Promoter and/or members of the Promoter Group are unwilling to dilute their equity stake in our Company and do not, or are unable to, fund us, our growth may be affected. In addition, the trading price of the Equity Shares could be materially adversely affected if potential new investors are disinclined to invest in us because they perceive disadvantages to a large shareholding being concentrated in the hands of our Promoter and members of the Promoter Group.

**42. *Our Promoter and the Investor Selling Shareholder shall, subject to Shareholders’ approval by way of a special resolution, continue to hold certain special rights in our Company after listing of the Equity Shares.***

Subject to approval by our Shareholders by way of a special resolution post listing of the Equity Shares, our Promoter shall have the right to elect the Chairman of our Company and the Investor Selling Shareholder shall have the right to nominate one Director to our Board, so long as the Investor Selling Shareholder (together with its affiliates) continues to hold 5% of the issued and paid-up Equity Share capital of our Company. For further details, see “*History and Certain Corporate Matters- Details of subsisting shareholders agreements*” on page 171 and “*Main Provisions of the Articles of Association*” beginning on page 371.



**43. We have entered into, and will continue to enter into, related party transactions, which may potentially involve conflicts of interest with the Shareholders.**

In the ordinary course of our business, we have entered into, and will continue to enter into, transactions with related parties. We have entered into certain transactions with related parties, including with respect to the payment of remuneration of our directors and our Key Managerial Personnel, receipt and payment of loans and interest on the loans obtained from our Promoters and payment of rent to our Promoters and their relatives. While we believe that all such related party transactions that we have entered into are legitimate business transactions conducted on an arms' length basis, we cannot assure you that we could not have achieved more favorable terms had such arrangements not been entered into with related parties. Further, we cannot assure you that these or any future related party transactions that we may enter into, individually or in the aggregate, will not have an adverse effect on our business, results of operations and financial condition. Further, the transactions we have entered into and any future transactions with our related parties have involved or could potentially involve conflicts of interest which may be detrimental to our Company and the Shareholders. For further details regarding our related party transactions, see the section "Financial Information - Related Party Transactions" as disclosed on page 271.

**44. Our Subsidiaries may not pay cash dividends on shares that we hold in them. Consequently, our Company may not receive any return on investments in our Subsidiaries.**

Our Subsidiaries are separate and distinct legal entities, having no obligation to pay dividends and may be restricted from doing so by law or contract, including applicable laws, charter provisions and the terms of their financing arrangements. We cannot assure you that our Subsidiaries will generate sufficient profits and cash flows, or otherwise be able to pay dividends to us in the future. For further details on our Subsidiaries, please see "Our Subsidiaries" beginning on 173.

**45. We have certain contingent liabilities and commitments, which, if they materialise, may affect our financial condition.**

We have certain contingent liabilities that have not been provided for in our financial statements, which if they materialise, may adversely affect our business, result of operations and/or financial condition As of September 30, 2021, we had contingent liabilities amounting to ₹2,143.32 million.

Contingent liabilities and commitments, to the extent not provided for, as of September 30, 2021, March 31, 2021, 2020 and 2019, as determined in accordance with Ind AS 37, are described below:

Contingent liabilities	As at September 30, 2021	As at March 31,		
		2021	2020	2019
Matters with GST authorities	21.96	19.75	-	-
Matters with service tax authorities	217.24	217.24	212.00	-
Matters with income tax authorities	1.30	3.53	3.53	-
Matters with VAT authorities	6.04	6.04	2.91	2.91
Matters with local authorities	21.45	-	-	-
Corporate guarantees outstanding	1,875.33	1,524.47	2,629.50	2,629.50
<b>Total</b>	<b>2,143.32</b>	<b>1,771.03</b>	<b>2,847.94</b>	<b>2,632.41</b>

(₹ in millions)

For details, see "Restated Consolidated Financial Information- Notes to Restated Consolidated Financial Information – Note 37 – Contingent Liabilities and Commitments" on page 245.

Most of the liabilities have been incurred in the normal course of business. If these contingent liabilities were to fully materialize or materialize at a level higher than we expect, it may materially and adversely impact our business, results of operations and/or financial condition. For further information, see "Restated Consolidated Financial Information- Notes to Restated Consolidated Financial Information – Note 37 – Contingent Liabilities and Commitments" on page 245.

**46. If we are unable to establish and maintain an effective internal controls and compliance system, our business and reputation could be adversely affected.**

We are responsible for establishing and maintaining adequate internal measures commensurate with the size and complexity of operations. Our internal audit functions make an evaluation of the adequacy and effectiveness of internal systems on an ongoing basis so that our operations adhere to our policies, compliance requirements and

internal guidelines. We periodically test and update our internal processes and systems and there have been no past material instances of failure to maintain effective internal controls and compliance system. However, we are exposed to operational risks arising from the potential inadequacy or failure of internal processes or systems, and our actions may not be sufficient to ensure effective internal checks and balances in all circumstances.

We take reasonable steps to maintain appropriate procedures for compliance and disclosure and to maintain effective internal controls over our financial reporting so that we produce reliable financial reports and prevent financial fraud. As risks evolve and develop, internal controls must be reviewed on an ongoing basis. Maintaining such internal controls requires human diligence and compliance and is therefore subject to lapses in judgment and failures that result from human error. Any lapses in judgment or failures that result from human error can affect the accuracy of our financial reporting, resulting in a loss of investor confidence and a decline in the price of our equity shares.

Further, our operations are subject to anti-corruption laws and regulations. These laws generally prohibit us and our employees and intermediaries from bribing, being bribed or making other prohibited payments to government officials or other persons to obtain or retain business or gain some other business advantage. We participate in collaborations and relationships with third parties whose actions could potentially subject us to liability under these laws or other local anti-corruption laws. While our code of conduct requires our employees and intermediaries to comply with all applicable laws, and we continue to enhance our policies and procedures in an effort to ensure compliance with applicable anti-corruption laws and regulations, these measures may not prevent the breach of such anti-corruption laws, as there are risks of such breaches in emerging markets, such as India. If we are not in compliance with applicable anti-corruption laws, we may be subject to criminal and civil penalties, disgorgement and other sanctions and remedial measures, and legal expenses, which could have an adverse impact on our business, results of operations and financial condition. Likewise, any investigation of any potential violations of anti-corruption laws by the relevant authorities could also have an adverse impact on our business and reputation.

**47. Any variation in the utilization of the Net Proceeds would be subject to certain compliance requirements, including prior shareholders' approval.**

Our proposed objects of the Offer are set forth under “*Objects of the Offer*” beginning on page 89. At this stage, we cannot determine with any certainty if we would require the Net Proceeds to meet any other expenditure or fund any exigencies arising out of competitive environment, business conditions, economic conditions or other factors beyond our control. In accordance with Sections 13(8) and 27 of the Companies Act 2013, we cannot undertake any variation in the utilization of the Net Proceeds without obtaining the shareholders' approval through a special resolution. In the event of any such circumstances that require us to undertake variation in the disclosed utilization of the Net Proceeds, we may not be able to obtain the shareholders' approval in a timely manner, or at all. Any delay or inability in obtaining such shareholders' approval may adversely affect our business, results of operations and financial condition.

Further, our Promoter or controlling shareholders would be required to provide an exit opportunity to Shareholders who do not agree with our proposal to change the objects of the Issue or vary the terms of such contracts, at a price and manner as prescribed by SEBI. Additionally, the requirement on Promoter or controlling shareholders to provide an exit opportunity to such dissenting shareholders may deter the Promoter or controlling shareholders from agreeing to the variation of the proposed utilization of the Net Proceeds, even if such variation is in the interest of our Company. Further, we cannot assure you that the Promoter or the controlling shareholders of our Company will have adequate resources at their disposal at all times to enable them to provide an exit opportunity at the price prescribed by SEBI. In light of these factors, we may not be able to undertake variation of objects of the Offer to use any unutilized proceeds of the Offer, if any, or vary the terms of any contract referred to in the Draft Red Herring Prospectus, even if such variation is in the interest of our Company. This may restrict our Company's ability to respond to any change in our business or financial condition by re-deploying the unutilized portion of Net Proceeds, if any, or varying the terms of contract, which may adversely affect our business, results of operations and financial condition.

**48. Our funding requirements and the proposed deployment of Net Proceeds have not been appraised by any bank or financial institution or any other independent agency and our management will have broad discretion over the use of the Net Proceeds.**

We intend to utilize the Net Proceeds of the Offer as set forth in “*Objects of the Offer*” beginning on page 89. The funding requirements mentioned as a part of the objects of the Offer are based on internal management estimates in view of past expenditures and have not been appraised by any bank or financial institution. This is based on current conditions and is subject to change in light of changes in external circumstances, costs, business initiatives, other financial conditions or business strategies and since we have not presently entered into any definitive agreements for

the use of Net Proceeds.

Various risks and uncertainties, including those set forth in this section, may limit or delay our efforts to use the Net Proceeds to achieve profitable growth in our business. For example, we may also use funds for future businesses and products which may have risks significantly different from what we currently face or may expect. Further, we may not be able to attract personnel with sufficient skills or sufficiently train our personnel to manage our expansion plans.

Accordingly, use of the Net Proceeds for other purposes identified by our management may not result in actual growth of our business, increased profitability or an increase in the value of our business and your investment. For further details, please see “*Objects of the Offer*” beginning on page 89.

**49. *We track certain operational metrics with internal systems and tools. Certain of our operational metrics are subject to inherent challenges in measurement which may adversely affect our business and reputation.***

We track certain operational metrics, including transaction volumes and key business and non-GAAP metrics such as EBITDA, EBITDA Margin, Net Profit Ratio, Return on Equity Ratio, Return on Capital Employed and Net Debt /EBITDA Ratio, among others, with internal systems and tools and which may differ from estimates or similar metrics published by third parties due to differences in sources, methodologies, or the assumptions on which we rely. Our internal systems and tools have a number of limitations, and our methodologies for tracking these metrics may change over time, which could result in unexpected changes to our metrics, including the metrics we publicly disclose. If the internal systems and tools we use to track these metrics undercount or over count performance or contain algorithmic or other technical errors, the data we report may not be accurate. While these numbers are based on what we believe to be reasonable estimates of our metrics for the applicable period of measurement, there are inherent challenges in measuring how our platforms are used across large populations. In addition, limitations or errors with respect to how we measure data or with respect to the data that we measure may affect our understanding of certain details of our business, which could affect our long-term strategies. If our operating metrics are not accurate representations of our business, if investors do not perceive our operating metrics to be accurate, or if we discover material inaccuracies with respect to these figures, we expect that our business, results of operations and financial condition would be adversely affected.

**50. *We will not receive any proceeds from the Offer for Sale. The Selling Shareholders will receive the entire proceeds from the Offer for Sale.***

The Offer includes a Fresh Issue and an Offer for Sale of Equity Shares by the Selling Shareholders. While our Company will receive the entire proceeds from the Fresh Issue, the entire proceeds from the Offer for Sale will only be paid to the Selling Shareholders and we will not receive any such proceeds. For further details, see “*The Offer*” and “*Objects of the Offer*” on pages 60 and 88, respectively.

## **EXTERNAL RISKS FACTORS**

### **Risks Relating to India**

**51. *Our business is substantially affected by prevailing economic, political and others prevailing conditions in India.***

Substantially all of our business, assets and employees are located in India. As a result, we are highly dependent on prevailing economic conditions in India and its results of operations are significantly affected by factors influencing the Indian economy. Factors that may adversely affect the Indian economy include:

- global slowdown of the financial market and economies contributing to weakness in the Indian financial and economic environment;
- any increase in Indian interest rates or inflation;
- any exchange rate fluctuations;
- volatility in, and actual or perceived trends in trading activity on, India’s principal stock exchanges;
- changes in India’s tax, trade, fiscal or monetary policies;
- regulatory changes in the automotive sector in India;

- political instability, terrorism or military conflict in India or in countries in the region or globally, including in India's various neighbouring countries;
- occurrence of natural or man-made disasters;
- global health crises and pandemics like the Covid-19 pandemic;
- prevailing regional or global economic conditions;
- delinquent loans and low credit growth, deterioration in asset quality resulting in an adverse effect on the Indian economy;
- increased volatility of commodity prices;
- financial difficulties faced by certain financial institutions / intermediaries such as clearing agencies, banks, securities firms and exchanges;
- increase in India's trade deficit;
- downgrading of rating of India, the Indian banking sector by rating agencies; and
- other significant regulatory or economic developments in or affecting India or its automotive sector.

An adverse impact on the Indian economy due to any of the above-mentioned factors, could adversely impact our business, results of operations and financial condition.

**52. *If inflation rises in India, increased costs may result in a decline in profits.***

Inflation rates in India have been volatile in recent years, and such volatility may continue. India has experienced high inflation in the recent past. Increasing inflation in India could cause a rise in the costs of rent, wages, raw materials and other expenses. High fluctuations in inflation rates may make it more difficult for us to accurately estimate or control our costs. Any increase in inflation in India can increase our expenses, which we may not be able to adequately pass on to our clients, whether entirely or in part, and may adversely affect our business and financial condition. If we are unable to increase our revenues sufficiently to offset our increased costs due to inflation, it could have an adverse effect on our business, results of operations and financial condition. Further, the GoI has previously initiated economic measures to combat high inflation rates, and it is unclear whether these measures will remain in effect. There can be no assurance that Indian inflation levels will not worsen in the future.

**53. *Changing laws, rules and regulations and legal uncertainties, including adverse application or interpretation of corporate and tax laws, may adversely affect our business, results of operations and financial condition.***

Our business, results of operations and financial condition could be materially adversely affected by changes in the laws, rules, regulations or directions applicable to us, or the interpretations of such existing laws, rules and regulations, or the promulgation of new laws, rules and regulations. For details on the laws applicable to us, please see "*Key Regulations and Policies*" beginning on page 161.

The governmental and regulatory bodies may notify new regulations and/or policies, which may require us to obtain approvals and licenses from the government and other regulatory bodies, impose onerous requirements and conditions on our operations, in addition to those which we are undertaking currently. Any such changes and the related uncertainties with respect to the implementation of new regulations may have a material adverse effect on our business, results of operations and financial condition.

In addition, unfavourable changes in or interpretations of existing, or the promulgation of new laws, rules and regulations, including foreign investment laws governing our business, operations and investments in our Company by non-residents, could result in us being deemed to be in contravention of such laws or may require us to apply for additional approvals.

The Government of India has notified four labour codes which are yet to completely come into force as on the date of this Draft Red Herring Prospectus, namely, (i) The Code on Wages, 2019, (ii) The Industrial Relations Code, 2020, (iii) The Code on Social Security, 2020 and (iv) The Occupational Safety, Health and Working Conditions Code, 2020. Such codes will replace the existing legal framework governing rights of workers and labour relations.

There can be no assurance that the Government of India will not implement new regulations and policies requiring us to obtain approvals and licenses from the Government of India or other regulatory bodies or impose onerous requirements and conditions on our operations. We may incur increased costs and other burdens relating to compliance with such new requirements, which may also require significant management time and other resources, and any failure to comply may adversely affect our business, results of operations and financial condition. Uncertainty in the applicability, interpretation or implementation of any amendment to, or change in, governing law, regulation or policy, including by reason of an absence, or a limited body, of administrative or judicial precedent may be time-consuming as well as costly for us to resolve and may affect the viability of our current business or restrict our ability to grow our business in the future.

**54. *Natural calamities, climate change and health epidemics and pandemics such as COVID-19 could adversely affect the Indian economy and our business, results of operations and financial condition. In addition, hostilities, terrorist attacks, civil unrest and other acts of violence could adversely affect our business, results of operations and financial condition.***

India has experienced natural calamities, such as earthquakes and floods in the past. Natural calamities could have an adverse impact on the Indian economy which, in turn, could adversely affect our business, and may damage or destroy our facilities, vehicles or other assets. Any of these natural calamities could adversely affect our business, results of operations and financial condition.

A number of countries in Asia, including India, as well as countries in other parts of the world, are susceptible to contagious diseases and, for example, have had confirmed cases of the highly pathogenic H7N9, H5N1 and H1N1 strains of influenza in birds and swine. In addition, the COVID-19 pandemic, has caused a worldwide health crisis and economic downturn. Any future outbreak of health epidemics may restrict the level of business activity in affected areas, which may, in turn, adversely affect our business. See “*The COVID-19 pandemic had a material adverse effect on our business, results of operations and financial condition and the continuing impact of the COVID-19 pandemic is uncertain and still evolving, and could continue to adversely affect our business, results of operations and financial condition.*” on page 33.

Our operations including our sales units, service stations, car yards and vehicles may be damaged or disrupted as a result of natural calamities. Such events may lead to the disruption of information systems and telecommunication services for sustained periods. They also may make it difficult or impossible for employees to reach our business locations. Damage or destruction that interrupts our provision of services could adversely affect our reputation, our relationships with our customers, our senior management team’s ability to administer and supervise our business or it may cause us to incur substantial additional expenditure to repair or replace damaged parts of our dealership networks. Any of the above factors may adversely affect our business, results of operations and financial condition.

India has from time-to-time experienced instances of social, religious and civil unrest and hostilities between neighbouring countries. Present relations between India and Pakistan continue to be fragile on the issues of terrorism, armaments and Kashmir. Military activity or terrorist attacks in the future could influence the Indian economy by disrupting communications and making travel more difficult and such political tensions could create a greater perception that investments in Indian companies involve higher degrees of risk. Events of this nature in the future, as well as social and civil unrest within other countries in Asia, could influence the Indian economy and could have a material adverse effect on the market for securities of Indian companies.

**55. *Our business is affected by global economic conditions, especially in the geographies we cater to, which may have an adverse effect on our business, results of operations and financial condition.***

Our business depends substantially on global economic conditions. The Indian market and the Indian economy are influenced by economic and market conditions in other countries, particularly emerging market countries in Asia. Financial turmoil in Asia, U.S. and elsewhere in the world in recent years has affected the Indian economy. Although economic conditions are different in each country, investors’ reactions to developments in one country can have adverse effects on the securities of companies in other countries, including India. A loss of investor confidence in the financial systems of other emerging markets may cause increased volatility in Indian financial markets and, indirectly, in the Indian economy in general. Any worldwide financial instability could also have a negative impact on the Indian economy. Financial disruptions may occur again and could harm our business, results of operations and financial condition.

The global credit and equity markets have experienced substantial dislocations, liquidity disruptions and market corrections in recent years. Financial markets and the supply of credit could continue to be negatively impacted by ongoing concerns surrounding the sovereign debts and/or fiscal deficits of several countries in Europe, the possibility

of further downgrades of, or defaults on, sovereign debt, concerns about a slowdown in growth in certain economies and uncertainties regarding the stability and overall standing of the European Monetary Union.

Trade tensions between the U.S. and major trading partners, most notably China, escalated following the introduction of a series of tariff measures in both countries. Although China is the primary target of U.S. trade measures, value chain linkages mean that other emerging markets, primarily in Asia, may also be impacted. China's policy response to these trade measures also presents a degree of uncertainty. There is some evidence of China's monetary policy easing and the potential for greater fiscal spending, which could worsen existing imbalances in its economy. This could undermine efforts to address already high debt levels and increase medium-term risks. These and other related factors such as concerns over recession, inflation or deflation, energy costs, geopolitical issues, slowdown in economic growth in China and Renminbi devaluation, commodity prices and the availability and cost of credit have had a significant impact on the global credit and financial markets as a whole, including reduced liquidity, greater volatility, widening of credit spreads and a lack of price transparency in the United States, Europe and the global credit and financial markets. This and any prolonged financial crisis may have an adverse impact on the Indian economy, and in turn on our business, results of operations and financial condition and prospects.

A loss of investor confidence in the financial systems of other emerging markets may cause increased volatility in the Indian financial markets and indirectly in the Indian economy in general. Any worldwide financial instability could influence the Indian economy. In response to such developments, legislators and financial regulators in the United States, Europe and other jurisdictions, including India, have implemented several policy measures designed to add stability to the financial markets. In addition, any increase in interest rates by the United States Federal Reserve will lead to an increase in the borrowing costs in the United States which may in turn impact global borrowing as well. Furthermore, in several parts of the world, there are signs of increasing retreat from globalization of goods, services and people, as pressure for the introduction of a protectionist regime is building and such developments could adversely affect Indian exports. However, the overall impact of these and other legislative and regulatory efforts on the global financial markets is uncertain, and they may not have the intended stabilizing effects. In the event that the current adverse conditions in the global credit markets continue or if there is any significant financial disruption, this could have an adverse effect on our business, results of operations and financial condition.

Since December 2019, the ongoing outbreak of COVID-19 has affected countries globally, with the World Health Organization declaring the outbreak as a pandemic on March 12, 2020. There have been border controls, lockdowns and travel restrictions imposed by various countries, as a result of the COVID-19 outbreak. Such outbreak of an infectious disease together with the resulting restrictions on travel and/or imposition of lockdown measures have resulted in protracted volatility in domestic and international markets has resulted in a global slowdown and crisis. In particular, the COVID-19 outbreak has caused stock markets worldwide to fluctuate significantly in value and has impacted global economic activity. A number of governments have revised gross domestic product growth forecasts for 2020 and 2021 downwards in response to the economic slowdown caused by the spread of COVID-19, and it is possible that the outbreak of COVID-19 will cause a prolonged global economic crisis or recession.

If we are unable to successfully anticipate and respond to changing economic and market conditions, our business, results of operations and financial condition and prospects may be adversely affected.

**56. *The Indian tax regime is currently undergoing substantial changes which could adversely affect our business and the trading price of the Equity Shares.***

Our business, results of operations and financial condition could be adversely affected by any change in the extensive central and state tax regime in India applicable to us and our business. Tax and other levies imposed by the central and state governments in India that affect our tax liability, include central and state taxes and other levies, income tax, turnover tax, goods and service tax, stamp duty and other special taxes and surcharges, which are introduced on a temporary or permanent basis from time to time. This extensive central and state tax regime is subject to change from time to time. The final determination of our tax liability involves the interpretation of local tax laws and related regulations in each jurisdiction, as well as the significant use of estimates and assumptions regarding the scope of future operations and results achieved and the timing and nature of income earned and expenditures incurred.

For instance, the Government of India has implemented two major reforms in Indian tax laws, namely the GST, and provisions relating to general anti-avoidance rules ("GAAR"). The indirect tax regime in India has undergone a complete overhaul. The indirect taxes on goods and services, such as central excise duty, service tax, central sales tax, state value added tax, surcharge and excise have been replaced by Goods and Service Tax with effect from July 1, 2017. GAAR became effective from April 1, 2017. The tax consequences of the GAAR provisions being applied to an arrangement may result in, among others, a denial of tax benefit to us and our business. In the absence of any precedents on the subject, the application of these provisions is subjective. If the GAAR provisions are made

applicable to us, it may have an adverse tax impact on us. Further, if the tax costs associated with certain of our transactions are greater than anticipated because of a particular tax risk materializing on account of new tax regulations and policies, it could affect our profitability from such transactions.

Further, the Finance Act, 2020, has, amongst others things, notified changes and provided a number of amendments to the direct and indirect tax regime, including, without limitation, a simplified alternate direct tax regime and that dividend distribution tax (“DDT”), will not be payable in respect of dividends declared, distributed or paid by a domestic company after March 31, 2020, and accordingly, such dividends would not be exempt in the hands of the shareholders, both resident as well as non-resident and are subject to tax deduction at source. The Company may or may not grant the benefit of a tax treaty (where applicable) to a non-resident shareholder for the purposes of deducting tax at source from such dividend. Investors should consult their own tax advisors about the consequences of investing or trading in the Equity Shares.

**57. *Any adverse change in India’s sovereign credit rating by international rating agencies could adversely affect our business, results of operations, financial condition and cash flows.***

Our borrowing costs and our access to the debt capital markets depend significantly on the credit ratings of India. India’s sovereign rating had decreased from Baa2 with a “negative” outlook to Baa3 with a “negative” outlook by Moody’s and from BBB with a “stable” outlook to BBB with a “negative” outlook (Fitch) in June 2020; and from BBB “stable” to BBB “negative” by DBRS in May 2020. However, recently in October 2021, Moody’s upgraded India’s sovereign rating outlook from negative to stable. Going forward, the sovereign ratings outlook will remain dependent on whether the government is able to transition the economy into a high-growth environment, as well as exercise adequate fiscal restraint. Any adverse change in India’s credit ratings by international rating agencies may adversely impact the Indian economy and consequently our business, results of operations, financial condition and cash flows.

**58. *Significant differences exist between Ind AS and other accounting principles, such as US GAAP and IFRS, which may be material to investors’ assessments of our financial condition.***

The financial statements included in this Draft Red Herring Prospectus have been prepared in accordance with Ind AS, restated in accordance with the requirements of Section 26 of part I of the Companies Act, 2013, the SEBI ICDR Regulations and the Guidance Note on “Reports in Company Prospectus (Revised 2019)” issued by the ICAI. Ind AS differs from accounting principles with which prospective investors may be familiar, such as Indian GAAP, IFRS and U.S. GAAP. We have not attempted to quantify the impact of US GAAP or IFRS on the financial data included in this Draft Red Herring Prospectus, nor do we provide a reconciliation of our financial statements to those of US GAAP or IFRS. US GAAP and IFRS differ in significant respects from Ind AS. Accordingly, the degree to which the Ind AS financial statements, which are restated in accordance with the SEBI ICDR Regulations included in this Draft Red Herring Prospectus, will provide meaningful information is entirely dependent on the reader’s level of familiarity with Indian accounting practices. Any reliance by persons not familiar with Indian accounting practices on the financial disclosures presented in this Draft Red Herring Prospectus should be limited accordingly.

**59. *Foreign investors are subject to foreign investment restrictions under Indian laws which limit our ability to attract foreign investors, which may adversely impact the market price of our Equity Shares.***

Under the foreign exchange regulations currently in force in India, transfers of shares between non-residents and residents are freely permitted (subject to certain restrictions) if they comply with the pricing guidelines and reporting requirements specified by the RBI. If the transfer of shares, which are sought to be transferred, is not in compliance with such pricing guidelines or reporting requirements or falls under any of the exceptions referred to above, then the prior approval of the RBI will be required. Additionally, shareholders who seek to convert the Indian Rupee proceeds from a sale of shares in India into foreign currency and repatriate that foreign currency from India will require a no objection/tax clearance certificate from the income tax authority.

In addition, pursuant to the Press Note No. 3 (2020 Series), dated April 17, 2020, issued by the DPIIT, which has been incorporated as the proviso to Rule 6(a) of the FEMA Rules, investments where the beneficial owner of the Equity Shares is situated in or is a citizen of a country which shares land border with India, can only be made through the Government approval route, as prescribed in the Consolidated FDI Policy dated October 15, 2020 and the FEMA Rules. Furthermore, on April 22, 2020, the Ministry of Finance, GoI has also made similar amendment to the FEMA Rules. While the term “beneficial owner” is defined under the Prevention of Money-Laundering (Maintenance of Records) Rules, 2005 and the General Financial Rules, 2017, neither the foreign direct investment policy nor the FEMA Rules provide a definition of the term “beneficial owner”. The interpretation of “beneficial owner” and enforcement of this regulatory change involves certain uncertainties, which may have an adverse effect on our ability

to raise foreign capital. We cannot assure investors that any required approval from the RBI or any other Indian government agency can be obtained on any particular terms, or at all. For further details, please see on “*Restrictions on Foreign Ownership of Indian Securities*” on page 369.

**60. *It may not be possible for investors to enforce any judgment obtained outside India against us, the Book Running Lead Managers or any of their directors and executive officers in India respectively, except by way of a lawsuit in India.***

The enforcement of civil liabilities by overseas investors in the Equity Shares, including the ability to effect service of process and to enforce judgments obtained in courts outside of India may be adversely affected by the fact that the Company is incorporated under the laws of the Republic of India and most of its executive officers and directors reside in India. As a result, it may be difficult to enforce the service of process upon the Company and any of these persons outside of India or to enforce outside of India, judgments obtained against the Company and these persons in courts outside of India.

India has reciprocal recognition and enforcement of judgments in civil and commercial matters with only a limited number of jurisdictions, which includes, among others, the United Kingdom, Singapore, United Arab Emirates and Hong Kong. In order to be enforceable, a judgment from a jurisdiction with reciprocity must meet certain requirements of the Code of Civil Procedure, 1908. Judgments or decrees from jurisdictions, which do not have reciprocal recognition with India, cannot be executed in India. Therefore, a final judgment for the payment of money rendered by any court in a non-reciprocating territory for civil liability, whether or not predicated solely upon the general laws of the non-reciprocating territory, would not be enforceable in India. Even if an investor obtained a judgment in such a jurisdiction against us or our officers or directors, it may be required to institute a new proceeding in India and obtain a decree from an Indian court. However, the party in whose favor such final judgment is rendered may bring a new suit in a competent court in India based on a final judgment that has been obtained in a non-reciprocating territory within three years of obtaining such final judgment in the same manner as any other suit filed to enforce a civil liability in India. If, and to the extent that, an Indian court were of the opinion that fairness and good faith so required, it would, under current practice, give binding effect to the final judgment that had been rendered in the non-reciprocating territory, unless such a judgment contravenes principles of public policy in India. It is unlikely that an Indian court would award damages on the same basis or to the same extent as was awarded in a final judgment rendered by a court in another jurisdiction if the Indian court believed that the amount of damages awarded was excessive or inconsistent with Indian practice. In addition, any person seeking to enforce a foreign judgment in India is required to obtain prior approval of the RBI to repatriate any amount recovered pursuant to the execution of such a judgment.

**61. *Our business and activities may be regulated by the Competition Act, 2002 and proceedings may be enforced against us.***

The Competition Act seeks to prevent business practices that have an appreciable adverse effect on competition in the relevant market in India. Under the Competition Act, any arrangement, understanding or action in concert between enterprises, whether formal or informal, which causes or is likely to cause an appreciable adverse effect on competition in India is void and attracts substantial monetary penalties. Further, any agreement among competitors which directly or indirectly involves the determination of purchase or sale prices, limits or controls production, supply, markets, technical development, investment or provision of services, shares the market or source of production or provision of services in any manner by way of allocation of geographical area, type of goods or services or number of consumers in the relevant market or in any other similar way or directly or indirectly results in bid-rigging or collusive bidding is presumed to have an appreciable adverse effect on competition.

The Competition Act also prohibits abuse of a dominant position by any enterprise. If it is proved that the contravention committed by a company took place with the consent or connivance or is attributable to any neglect on the part of, any director, manager, secretary or other officer of such company, that person shall be also guilty of the contravention and may be punished. On March 4, 2011, the GoI notified and brought into force the combination regulation (merger control) provisions under the Competition Act with effect from June 1, 2011. These provisions require acquisitions of shares, voting rights, assets or control or mergers or amalgamations that cross the prescribed asset and turnover based thresholds to be mandatorily notified to, and pre-approved by, the Competition Commission of India, or CCI. Additionally, on May 11, 2011, the CCI issued the Competition Commission of India (Procedure in regard to the transaction of business relating to combinations) Regulations, 2011, as amended, which sets out the mechanism for implementation of the merger control regime in India.

The Competition Act aims to, among other things, prohibit all agreements and transactions, including agreements between vertical trading partners i.e., entities at different stages or levels of the production chain in different markets,



which may have an appreciable adverse effect on competition in India. Consequently, all agreements entered into by us could be within the purview of the Competition Act. We may also be subject to queries from the CCI pursuant to complaints by consumers or any third persons, which could be made without any or adequate basis given our market presence. Further, the CCI has extra-territorial powers and can investigate any agreements, abusive conduct or combination occurring outside of India if such agreement, conduct or combination has an appreciable adverse effect on competition in India. However, the effect of the provisions of the Competition Act on the agreements entered into by us cannot be predicted with certainty at this stage.

### **Risks Relating to the Equity Shares and the Offer**

**62. *Our Equity Shares have never been publicly traded, and after the Offer, the Equity Shares may experience price and volume fluctuations, and an active trading market for the Equity Shares may not develop. Further, the Offer Price may not be indicative of the market price of the Equity Shares after the Offer.***

Prior to the Offer, there has been no public market for the Equity Shares, and an active trading market on the Stock Exchanges may not develop or be sustained after the Offer. Listing and quotation does not guarantee that a market for the Equity Shares will develop, or if developed, the liquidity of such market for the Equity Shares. The Offer Price of the Equity Shares is proposed to be determined in consultation with the BRLMs through the Book-Building Process and may not be indicative of the market price of the Equity Shares at the time of commencement of trading of the Equity Shares or at any time thereafter. The market price of the Equity Shares may be subject to significant fluctuations in response to, among other factors, variations in our results of operations, market conditions specific to the industry we operate in, developments relating to India, volatility in securities markets in jurisdictions other than India, problems such as temporary closure, broker default and settlement delays experienced by the Indian Stock Exchanges, announcements by us or our competitors of significant acquisitions, strategic alliances, joint operations or capital commitments; announcements by third parties or governmental entities of significant claims or proceedings against us, variations in the growth rate of financial indicators, variations in revenue or earnings estimates by research publications, and changes in economic, legal and other regulatory factors. Consequently, the price of our Equity Shares may be volatile, and you may be unable to resell your Equity Shares at or above the Offer Price, or at all.

There has been significant volatility in the Indian stock markets in the recent past, and our Equity Share price could fluctuate significantly because of market volatility. A decrease in the market price of our Equity Shares could cause investors to lose some or all of their investment.

**63. *Currency exchange rate fluctuations may affect the value of the Equity Shares.***

The exchange rate between the Rupee and other foreign currencies, including the U.S. Dollar, the British pound sterling, the Euro, the Hong Kong Dollar, the Singapore Dollar and the Japanese Yen, has changed substantially in recent years and may fluctuate substantially in the future. Fluctuations in the exchange rate between the foreign currencies with which an investor may have purchased and Rupees may have a material adverse effect on the value of the Equity Shares and returns from the Equity Shares, independent of our operating results. Specifically, if there is a change in relative value of the Rupee to a foreign currency, each of the following values will also be affected:

- the foreign currency equivalent of the Rupee trading price of the Company's Equity Shares in India;
- the foreign currency equivalent of the proceeds that you would receive upon the sale in India of any of the Company's Equity Shares; and
- the foreign currency equivalent of cash dividends, if any, on the Company's Equity Shares, which will be paid only in Rupees.

You may be unable to convert Rupee proceeds into a foreign currency of your choice, or the rate at which any such conversion could occur could fluctuate. In addition, the Company's market valuation could be significantly harmed by a devaluation of the Rupee if investors in jurisdictions outside India analyse its value based on the relevant foreign currency equivalent of the Company's results of operations and financial condition.

**64. *We cannot assure payment of dividends on the Equity Shares in the future.***

Our Company has a formal dividend policy as on the date of this Draft Red Herring Prospectus. For details pertaining to dividend declared by us in the past, see "*Dividend Policy*" on page 201. Our ability to pay dividends in the future will depend upon our future results of operations, financial condition, cash flows, working capital requirements and capital expenditure requirements and other factors considered relevant by our directors and shareholders. Our ability to pay dividends may also be restricted under certain financing arrangements that we may enter into. We cannot

assure you that we will be able to pay dividends on the Equity Shares at any point in the future.

**65. *The determination of the Price Band is based on various factors and assumptions and the Offer Price of the Equity Shares may not be indicative of the market price of the Equity Shares after the Offer. Further, the current market price of some securities listed pursuant to certain previous issues managed by the Book Running Lead Managers is below their respective issue prices.***

There has been no public market for our Equity Shares prior to the Offer. The determination of the Price Band is based on various factors and assumptions and will be determined by our Company and the Promoter Selling Shareholders in consultation with the Book Running Lead Managers. Furthermore, the Offer Price of the Equity Shares will be determined by our Company and the Selling Shareholders in consultation with the Book Running Lead Managers through the Book Building Process. These will be based on numerous factors, including factors as described under “*Basis for the Offer Price*” beginning on page 99 and may not be indicative of the market price for the Equity Shares after the Offer. You may not be able to re-sell your Equity Shares at or above the Offer price and may as a result lose all or part of your investment.

In addition to the above, the current market price of securities listed pursuant to certain previous initial public offerings managed by the Book Running Lead Managers is below their respective issue price. For further details, see “*Other Regulatory and Statutory Disclosures – Price information of past issues handled by the BRLMs*” commencing on page 336. The factors that could affect the market price of the Equity Shares include, among others, broad market trends, financial performance and results of our Company post-listing, and other factors beyond our control. We cannot assure you that an active market will develop or sustained trading will take place in the Equity Shares or provide any assurance regarding the price at which the Equity Shares will be traded after listing.

**66. *Investors may be subject to Indian taxes arising out of income arising on the sale of and dividend on the Equity Shares.***

Under current Indian tax laws, unless specifically exempted, capital gains arising from the sale of equity shares held as investments in an Indian company are generally taxable in India. Any capital gain realized on the sale of listed equity shares on a Stock Exchange held for more than 12 months immediately preceding the date of transfer will be subject to long term capital gains in India at the specified rates depending on certain factors, such as whether the sale is undertaken on or off the Stock Exchanges, the quantum of gains and any available treaty relief. Accordingly, you may be subject to payment of long-term capital gains tax in India, in addition to payment of Securities Transaction Tax (“STT”), on the sale of any Equity Shares held for more than 12 months immediately preceding the date of transfer. STT will be levied on and collected by a domestic stock exchange on which the Equity Shares are sold.

Further, any capital gains realized on the sale of listed equity shares held for a period of 12 months or less immediately preceding the date of transfer will be subject to short term capital gains tax in India. Capital gains arising from the sale of the Equity Shares will not be chargeable to tax in India in cases where relief from such taxation in India is provided under a treaty between India and the country of which the seller is resident and the seller is entitled to avail benefits thereunder, subject to certain conditions.

Similarly, any business income realized from the transfer of Equity Shares held as trading assets is taxable at the applicable tax rates subject to any treaty relief, if applicable, to a non-resident seller. Additionally, in terms of the Finance Act, 2018, which has been notified on March 29, 2018 with effect from April 1, 2018, the tax payable by an assessee on the capital gains arising from transfer of long-term capital asset (introduced as section 112A of the Income-Tax Act, 1961) shall be calculated on such long-term capital gains at the rate of 10%, where the long-term capital gains exceed ₹100,000, subject to certain exceptions in case of resident individuals and HUFs.

Further, the Finance Act, 2019 has made various amendments in the taxation laws and has also clarified that, in the absence of a specific provision under an agreement, the liability to pay stamp duty in case of sale of securities through stock exchanges will be on the buyer, while in other cases of transfer for consideration through a depository, the onus will be on the transferor. The stamp duty for transfer of securities other than debentures, on a delivery basis is specified at 0.015% and on a non-delivery basis is specified at 0.003% of the consideration amount. These amendments have come into effect from July 1, 2020.

Additionally, the Finance Act, 2020 does not require DDT to be payable in respect of dividends declared, distributed or paid by a domestic company on or after April 1, 2020, and accordingly, such dividends would not be exempt in the hands of the shareholders, both resident as well as non-resident. The Company may or may not grant the benefit of a tax treaty (where applicable) to a non-resident shareholder for the purposes of deducting tax at source pursuant to any corporate action including dividends.

Our Company cannot predict whether any tax laws or other regulations impacting it will be enacted or predict the nature and impact of any such laws or regulations or whether, if at all, any laws or regulations would have a material adverse effect on our business, results of operations and financial condition.

**67. *QIBs and Non-Institutional Investors are not permitted to withdraw or lower their Bids (in terms of quantity of Equity Shares or the Bid Amount) at any stage after submitting a Bid, and Retail Individual Investors are not permitted to withdraw their Bids after Bid/Offer Closing Date.***

Pursuant to the SEBI ICDR Regulations, QIBs and Non-Institutional Investors are required to pay the Bid Amount on submission of the Bid and are not permitted to withdraw or lower their Bids (in terms of quantity of Equity Shares or the Bid Amount) at any stage after submitting a Bid. Therefore, QIBs and Non-Institutional Bidders would not be able to withdraw or lower their Bids, notwithstanding adverse changes in international or national monetary policy, financial, political or economic conditions, our business, results of operations or financial condition, or otherwise, between the dates of the submission of their Bids and the Allotment.

Retail Individual Investors and Eligible Employees Bidding under the Employee Reservation Portion can revise their Bids during the Bid/Offer Period and withdraw their Bids until Bid/Offer Closing Date. While our Company is required to complete all necessary formalities for listing and commencement of trading of the Equity Shares on all Stock Exchanges where such Equity Shares are proposed to be listed including Allotment pursuant to the Offer within six Working Days from the Bid/Offer Closing Date, events affecting the Bidders' decision to invest in the Equity Shares, including material adverse changes in international or national monetary policy, financial, political or economic conditions, our business, results of operations or financial condition may arise between the date of submission of the Bid and Allotment. Our Company may complete the Allotment of the Equity Shares even if such events occur, and such events limit the Bidders' ability to sell the Equity Shares Allotted pursuant to the Offer or cause the trading price of the Equity Shares to decline on listing.

**68. *The Offer Price of the Equity Shares may not be indicative of the market price of the Equity Shares after the Offer.***

The Offer Price will be determined by the Book Building Process and may not be indicative of prices that will prevail in the open market following the Offer. The market price of the Equity Shares may be influenced by many factors, some of which are beyond our control, including:

- the failure of security analysts to cover the Equity Shares after this Offer, or changes in the estimates of our performance by analysts;
- the activities of competitors and suppliers;
- future sales of the Equity Shares by our Company or our shareholders;
- investor perception of us and the industry in which we operate;
- our quarterly or annual earnings or those of our competitors;
- developments affecting fiscal, industrial or environmental regulations;
- the public's reaction to our press releases and adverse media reports;
- our financial condition, results of operations and cash flows;
- the history of and prospects for our business;
- an assessment of our management, our past and present operations and the prospects for as well as timing of our future revenues and cost structures;
- the valuation of publicly traded companies that are engaged in business activities similar to ours;
- quarterly variations in our results of operations;
- results of operations that vary from the expectations of securities analysts and investors;
- results of operations that vary from those of our competitors;

- changes in expectations as to our future financial condition, including financial estimates by research analysts and investors;
- announcements of significant claims or proceedings against us;
- new laws and government regulations that directly or indirectly affect our business;
- additions or departures of Key Managerial Personnel;
- changes in interest rates;
- fluctuations in stock market prices and volume; and
- general economic conditions.

As a result of these factors, investors may not be able to resell their Equity Shares at or above the initial public offering price. In addition, the stock market often experiences price and volume fluctuations that are unrelated or disproportionate to the operating performance of a particular company. These broad market fluctuations and industry factors may materially reduce the market price of the Equity Shares, regardless of our Company's performance. There can be no assurance that the investor will be able to resell their Equity Shares at or above the Offer Price.

**69.  *Holders of Equity Shares could be restricted in their ability to exercise pre-emptive rights under Indian law and could thereby suffer future dilution of their ownership position.***

Under the Companies Act, a company having share capital and incorporated in India must offer holders of its Equity Shares pre-emptive rights to subscribe and pay for a proportionate number of Equity Shares to maintain their existing ownership percentages prior to the issuance of any new equity shares, unless the pre-emptive rights have been waived by the adoption of a special resolution by holders of three-fourths of the Equity Shares who have voted on such resolution. However, if the laws of the jurisdiction that investors are in does not permit the exercise of such pre-emptive rights without us filing an offering document or registration statement with the applicable authority in such jurisdiction, the investors will be unable to exercise such pre-emptive rights unless we make such a filing. If our Company elects not to file a registration statement, the new securities may be issued to a custodian, who may sell the securities for the investor's benefit. The value the custodian receives on the sale of such securities and the related transaction costs cannot be predicted. To the extent that the holders are unable to exercise pre-emptive rights granted in respect of the Equity Shares, they may suffer future dilution of their ownership position and their proportional interests in our Company would be reduced.

**70.  *There is no guarantee that our Equity Shares will be listed on the Stock Exchanges in a timely manner or at all and if they are listed you may not be able to immediately sell any of the Equity Shares you subscribe to in this Offer on the stock exchanges.***

In accordance with Indian law, certain actions must be completed before the Equity Shares can be listed and trading in the Equity Shares can commence. There can be no guarantee that these actions will be completed in a timely manner or at all and as a result our Equity Shares may not be listed on the Stock Exchanges in a timely manner or at all.

In accordance with the current regulations and circulars issued by SEBI, the Equity Shares are required to be listed on the Stock Exchanges within such time as mandated under UPI Circulars, subject to any change in the prescribed timeline in this regard. However, we cannot assure you that the trading in the Equity Shares will commence in a timely manner, in accordance with timelines prescribed under the UPI Circulars, or at all. Investors can start trading the Equity Shares Allotted to them only after they have been credited to an investors' demat account, are listed and permitted to trade. Since the Equity Shares will be traded on the Stock Exchanges, investors will be subject to market risk from the date they pay for the Equity Shares to the date when Equity Shares Allotted are listed and permitted to trade. Investors' book entry, or 'demat' accounts with depository participants in India, are expected to be credited with the Equity Shares within one working day of the date on which the Basis of Allotment is approved by the Stock Exchanges. The Allotment of Equity Shares in this Offer and such Equity Shares are expected to be credited to the demat accounts of the Investors within approximately six working days from the Bid Closing Date (or such other period as prescribed under applicable laws). In addition, upon receipt of listing and trading approval from the Stock Exchanges, trading of Equity Shares is expected to commence within six Working Days from Bid/ Offer Closing Date (or such other period as prescribed under applicable laws).

There could be failure or delays in listing the Equity Shares on the Stock Exchanges. Any failure or delay in obtaining the approval or otherwise any delay in commencing trading in the Equity Shares would restrict investors' ability to dispose of their Equity Shares. There can be no assurance that the Equity Shares will be credited to investors' demat accounts, or that trading in the Equity Shares will commence, within the time periods specified in this risk factor. We could also be required to pay interest at the applicable rates if allotment is not made, refund orders are not dispatched or demat credits are not made to investors within the prescribed time periods.

***71. Any future issuance of Equity Shares or convertible securities or other equity linked securities by our Company may dilute holders' shareholding and sales of the Equity Shares by our major shareholders may adversely affect the trading price of the Equity Shares.***

Any future equity issuances by us, including a primary offering, may lead to the dilution of investors' shareholding in us. Any disposal of Equity Shares by our major shareholders or the perception that such issuance or sales may occur, including to comply with the minimum public shareholding norms applicable to listed companies in India may adversely affect the trading price of the Equity Shares, which may lead to other adverse consequences including difficulty in raising capital through offering of the Equity Shares or incurring additional debt. There can be no assurance that we will not issue further Equity Shares or that the shareholders will not dispose of the Equity Shares. Any future issuances could also dilute the value of your investment in the Equity Shares. In addition, any perception by investors that such issuances or sales might occur may also affect the market price of the Equity Shares.

***72. A third party could be prevented from acquiring control of our Company because of anti-takeover provisions under Indian law.***

There are provisions in Indian law that may delay, deter or prevent a future takeover or change in control of our Company, even if a change in control would result in the purchase of your Equity Shares at a premium to the market price or would otherwise be beneficial to you. Such provisions may discourage or prevent certain types of transactions involving actual or threatened change in control of our Company. Under the SEBI Takeover Regulations, an acquirer has been defined as any person who, directly or indirectly, acquires or agrees to acquire shares or voting rights or control over a company, whether individually or acting in concert with others. Although these provisions have been formulated to ensure that interests of investors/shareholders are protected, these provisions may also discourage a third party from attempting to take control of our Company. Consequently, even if a potential takeover of our Company would result in the purchase of the Equity Shares at a premium to their market price or would otherwise be beneficial to its stakeholders, it is possible that such a takeover would not be attempted or consummated because of the SEBI Takeover Regulations.

## SECTION III – INTRODUCTION

### THE OFFER

The following table summarizes details of the Offer:

The Offer comprises:	Up to [●] Equity Shares aggregating up to ₹ 7,620.00 million
Fresh Issue <sup>(1) ^</sup>	Up to [●] Equity Shares aggregating up to ₹ 1,500.00 million
Offer for Sale <sup>(2)</sup>	Up to [●] Equity Shares, aggregating up to ₹ 6,120.00 million
<i>Of which:</i>	
Employee Reservation Portion <sup>(3)</sup>	Up to [●] Equity Shares aggregating up to ₹ [●] million
Net Offer	Up to [●] Equity Shares aggregating up to ₹ [●] million
A) QIB Portion <sup>(4)(5)</sup>	Not more than [●] Equity Shares
<i>of which:</i>	
(i) Anchor Investor Portion	Up to [●] Equity Shares
(ii) Net QIB Portion (assuming Anchor Investor Portion is fully subscribed)	[●] Equity Shares
<i>of which:</i>	
(a) Mutual Fund Portion	[●] Equity Shares
(b) Balance of the Net QIB Portion for all QIBs including Mutual Funds	[●] Equity Shares
B) Non-Institutional Portion	Not less than [●] Equity Shares
C) Retail Portion <sup>(5)</sup>	Not less than [●] Equity Shares
<b>Pre-Offer and post-Offer Equity Shares</b>	
Equity Shares outstanding prior to the Offer (as at the date of this Draft Red Herring Prospectus)	36,625,620 Equity Shares
Equity Shares outstanding after the Offer	[●] Equity Shares
<b>Use of Net Proceeds</b>	See “ <i>Objects of the Offer</i> ” on page 89. Our Company will not receive any proceeds from the Offer for Sale.

<sup>^</sup> Our Company and the Selling Shareholders, in consultation with the BRLMs, may consider the Pre-IPO Placement aggregating up to ₹ 300.00 million. If the Pre-IPO Placement is completed, the size of the Fresh Issue will be reduced to the extent of such Pre-IPO Placement, subject to the Offer constituting at least [●]% of the post-Offer paid up Equity Share capital of our Company.

<sup>(1)</sup> The Offer has been authorized by a resolution of our Board dated January 11, 2022 and the Fresh Issue has been approved by a special resolution dated January 11, 2022 passed by our Shareholders.

<sup>(2)</sup> The Offer for Sale has been authorised by the Selling Shareholders as follows:

Selling Shareholder	Offered Shares in (₹ million)	Date of authorization letter/ board resolution	Date of consent letter
TPG Growth	Up to ₹ 4,000.00 million	December 15, 2021	January 18, 2022
Sanjay Karsandas Thakker HUF	Up to ₹ 620.00 million	-	January 11, 2022
Aastha Limited	Up to ₹ 1,200.00 million	January 11, 2022	January 11, 2022
Garima Misra	Up to ₹ 300.00 million	-	January 11, 2022

The Equity Shares being offered by the Selling Shareholders are eligible for being offered for sale as part of the Offer for Sale in terms of the SEBI ICDR Regulations. Each Selling Shareholder, severally and not jointly, confirms that it has authorized the sale of its portion of the Offered Shares in the Offer for Sale.

<sup>(3)</sup> In the event of under-subscription in the Employee Reservation Portion, the unsubscribed portion will be available for allocation and Allotment, proportionately to all Eligible Employees who have Bid in excess of ₹ 200,000, subject to the maximum value of Allotment made to such Eligible Employee not exceeding ₹500,000. The unsubscribed portion, if any, in the Employee Reservation Portion (after allocation of up to ₹ 500,000, as applicable), shall be added to the Net Offer. For further details, see “Offer Structure” on page 347.

- (4) *Our Company and the Selling Shareholders may, in consultation with the BRLMs, allocate up to 60% of the QIB Portion to Anchor Investors on a discretionary basis. The QIB Portion will accordingly be reduced for the Equity Shares allocated to Anchor Investors. One-third of the Anchor Investor Portion shall be reserved for domestic Mutual Funds, subject to valid Bids being received from domestic Mutual Funds at or above the Anchor Investor Allocation Price. In the event of under-subscription in the Anchor Investor Portion, the remaining Equity Shares shall be added to the Net QIB Portion. 5% of the Net QIB Portion shall be available for allocation on a proportionate basis to Mutual Funds only, and the remainder of the Net QIB Portion shall be available for allocation on a proportionate basis to all QIB Bidders, including Mutual Funds, subject to valid Bids being received at or above the Offer Price. In the event the aggregate demand from Mutual Funds is less than as specified above, the balance Equity Shares available for Allotment in the Mutual Fund Portion will be added to the Net QIB Portion and allocated proportionately to the QIB Bidders in proportion to their Bids. For details, see “Offer Procedure” on page 351.*
- (5) *Subject to valid Bids being received at or above the Offer Price, under-subscription, if any, in any category except the QIB Portion, would be allowed to be met with spill over from any other category or combination of categories, as applicable, at the discretion of our Company and the Selling Shareholders, in consultation with the BRLMs and the Designated Stock Exchange, subject to applicable laws. In the event of under-subscription in the Offer, the Equity Shares will be allotted in the following order: (i) such number of Equity Shares will first be Allotted by our Company such that 90% of the Fresh Issue portion is subscribed; (ii) upon completion of (i), all the Equity Shares held by the Investor Selling Shareholder and offered for sale in the Offer for Sale will be Allotted; (iii) upon completion of (i) and (ii) all Equity Shares offered by the Individual Selling Shareholder and the Other Selling Shareholders in proportion to the Offered Shares being offered by each Selling Shareholder will be Allotted; and (iv) once Equity Shares have been Allotted as per (i), (ii) and (iii) above, such number of Equity Shares will be Allotted by our Company towards the balance 10% of the Fresh Issue portion. See “Terms of the Offer – Minimum Subscription” beginning on page 345.*
- (6) *Allocation to Bidders in all categories, except Anchor Investors, if any and Retail Individual Investors, shall be made on a proportionate basis subject to valid Bids received at or above the Offer Price. The allocation to each Retail Individual Investor shall not be less than the minimum Bid Lot, subject to availability of Equity Shares in the Retail Portion and the remaining available Equity Shares, if any, shall be allocated on a proportionate basis. Allocation to Anchor Investors shall be on a discretionary basis. For details, see “Offer Procedure” on page 351.*

For further details, including in relation to grounds for rejection of Bids, refer to “Offer Structure” and “Offer Procedure” on page 347 and 351, respectively. For details of the terms of the Offer, see “Terms of the Offer” on page 341.

## **SUMMARY FINANCIAL INFORMATION**

The following table set forth summary financial information derived from the Restated Consolidated Financial Information. The summary financial information presented below should be read in conjunction with “*Financial Information*” and “*Management’s Discussion and Analysis of Financial Position and Results of Operations*” on pages 202 and 272, respectively.

*[The remainder of this page has intentionally been left blank]*



## SUMMARY OF RESTATED CONSOLIDATED STATEMENT OF ASSETS AND LIABILITIES

(₹ in million, except per share data)

Particulars	As at			
	September 30, 2021	March 31, 2021	March 31, 2020	March 31, 2019
<b>ASSETS</b>				
<b>Non-current assets</b>				
Property, plant and equipment	1,969.52	1,901.03	2,114.45	2,270.75
Right-of-use assets	1,058.04	1,095.51	1,310.99	1,452.62
Capital Work-in-Progress	24.36	6.76	0.33	-
Goodwill	234.01	231.67	231.67	134.74
Other intangible assets	40.03	31.74	44.60	56.99
Intangible assets under development	9.07	8.96	6.41	4.38
Financial assets				
Investments	157.50	129.67	79.99	-
Loans	-	-	308.50	15.29
Other financial assets	166.66	125.52	148.03	168.45
Current tax assets	12.29	27.38	55.60	48.87
Deferred tax assets	117.21	56.73	49.03	88.65
Other non-current assets	21.63	21.31	6.41	4.63
<b>Total non-current assets</b>	<b>3,810.32</b>	<b>3,636.28</b>	<b>4,356.01</b>	<b>4,245.37</b>
<b>Current assets</b>				
Inventories	3,442.89	2,888.22	2,257.63	3,397.96
Financial assets				
Investments	-	-	22.50	-
Trade receivables	701.91	557.84	236.45	783.47
Cash and cash equivalents	586.95	150.34	277.01	322.44
Other balances with banks	119.25	76.86	56.26	43.24
Loans	396.38	563.41	148.61	64.87
Other financial assets	238.64	276.02	289.08	433.25
Current tax assets (net)	46.42	14.22	31.15	11.95
Other current assets	644.11	715.76	642.97	777.78
<b>Total current assets</b>	<b>6,176.55</b>	<b>5,242.67</b>	<b>3,961.66</b>	<b>5,834.96</b>
<b>Total assets</b>	<b>9,986.87</b>	<b>8,878.95</b>	<b>8,317.67</b>	<b>10,080.33</b>
<b>EQUITY AND LIABILITIES</b>				
<b>EQUITY</b>				
Equity share capital	183.13	183.13	183.13	183.13
Other equity	1,902.36	1,634.62	1,508.12	1,696.51
<b>Total equity attributable to equity holders of the parent</b>	<b>2,085.49</b>	<b>1,817.75</b>	<b>1,691.25</b>	<b>1,879.64</b>
Non-controlling interests	7.68	6.01	7.84	9.92
<b>Total equity</b>	<b>2,093.17</b>	<b>1,823.76</b>	<b>1,699.09</b>	<b>1,889.56</b>
<b>LIABILITIES</b>				
<b>Non-current liabilities</b>				
Financial liabilities				
Borrowings	466.88	487.65	525.68	456.21
Lease liabilities	950.25	1,028.35	1,233.23	1,284.47
Deferred tax liabilities	12.12	8.65	13.99	23.28
Other non-current liabilities	66.07	72.43	46.30	46.69
<b>Total non-current liabilities</b>	<b>1,495.32</b>	<b>1,597.08</b>	<b>1,819.20</b>	<b>1,810.65</b>
<b>Current liabilities</b>				
Financial liabilities				
Borrowings	2,369.29	1,603.26	1,274.49	2,051.58
Vehicle floor plan payable	1,252.26	1,183.50	1,778.91	2,279.97

Particulars	As at			
	September 30, 2021	March 31, 2021	March 31, 2020	March 31, 2019
Lease liabilities	343.53	331.34	238.28	301.58
Trade payables				
(i) total outstanding dues of micro enterprises and small enterprises	19.41	15.08	14.20	9.91
(ii) total outstanding dues of creditors other than micro enterprises and small enterprises	1,038.37	987.31	542.53	692.69
Other financial liabilities	57.25	49.76	70.18	104.12
Other current liabilities	1,309.80	1,225.17	873.44	939.73
Current tax liabilities (net)	8.47	62.69	7.35	0.54
<b>Total current liabilities</b>	<b>6,398.38</b>	<b>5,458.11</b>	<b>4,799.38</b>	<b>6,380.12</b>
<b>Total liabilities</b>	<b>7,893.70</b>	<b>7,055.19</b>	<b>6,618.58</b>	<b>8,190.77</b>
<b>Total equity and liabilities</b>	<b>9,986.87</b>	<b>8,878.95</b>	<b>8,317.67</b>	<b>10,080.33</b>

**SUMMARY OF RESTATED CONSOLIDATED STATEMENT OF PROFIT AND LOSS**

*(₹ in million, except per share data)*

Particulars	For the six months period ended September 30, 2021	For the year ended		
		March 31, 2021	March 31, 2020	March 31, 2019
<b>Income</b>				
Revenue from operations	14,128.42	19,561.04	22,186.14	28,265.18
Other income	69.51	102.39	103.19	80.98
<b>Total Income</b>	<b>14,197.93</b>	<b>19,663.43</b>	<b>22,289.33</b>	<b>28,346.16</b>
<b>Expenses</b>				
Purchase of cars, spares and others	12,768.26	17,104.29	17,808.48	24,776.35
Changes in inventories of stock-in-trade	(554.67)	(630.59)	1,140.33	(151.01)
Employee benefits expense	674.60	1,076.66	1,367.39	1,522.63
Finance costs	182.21	378.05	448.85	527.63
Depreciation and amortisation expense	310.98	624.77	629.52	534.16
Other expenses	533.22	912.44	1,141.18	1,311.92
<b>Total expenses</b>	<b>13,914.60</b>	<b>19,465.62</b>	<b>22,535.75</b>	<b>28,521.68</b>
<b>Restated Profit/(Loss) before tax</b>	<b>283.33</b>	<b>197.81</b>	<b>(246.42)</b>	<b>(175.52)</b>
<b>Tax expense</b>				
Current tax	61.45	103.08	12.81	55.73
Deferred tax	(57.59)	(16.75)	30.16	13.03
<b>Total tax expense</b>	<b>3.86</b>	<b>86.33</b>	<b>42.97</b>	<b>68.76</b>
<b>Restated Profit/(Loss) for the period / year</b>	<b>279.47</b>	<b>111.48</b>	<b>(289.39)</b>	<b>(244.28)</b>
<b>Other comprehensive income</b>				
<b>Items that will not be subsequently reclassified to profit and loss</b>				
Change in fair value of investment carried at fair value through other comprehensive income	2.53	16.89	-	-
Remeasurement gain/(loss) of defined benefit plans	1.63	-	-	-
Less: Income tax impact on above	0.99	3.71	-	-
<b>Restated Other comprehensive income for the period/year</b>	<b>3.17</b>	<b>13.18</b>	<b>-</b>	<b>-</b>
<b>Restated Total Comprehensive Income / (loss) for the period / year</b>	<b>282.64</b>	<b>124.66</b>	<b>(289.39)</b>	<b>(244.28)</b>
<b>Restated Profit/(Loss) for the period / year attributable to:</b>				
Owners of the Company	277.80	113.31	(287.31)	(252.55)
Non-controlling interests	1.67	(1.83)	(2.08)	8.27
	<b>279.47</b>	<b>111.48</b>	<b>(289.39)</b>	<b>(244.28)</b>
<b>Restated Other Comprehensive income for the period / year attributable to:</b>				
Owners of the company	3.17	13.18	-	-
Non-controlling interests	-	-	-	-
	<b>3.17</b>	<b>13.18</b>	<b>-</b>	<b>-</b>
<b>Restated Total Comprehensive income /(loss) for the period / year attributable to:</b>				
Owners of the company	280.97	126.49	(287.31)	(252.55)
Non-controlling interests	1.67	(1.83)	(2.08)	8.27
	<b>282.64</b>	<b>124.66</b>	<b>(289.39)</b>	<b>(244.28)</b>
<b>Restated Earnings/(loss) per Equity Share (face value of ₹ 5 each)</b>				
Basic (In ₹)	7.58	3.09	(7.84)	(7.01)
Diluted (In ₹)	7.40	3.05	(7.84)	(7.00)

## SUMMARY OF RESTATED CONSOLIDATED STATEMENT OF CASH FLOWS

(₹ in million, except per share data)

Particulars	For the six months period ended September 30, 2021	For the year ended		
		March 31, 2021	March 31, 2020	March 31, 2019
<b>CASH FLOWS FROM OPERATING ACTIVITIES</b>				
Restated Profit/(Loss) before tax	283.33	197.81	(246.42)	(175.52)
<b>Adjustments for:</b>				
Depreciation and amortisation expense	310.99	624.77	629.52	534.16
Finance costs	182.21	378.05	448.85	527.63
Interest income	(25.58)	(50.62)	(35.58)	(15.67)
Sundry balances written back (Net)	(11.96)	(31.49)	(39.20)	(28.32)
Excess provision written back	(5.33)	(0.37)	(3.18)	-
Bad debts written off	1.44	5.05	9.30	4.66
Provision for doubtful debts	0.74	1.70	0.64	21.04
Share based payment expense	0.51	0.01	1.22	54.29
Loss on sale of property, plant and equipment (Net)	5.02	39.97	39.99	12.54
Gain on termination of lease	(11.39)	-	-	-
Gain on sale of current investments	-	(0.48)	-	-
<b>Operating Profit Before Working Capital Changes</b>	<b>729.98</b>	<b>1,164.40</b>	<b>805.14</b>	<b>934.81</b>
<b>Adjustments for:</b>				
(Increase)/Decrease in Inventories	(554.67)	(630.59)	1,140.34	(151.01)
(Increase)/Decrease in trade receivables	(139.92)	(326.77)	540.35	(195.11)
(Increase)/Decrease in financial assets	(7.17)	37.02	180.16	2.22
Decrease/(Increase) in other assets	71.45	(72.81)	134.88	14.28
Increase/(Decrease) in vehicle floor plan	68.76	(595.41)	(501.06)	23.86
Increase/(Decrease) in trade payables	67.37	478.61	(106.68)	135.62
Increase/(Decrease) in other liabilities	79.90	375.78	(64.60)	(72.14)
<b>Cash Generated From Operations</b>	<b>315.70</b>	<b>430.23</b>	<b>2,128.53</b>	<b>692.53</b>
Direct taxes paid (net)	(133.18)	(2.59)	(31.93)	(143.68)
<b>Net Cash generated from Operating Activities</b>	<b>182.52</b>	<b>427.64</b>	<b>2,096.60</b>	<b>548.85</b>
<b>CASH FLOWS FROM INVESTING ACTIVITIES</b>				
Purchase of property, plant and equipment (Including Capital Work-in-progress, other intangible assets, capital advances and capital creditors)	(246.58)	(148.03)	(224.13)	(359.23)
Proceeds from sale of property, plant and equipment	11.47	19.59	41.32	30.64
Purchase of non-current investments	(25.30)	(25.29)	(79.99)	-
Purchase of current investments	-	-	(22.50)	-
Redemption of current investments	-	22.98	-	-
Advance for purchase of non-current investments	-	-	(7.50)	-
Inter-corporate deposits (Net)	167.22	(110.74)	(379.17)	(55.26)
Deposits with bank	(42.40)	(20.60)	(13.02)	(1.91)
Interest received	24.30	41.81	25.86	6.38
<b>Net Cash flows used in Investing Activities</b>	<b>(111.29)</b>	<b>(220.28)</b>	<b>(659.13)</b>	<b>(379.38)</b>
<b>CASH FLOWS FROM FINANCING ACTIVITIES</b>				
Dividend paid	(13.74)	-	-	(15.77)
Dividend tax paid	-	-	-	(3.21)
Finance costs paid	(180.63)	(382.85)	(457.62)	(530.41)
Proceeds from long-term borrowings	50.00	278.89	437.43	470.90
Repayment of long-term borrowings	(17.72)	(309.61)	(383.44)	(312.46)
Proceeds from short-term borrowings	5.74	-	-	-
Repayment of short-term borrowings	(21.51)	-	-	-
(Repayment of)/ Proceeds from short-term borrowings (Net) (maturity period less than 3 months)	728.75	321.47	(761.61)	359.09
Repayment of lease liabilities	(185.51)	(241.93)	(317.66)	(243.77)
<b>Net Cash flows generated from /(Used In) financing activities</b>	<b>365.38</b>	<b>(334.03)</b>	<b>(1,482.90)</b>	<b>(275.63)</b>

Particulars	For the six months period ended September 30, 2021	For the year ended		
		March 31, 2021	March 31, 2020	March 31, 2019
<b>Net Increase /(Decrease) in Cash and Cash equivalents</b>	<b>436.61</b>	<b>(126.67)</b>	<b>(45.43)</b>	<b>(106.16)</b>
CASH AND CASH EQUIVALENTS AT THE BEGINNING OF THE YEAR	150.34	277.01	322.44	428.60
<b>CASH AND CASH EQUIVALENTS AT THE END OF THE YEAR/PERIOD</b>	<b>586.95</b>	<b>150.34</b>	<b>277.01</b>	<b>322.44</b>

## GENERAL INFORMATION

### Registered Office

The address and certain other details of our Registered Office is as follows:

#### Landmark Cars Limited

Landmark House, Opp. AEC  
S.G. Highway, Thaltej  
Near Gurudwara  
Ahmedabad 380 059, Gujarat, India  
**Telephone:** +91 79 6618 5555  
**Website:** www.grouplandmark.in

For details of change in the registered office of our Company, see “*History and Certain Corporate Matters – Changes in our Registered Office*” on page 166.

### Corporate office of our Company

#### Landmark Cars Limited

Unit No. 201 to 203, Landmark, 2<sup>nd</sup> Floor  
G. M. Bhosale Marg, Worli  
Mumbai 400 018, Maharashtra, India

### Company Registration Number and Corporate Identity Number

The registration number and CIN of our Company are as follows:

- a. Registration number: 058553
- b. Corporate identity number: U50100GJ2006PLC058553

### The Registrar of Companies

Our Company is registered with the Registrar of Companies, Gujarat, Dadra & Nagar Haveli at Ahmedabad which is situated at the following address:

ROC Bhavan  
Opposite Rupal Park Society  
Behind Ankur Bus Stop, Naranpura  
Ahmedabad 380 013, Gujarat, India

### Board of Directors

The following table sets out brief details of our Board as on the date of this Draft Red Herring Prospectus:

Name	Designation	DIN	Address
Sanjay Karsandas Thakker	Chairman and Executive Director	00156093	10, Laxmi Nivas, Near Gamdevi Police Station 22, Kashibai Navrange Marg, Gamdevi Grant Road S.O, Mumbai 400 007, Maharashtra
Aryaman Sanjay Thakker	Executive Director	07625409	10, Laxmi Nivas, Near Gamdevi Police Station 22, Kashibai Navrange Marg, Gamdevi Grant Road S.O, Mumbai 400 007, Maharashtra
Paras Somani	Executive Whole-Time Director	02742256	702, Eminence-14, Zydus Hospital Road, Near Baghban Party Plot, Opposite Thaltej Fire Station, Thaltej, Ahmedabad 380 059, Gujarat
Akshay Tanna	Nominee Director of TPG Growth	02967021	A/72, Darshan Apartments, Mount Pleasant Road, Malabar Hill, Near Chief Minister’s Bungalow, Mumbai 400 006, Maharashtra
Manish Balkishan Chokhani	Independent Director	00204011	161, Silver Arch, 66, L Jagmohandas Marg, Near Petit Hall Compound, Nepean Sea Road, Malabar

Name	Designation	DIN	Address
			Hill, Mumbai 400 006, Maharashtra
Gautam Yogendra Trivedi	Independent Director	02647162	7 <sup>th</sup> Floor, Mistry Manor, 62-A Nepean Sea Road, Near Priyadarshini Park, Malabar Hill, Mumbai 400 006, Maharashtra
Sucheta Nilesh Shah	Independent Director	00322403	90/2, Neeta Building, G Road, Marine Drive, Kalbadevi, Mumbai 400 002, Maharashtra
Ramakant Sharma	Independent Director	02318054	B404, Knightsbridge Apartments, Brookefields CMR IT College, Kundalahalli, Bangalore North, Bangalore 560 037, Marathahalli Colony, Karnataka

For further details of our Board of Directors, see “*Our Management*” on page 178.

#### Company Secretary and Compliance Officer

Amol Arvind Raje is the Company Secretary and Compliance Officer of our Company. His contact details are as follows:

##### Amol Arvind Raje

Landmark Cars Limited  
Plot No. 275/1, Ghodbunder Road  
Patlipada, Thane (West)  
Thane 400 607, Maharashtra, India  
**Telephone:** +91 22 6271 9040  
**E-mail:** companysecretary@landmarkindia.net

#### Registrar to the Offer

##### Link Intime India Private Limited

C-101, 1<sup>st</sup> Floor, 247 Park  
L.B.S. Marg, Vikhroli (West)  
Mumbai 400 083, Maharashtra, India  
**Telephone:** +91 22 4918 6200  
**Email:** landmark.ipo@linkintime.co.in  
**Investor grievance e-mail:** landmark.ipo@linkintime.co.in  
**Website:** www.linkintime.co.in  
**Contact person:** Shanti Gopalkrishnan  
**SEBI registration number:** INR000004058

#### Book Running Lead Managers

##### Axis Capital Limited

1<sup>st</sup> Floor, Axis House  
C-2, Wadia International Centre  
Pandurang Budhkar Marg, Worli  
Mumbai 400 025, Maharashtra, India  
**Telephone:** +91 22 4325 2183  
**Email:** landmark.ipo@axiscap.in  
**Investor grievance e-mail:** complaints@axiscap.in  
**Website:** www.axiscapital.co.in  
**Contact person:** Pratik Pednekar  
**SEBI registration number:** INM000012029

##### ICICI Securities Limited

ICICI Venture House,  
Appasaheb Marathe Marg,  
Prabhadevi,  
Mumbai 400 025, Maharashtra, India  
**Telephone:** +91 22 6807 7100  
**E-mail:** landmark.ipo@icicisecurities.com  
**Investor grievance e-mail:** customercare@icicisecurities.com  
**Website:** www.icicisecurities.com  
**Contact person:** Monank Mehta  
**SEBI registration number:** MB/INM000011336

#### Syndicate Members

[•]

## Statement of inter-se allocation of responsibilities among the Book Running Lead Managers

The responsibilities and coordination by the BRLMs for various activities in the Offer are as follows:

Sr. No.	Activity	Responsibility	Co-ordination
1.	Capital structuring with the relative components and formalities such as composition of debt and equity, type of instruments, and positioning strategy	Axis and ISEC	Axis
2.	Due diligence of Company including its operations / management / business plans / legal etc., Drafting and design of Draft Red Herring Prospectus, Red Herring Prospectus and Prospectus. Ensure compliance and completion of prescribed formalities with the Stock Exchanges, SEBI and RoC including finalisation of RHP, Prospectus, Offer Agreement, Syndicate and Underwriting Agreements and RoC filing	Axis and ISEC	Axis
3.	Drafting and approval of all statutory advertisements	Axis and ISEC	Axis
4.	Drafting and approval of all publicity material other than statutory advertisements as mentioned in point 3 above, including corporate advertising and brochures.	Axis and ISEC	ISEC
5.	Appointment of intermediaries (including coordination of all agreements) and filing of media compliance report with SEBI	Axis and ISEC	ISEC
6.	Preparation of road show presentation and FAQs for the road show team	Axis and ISEC	Axis
7.	International institutional marketing of the Offer, which will cover, inter alia: <ul style="list-style-type: none"> <li>• Institutional marketing strategy</li> <li>• Finalising the list and division of international investors for one-to-one meetings</li> <li>• Finalising international road show and investor meeting schedules</li> </ul>	Axis and ISEC	Axis
8.	Domestic institutional marketing of the Offer, which will cover, inter alia: <ul style="list-style-type: none"> <li>• Finalising the list and division of domestic investors for one-to-one meetings</li> <li>• Finalising domestic road show and investor meeting schedules</li> </ul>	Axis and ISEC	ISEC
9.	Conduct non-institutional marketing of the Offer	Axis and ISEC	ISEC
10.	Conduct retail marketing of the Offer, which will cover, inter-alia: <ul style="list-style-type: none"> <li>• Finalising media, marketing, public relations strategy and publicity budget</li> <li>• Finalising collection centres</li> <li>• Finalising centres for holding conferences for brokers etc.</li> <li>• Follow-up on distribution of publicity and Offer material including form, RHP/Prospectus and deciding on the quantum of the Offer material</li> </ul>	Axis and ISEC	ISEC
11.	Coordination with Stock Exchanges for book building software, bidding terminals and mock trading	Axis and ISEC	ISEC
12.	Deposit of 1% security deposit with the designated stock exchange	Axis and ISEC	Axis
13.	Managing the book and finalization of pricing in consultation with Company and Selling Shareholders	Axis and ISEC	ISEC
14.	Post-Offer activities – managing Anchor book related activities and submission of letters to regulators post completion of anchor allocation, management of escrow accounts, finalisation of the basis of allotment based on technical rejections, post Offer stationery and preparation of CAN for Anchor Investors, essential follow-up steps including follow-up with bankers to the Offer and Self Certified Syndicate Banks and coordination with various agencies connected with the post-offer activity such as registrar to the offer, bankers to the offer, Self-Certified Syndicate Banks etc. listing of instruments, demat credit and refunds/ unblocking of funds, announcement of allocation and dispatch of refunds to Bidders, etc., payment of the applicable STT on behalf of Selling Shareholders, coordination for investor complaints related to the Offer, submission of final post issue report and coordination with SEBI and Stock Exchanges for refund of 1% security deposit.	Axis and ISEC	ISEC



## **Legal Counsel to the Company, Individual Selling Shareholder and Other Selling Shareholders as to Indian Law**

### **Khaitan & Co**

10<sup>th</sup> and 13<sup>th</sup> Floors, Tower 1C  
One World Centre  
841 Senapati Bapat Marg  
Mumbai 400 013, Maharashtra, India  
**Telephone:** +91 22 6636 5000

## **Legal Counsel to the BRLMs as to Indian Law**

### **Shardul Amarchand Mangaldas & Co**

24<sup>th</sup> Floor, Express Towers  
Nariman Point  
Mumbai 400 021, Maharashtra, India  
**Telephone:** +91 22 4933 5555

## **International Legal Counsel to the BRLMs**

### **Dentons US LLP**

2000, McKinney Avenue  
Suite 1900 Dallas,  
Texas 75201, United States of America  
**Telephone:** +1 214 259 0952

## **Legal Counsel to the Investor Selling Shareholder as to Indian Law**

### **Cyril Amarchand Mangaldas**

3<sup>rd</sup> Floor, Prestige Falcon Towers  
19, Brunton Road  
Bengaluru 560 025  
Karnataka, India  
**Telephone:** +91 80 6792 2000

## **Statutory Auditors**

### **Deloitte Haskins & Sells**

19<sup>th</sup> Floor, Shapath V  
S.G. Highway  
Ahmedabad 380 015, Gujarat  
**Telephone:** +91 79 6682 7320  
**E-mail:** kraval@deloitte.com  
**Peer review number:** 012965  
**Firm registration number:** 117365W

### **Advisor to the Company\***

#### **Metta Capital Advisors LLP**

803, Symphony  
Nehru Road, Vile Parle East  
Mumbai 400 057 Maharashtra  
**Telephone:** +91 (22) 2611 9900  
**Email:** dhiraj@mettacapital.in  
**Firm registration number:** AAH-7457

*\*for fund-raising including the Offer*

## **Changes in Auditors**

Except for the appointment of Deloitte Haskins & Sells with effect from April 1, 2019, there has been no change in the auditors of our Company during the three years preceding the date of this Draft Red Herring Prospectus.

## Bankers to our Company

### Axis Bank Ltd

G-02 Saaman II,  
Opp Shell Petrol Pump,  
100ft Road Ahmedabad 380 051  
Tel: +91 89 8080 0581/ +91 79 6190 4305

E-mail: [vejalpur.branchhead@axisbank.com](mailto:vejalpur.branchhead@axisbank.com)/  
[vejalpur.operationshead@axisbank.com](mailto:vejalpur.operationshead@axisbank.com)

Website: [www.axisbank.com](http://www.axisbank.com)

Contact Person: Shilpa Rathod

### HDFC Bank Ltd

A Wing, 3<sup>rd</sup> Floor, Trade Star Building,  
Opp. JB Nagar Fish Market, JB Nagar,  
Andheri East, Mumbai 400 059  
Tel: +91 9323109342

E-mail: [pankaj.chachra@hdfcbank.com](mailto:pankaj.chachra@hdfcbank.com)

Website: [www.hdfcbank.com](http://www.hdfcbank.com)

Contact Person: Pankaj Chachra

### Kotak Mahindra Bank Ltd

27, BKC, C27, G Block,  
Bandra Kurla Complex, Bandra E,  
Mumbai 400 051  
Tel: +91 22 66054144

E-mail: [neeraj.kulkarni@kotak.com](mailto:neeraj.kulkarni@kotak.com)

Website: [www.kotak.com](http://www.kotak.com)

Contact Person: Neeraj Kulkarni

## Banker(s) to the Offer

### *Escrow Collection Bank(s)*

[•]

### *Public Offer Account Bank(s)*

[•]

### *Refund Bank(s)*

[•]

### *Sponsor Bank*

[•]

## Designated Intermediaries

### SCSBs

The list of SCSBs notified by SEBI for the ASBA process is available at <http://www.sebi.gov.in/sebiweb/other/OtherAction.do?doRecognised=yes>, or at such other website as may be prescribed by SEBI from time to time.

A list of the Designated SCSB Branches with which an ASBA Bidder (other than RIIs using the UPI Mechanism), not bidding through Syndicate/Sub Syndicate or through a Registered Broker, RTA or CDP may submit the Bid cum Application Forms, is available at <https://www.sebi.gov.in/sebiweb/other/OtherAction.do?doRecognisedFpi=yes&intmId=34>, or at such other websites as may be prescribed by SEBI from time to time.

### SCSBs and mobile applications enabled for UPI Mechanism

In accordance with SEBI circular no. SEBI/HO/CFD/DIL2/CIR/P/2019/76 dated June 28, 2019 and SEBI circular no. SEBI/HO/CFD/DIL2/CIR/P/2019/85 dated July 26, 2019, Retail Individual Investors using the UPI Mechanism may apply through the SCSBs and mobile applications whose names appears on the website of the SEBI (<https://www.sebi.gov.in/sebiweb/other/OtherAction.do?doRecognisedFpi=yes&intmId=40>) and (<https://www.sebi.gov.in/sebiweb/other/OtherAction.do?doRecognisedFpi=yes&intmId=43>) respectively, as updated from time to time

### Syndicate SCSB Branches

In relation to Bids (other than Bids by Anchor Investors and RIIs) submitted under the ASBA process to a member of the Syndicate, the list of branches of the SCSBs at the Specified Locations named by the respective SCSBs to receive deposits of Bid cum Application Forms from the members of the Syndicate is available on the website of the SEBI (<http://www.sebi.gov.in/sebiweb/other/OtherAction.do?doRecognised=yes&intmId=35>) and updated from time to time. For more information on such branches collecting Bid cum Application Forms from the Syndicate at Specified Locations,

see the website of the SEBI <http://www.sebi.gov.in/sebiweb/other/OtherAction.do?doRecognised=yes&intmId=35> as updated from time to time.

### **Registered Brokers**

Bidders can submit ASBA Forms in the Offer using the stock-broker network of the stock exchange, i.e., through the Registered Brokers at the Broker Centres. The list of the Registered Brokers eligible to accept ASBA forms, including details such as postal address, telephone number and e-mail address, is provided on the websites of the Stock Exchanges at [www.bseindia.com](http://www.bseindia.com) and [www.nseindia.com](http://www.nseindia.com), as updated from time to time

### **Registrar and Share Transfer Agents**

The list of the CRTAs eligible to accept ASBA Forms at the Designated RTA Locations, including details such as address, telephone number and e-mail address, is provided on the websites of the Stock Exchanges at [www.bseindia.com/Static/Markets/PublicIssues/RtaDp.aspx?](http://www.bseindia.com/Static/Markets/PublicIssues/RtaDp.aspx?) and [www.nseindia.com/products/content/equities/ipos/asba\\_procedures.htm](http://www.nseindia.com/products/content/equities/ipos/asba_procedures.htm) respectively, as updated from time to time.

### **Collecting Depository Participants**

The list of the CDPs eligible to accept ASBA Forms at the Designated CDP Locations, including details such as their name and contact details, is provided on the websites of the Stock Exchanges at [www.bseindia.com/Static/Markets/PublicIssues/RtaDp.aspx?](http://www.bseindia.com/Static/Markets/PublicIssues/RtaDp.aspx?) and [www.nseindia.com/products/content/equities/ipos/asba\\_procedures.htm](http://www.nseindia.com/products/content/equities/ipos/asba_procedures.htm), respectively, as updated from time to time.

### **Credit Rating**

As this is an Offer consisting only of Equity Shares, there is no requirement to obtain credit rating for the Offer.

### **Debenture Trustee**

As this is an Offer consisting only of Equity Shares, the appointment of a debenture trustee is not required for the Offer.

### **Appraising Entity**

No appraising entity has been appointed in relation to the Offer.

### **Monitoring Agency**

Our Company shall in compliance with Regulation 41 of the SEBI ICDR Regulations, appoint a monitoring agency for monitoring the utilization of the Net Proceeds from the Fresh Issue prior to the filing of the Red Herring Prospectus. For details in relation to the proposed utilisation of the Net Proceeds, see the section titled “*Objects of the Offer*” on page 89.

### **Grading of the Offer**

No credit agency registered with SEBI has been appointed for obtaining grading for the Offer.

### **Green Shoe Option**

No green shoe option is contemplated under the Offer.

### **Expert**

Except as stated below, our Company has not obtained any expert opinions:

Our Company has received written consent dated January 18, 2022 from the Statutory Auditors namely, Deloitte Haskins & Sells, holding a valid peer review certificate from ICAI to include their name as required under Section 26(5) of the Companies Act, 2013 in this Draft Red Herring Prospectus and as an “expert” as defined under Section 2(38) of the Companies Act, 2013, in relation to the examination report dated January 17, 2022 on the Restated Consolidated Financial Information, and the statement of special tax benefits dated January 18, 2022 included in this Draft Red Herring Prospectus and such consent has not been withdrawn as on the date of this Draft Red Herring Prospectus. The term “experts” and consent thereof does not represent an expert or consent within the meaning under the U.S. Securities Act.

## Filing

A copy of this Draft Red Herring Prospectus has been filed electronically on the SEBI intermediary portal at <https://siportal.sebi.gov.in/intermediary/index.html>, in accordance with SEBI circular bearing reference SEBI/HO/CFD/DIL1/CIR/P/2018/011 dated January 19, 2018 and emailed at [cfddil@sebi.gov.in](mailto:cfddil@sebi.gov.in). in accordance with the instructions issued by the SEBI on March 27, 2020, in relation to “Easing of Operational Procedure – Division of Issues and Listing – CFD.” A copy of the Red Herring Prospectus, along with the material contracts and documents required to be filed under Section 32 of the Companies Act shall be filed with the RoC, and a copy of the Prospectus shall be filed with the RoC as required under Section 26 of the Companies Act and through the electronic portal at <http://www.mca.gov.in/mcafoportal/loginvalidateuser.do>.

## Book Building Process

Book Building Process, in the context of the Offer, refers to the process of collection of Bids from investors on the basis of the Red Herring Prospectus, the Bid cum Application Forms and the Revision Forms within the Price Band. The Price Band and minimum Bid Lot size, will be decided by our Company and the Selling Shareholders in consultation with the BRLMs and advertised in [●] editions of [●], an English national daily newspaper and [●] editions of [●], a Hindi national daily newspaper and [●] editions of [●], a Gujarati daily newspaper (Gujarati being the regional language of Gujarat, where our Registered Office is located), each with wide circulation, at least two Working Days prior to the Bid/ Offer Opening Date and shall be made available to the Stock Exchanges for the purpose of uploading on their respective websites. The Offer Price shall be determined by our Company and the Selling Shareholders in consultation with the BRLMs after the Bid/ Offer Closing Date.

**All Bidders, except Anchor Investors, are mandatorily required to use the ASBA process for participating in the Offer by providing details of their respective ASBA Account in which the corresponding Bid Amount will be blocked by SCSBs. In addition to this, the RIIs may participate through the ASBA process by either (a) providing the details of their respective ASBA Account in which the corresponding Bid Amount will be blocked by the SCSBs; or (b) through the UPI Mechanism. Anchor Investors are not permitted to participate in the Offer through the ASBA process.**

**In accordance with the SEBI ICDR Regulations, QIBs and Non-Institutional Investors bidding in the Non-Institutional Portion are not allowed to withdraw or lower the size of their Bids (in terms of the quantity of the Equity Shares or the Bid Amount) at any stage. Retail Individual Investors and Eligible Employees Bidding in the Employee Reservation Portion can revise their Bid(s) during the Bid/ Offer Period and withdraw their Bids on or before the Bid/ Offer Closing Date. Further, Anchor Investors cannot withdraw their Bids after the Anchor Investor Bid/ Offer Period. Allocation to the QIBs (other than Anchor Investors) and Non-Institutional Buyers will be on a proportionate basis while allocation to the Anchor Investors will be on a discretionary basis. For further details, see “Terms of the Offer” and “Offer Procedure” beginning on pages 341 and 351, respectively.**

**Each Bidder by submitting a Bid in the Offer, will be deemed to have acknowledged the above restrictions and the terms of the Offer.**

Our Company will comply with the SEBI ICDR Regulations and any other directions issued by SEBI in relation to this Offer. In this regard, our Company along with the Selling Shareholders have appointed the BRLMs to manage this Offer and procure Bids for this Offer.

**The Book Building Process is in accordance with guidelines, rules and regulations prescribed by SEBI and are subject to change from time to time. Bidders are advised to make their own judgment about an investment through this process prior to submitting a Bid in the Offer.**

For further details on the method and procedure for Bidding, see “Offer Procedure” on page 351, respectively.

Bidders should note that the Offer is also subject to obtaining (i) final listing and trading approvals of the Stock Exchanges, which our Company shall apply for after the Allotment; and (ii) final approval of the RoC after the Prospectus is filed with the RoC.

## Underwriting Agreement

After the determination of the Offer Price and allocation of Equity Shares, but prior to the filing of the Prospectus with the RoC, our Company and the Selling Shareholders intend to enter into an Underwriting Agreement with the

Underwriters for the Equity Shares proposed to be issued and offered in the Offer. The extent of underwriting obligations and the Bids to be underwritten by each BRLM shall be as per the Underwriting Agreement. The Underwriting Agreement is dated [●]. Pursuant to the terms of the Underwriting Agreement, the obligations of each of the Underwriters will be several and will be subject to certain conditions specified therein.

The Underwriters have indicated their intention to underwrite the following number of Equity Shares pursuant to the Underwriting Agreement:

*(This portion has been intentionally left blank and will be filled in before filing of the Prospectus with the RoC.)*

*(in ₹ million)*

Name, address, telephone number and email address of the Underwriters	Indicative number of Equity Shares to be underwritten	Amount underwritten
[●]	[●]	[●]

The abovementioned underwriting commitments are indicative and will be finalised after pricing of the Offer, the Basis of Allotment and actual allocation in accordance with provisions of the SEBI ICDR Regulations.

In the opinion of our Board, the resources of the abovementioned Underwriters are sufficient to enable them to discharge their respective underwriting obligations in full. The abovementioned Underwriters are registered with the SEBI under Section 12(1) of the SEBI Act or registered as merchant bankers with SEBI or registered as brokers with the Stock Exchanges. Our Board/ IPO Committee, at its meeting held on [●], has accepted and entered into the Underwriting Agreement mentioned above on behalf of our Company.

Allocation among the Underwriters may not necessarily be in proportion to their underwriting commitment set forth in the table above. Notwithstanding the above table, the Underwriters shall be severally responsible for ensuring payment with respect to the Equity Shares allocated to investors respectively procured by them.

The Underwriting Agreement has not been executed as on the date of this Draft Red Herring Prospectus and our Company and Selling Shareholder intend to enter into the Underwriting Agreement with the Underwriters after determination of the Offer Price and allocation of Equity Shares, but prior to filing the Prospectus with the RoC.

## CAPITAL STRUCTURE

The Equity Share capital of our Company as on the date of this Draft Red Herring Prospectus is as set forth below:

*(in ₹, except share data or indicated otherwise)*

		Aggregate value at face value	Aggregate value at Offer Price*
<b>A</b>	<b>AUTHORIZED SHARE CAPITAL</b>		
	53,700,000 Equity Shares of face value ₹ 5 each	268,500,000	-
	400,000 redeemable preference shares of face value of ₹ 5 each	2,000,000	-
	<b>Total</b>	<b>270,500,000</b>	<b>-</b>
<b>B</b>	<b>ISSUED, SUBSCRIBED AND PAID-UP CAPITAL BEFORE THE OFFER</b>		
	36,625,620 Equity Shares of face value ₹ 5 each	183,128,100	-
<b>C</b>	<b>PRESENT OFFER IN TERMS OF THIS DRAFT RED HERRING PROSPECTUS</b>		
	Offer of up to [●] Equity Shares	[●]	[●]
	<i>Of which</i>		
	Fresh Issue of up to [●] Equity Shares aggregating to ₹ 1,500.00 million <sup>(1)^</sup>	[●]	[●]
	Offer for Sale of up to [●] Equity Shares aggregating to ₹ 6,120.00 million <sup>(2)</sup>	[●]	[●]
	<i>Which includes:</i>		
	Employee Reservation portion of [●] Equity Shares aggregating to ₹ [●] million <sup>(3)</sup>	[●]	[●]
	Net Offer of [●] Equity Shares aggregating to ₹ [●] million	[●]	[●]
<b>D</b>	<b>ISSUED, SUBSCRIBED AND PAID-UP CAPITAL AFTER THE OFFER</b>		
	[●] Equity Shares	[●]	-
<b>E</b>	<b>SECURITIES PREMIUM ACCOUNT</b>		
	Before the Offer		425.27 million
	After the Offer		[●]

\* To be updated upon finalization of the Offer Price.

<sup>^</sup> Our Company and the Selling Shareholders, in consultation with the BRLMs, may consider the Pre-IPO Placement aggregating up to ₹ 300.00 million if undertaken, will be completed prior to filing of the Red Herring Prospectus with the RoC. If the Pre-IPO Placement is completed, the size of the Fresh Issue will be reduced to the extent of such Pre-IPO Placement, subject to the Offer constituting at least [●]% of the post-Offer paid up Equity Share capital of our Company.

<sup>(1)</sup> The Offer has been authorized by a resolution of our Board dated January 11, 2022 and the Fresh Issue has been authorized by our Shareholders pursuant to a special resolution passed on January 11, 2022.

<sup>(2)</sup> Each of the Selling Shareholders, severally and not jointly, confirms that their respective portion of the Offered Shares have been held by such Selling Shareholder for a period of at least one year prior to filing of this Draft Red Herring Prospectus and are eligible for the Offer for Sale in accordance with the provisions of the SEBI ICDR Regulations. Our IPO Committee has taken on record the approval for the Offer for Sale by the Selling Shareholders pursuant to a resolution dated January 11, 2022. For further details of authorizations received for the Offer for Sale, see "Other Regulatory and Statutory Disclosures" on page 331.

<sup>(3)</sup> Our Company and the Selling Shareholders, in consultation with the BRLMs, may offer an Employee Discount of up to [●]% to the Offer Price (equivalent to ₹ [●] per Equity Share), which shall be announced at least two Working Days prior to the Bid/Offer Opening Date.

### Changes in the authorised share capital of our Company

For details of the changes to the authorised share capital of our Company in the past 10 years, see "History and Certain Corporate Matters- Amendments to our Memorandum of Association" on page 167.

### Notes to the Capital Structure

#### 1. Equity share capital history of our Company

a) The following table sets forth the history of the equity share capital of our Company.

Date of allotment of equity shares	Reason/ Particulars of allotment of equity shares	No. of equity shares allotted	Cumulative No. of equity shares	Face value (₹)	Offer price per equity share (₹)	Form of consideration
February 23, 2006	Initial subscription to the MoA <sup>(1)</sup>	10,000	10,000	10	10	Cash
May 25, 2007	Preferential issue <sup>(2)</sup>	2,500	12,500	10	10	Cash

Date of allotment of equity shares	Reason/ Particulars of allotment of equity shares	No. of equity shares allotted	Cumulative No. of equity shares	Face value (₹)	Offer price per equity share (₹)	Form of consideration
May 16, 2009	Preferential issue <sup>(3)</sup>	487,500	500,000	10	10	Cash
June 1, 2010	Preferential issue <sup>(4)</sup>	400,000	900,000	10	10	Cash
January 25, 2016	Bonus issue of 10,000 equity shares of face value ₹10 each for every 70,488 equity shares of face value ₹ 10 each held <sup>(5)</sup>	127,682	1,027,682	10	NA	-
January 29, 2016	Conversion of CCPS <sup>(6)</sup>	291,083	1,318,765	10	NA	-
March 18, 2017	Bonus issue of five equity shares of face value ₹10 each for every equity share of face value ₹ 10 held <sup>(7)</sup>	6,593,825	7,912,590	10	NA	-
May 14, 2019	Allotment pursuant to the NCLT Order <sup>(8)</sup>	10,400,220	18,312,810	10	NA	Other than cash
November 10, 2021	Sub-division of the equity shares of our Company from face value of ₹ 10 each to ₹ 5 each. Pursuant to such sub-division, the issued and paid-up equity share capital of our Company was sub-divided from 18,312,810 equity shares of face value ₹ 10 each to 36,625,620 Equity Shares					

<sup>(1)</sup> Allotment of 5,000 equity shares of face value ₹ 10 each to Sanjay Karsandas Thakker and Ami Sanjay Thakker pursuant to initial subscription to the MoA.

<sup>(2)</sup> Allotment of 1,250 equity shares of face value ₹ 10 each to Amar Jatin Sheth and 1,250 equity shares of face value ₹ 10 each to Rishabh Jatin Sheth.

<sup>(3)</sup> Allotment of 442,500 equity shares of face value ₹ 10 each to Sanjay Karsandas Thakker and 45,000 equity shares of face value ₹ 10 each to Ami Sanjay Thakker

<sup>(4)</sup> Allotment of 400,000 equity shares of face value ₹ 10 each to Landmark Automobiles Private Limited.

<sup>(5)</sup> Allotment of 110,169 equity shares of face value ₹ 10 each to Sanjay Karsandas Thakker (jointly with Ami Sanjay Thakker), 5,009 equity shares of face value ₹ 10 each to Ami Sanjay Thakker (jointly with Sanjay Karsandas Thakker) and 12,504 equity shares of face value ₹ 10 each to TPG Growth.

<sup>(6)</sup> Allotment of 291,083 equity shares of face value ₹ 10 each to TPG Growth pursuant to conversion of 291,083 CCPS into 291,083 equity shares of face value ₹ 10 each, as per the conversion ratio of one equity share of face value ₹ 10 each for every CCPS held. The 291,083 CCPS had been allotted to TPG Growth on December 17, 2014 at the price of 1,701.92 per CCPS.

<sup>(7)</sup> Allotment of 4,433,630 equity shares of face value ₹ 10 each to Sanjay Karsandas Thakker (jointly with Ami Sanjay Thakker), 201,580 equity shares of face value ₹ 10 each to Ami Sanjay Thakker (jointly with Sanjay Karsandas Thakker) and 1,958,615 equity shares of face value ₹ 10 each to TPG Growth.

<sup>(8)</sup> Allotment of 2,257,028 equity shares of face value ₹ 10 each to Sanjay Karsandas Thakker (jointly with Ami Sanjay Thakker), 2,505,528 equity shares of face value ₹ 10 each to Ami Sanjay Thakker (jointly with Sanjay Karsandas Thakker), 3,089,259 equity shares of face value ₹ 10 each to TPG Growth, 876,224 equity shares of face value ₹ 10 each to Aastha Limited, 506,006 equity shares of face value ₹ 10 each to Garima Misra, 504,642 equity shares of face value ₹ 10 each to Hina Sachin Mehta, 378,861 equity shares of face value ₹ 10 each to Sanjay Karsandas Thakker HUF, 282,520 equity shares of face value ₹ 10 each to Aryaman Sanjay Thakker (jointly with Sanjay Karsandas Thakker) and 152 equity shares of face value ₹ 10 each to Promila Mittal pursuant to the Schemes of Arrangement.

b) Our Company does not have any outstanding preference shares as on the date of the filing of this Draft Red Herring Prospectus.

## 2. Equity shares issued for consideration other than cash or by way of bonus issue

Except as detailed below, our Company has not issued any equity shares for consideration other than cash or by way of bonus issue since incorporation:

Date of allotment of equity shares	Reason/ Particulars of allotment of equity shares	No. of equity shares allotted	Face value (₹)	Offer price per equity share (₹)	Form of consideration	Benefits accrued to our Company
January 25, 2016	Bonus issue of 10,000 equity shares of face value ₹ 10 for every 70,488 equity shares of face value ₹ 10 each held <sup>(1)</sup>	127,682	10	NA	-	-
March 18, 2017	Bonus issue of five equity shares of face value ₹10 each	6,593,825	10	NA	-	-

Date of allotment of equity shares	Reason/ Particulars of allotment of equity shares	No. of equity shares allotted	Face value (₹)	Offer price per equity share (₹)	Form of consideration	Benefits accrued to our Company
	for every equity share of face value ₹ 10 held <sup>(2)</sup>					
May 14, 2019	Allotment pursuant to NCLT Order <sup>(3)</sup>	10,400,220	10	NA	Other than Cash	Completion of the activities contemplated under the Schemes of Arrangement

<sup>(1)</sup> Allotment of 110,169 equity shares of face value ₹ 10 each to Sanjay Karsandas Thakker (jointly with Ami Sanjay Thakker), 5,009 equity shares of face value ₹ 10 each to Ami Sanjay Thakker (jointly with Sanjay Karsandas Thakker) and 12,504 to TPG Growth.

<sup>(2)</sup> Allotment of 4,433,630 equity shares of face value ₹ 10 each to Sanjay Karsandas Thakker (jointly with Ami Sanjay Thakker), 201,580 equity shares of face value ₹ 10 each to Ami Sanjay Thakker (jointly with Sanjay Karsandas Thakker) and 1,958,615 to TPG Growth.

<sup>(3)</sup> Allotment of 2,257,028 equity shares of face value ₹ 10 each to Sanjay Karsandas Thakker (jointly with Ami Sanjay Thakker), 2,505,528 equity shares of face value ₹ 10 each to Ami Sanjay Thakker (jointly with Sanjay Karsandas Thakker), 3,089,259 equity shares of face value ₹ 10 each to TPG Growth, 876,224 equity shares of face value ₹ 10 each to Aastha Limited, 506,006 equity shares of face value ₹ 10 each to Garima Misra, 504,642 equity shares of face value ₹ 10 each to Hina Sachin Mehta, 378,861 equity shares of face value ₹ 10 each to Sanjay Karsandas Thakker HUF, 282,520 equity shares of face value ₹ 10 each to Aryaman Sanjay Thakker (jointly with Sanjay Karsandas Thakker) and 152 equity shares of face value ₹ 10 each to Promila Mittal pursuant to the Schemes of Arrangement.

### 3. Issue of shares at a price lower than the Offer Price in the last year

Our Company has not issued any Equity Shares during a period of one year preceding the date of this Draft Red Herring Prospectus.

### 4. Details of equity shares issued under employee stock option schemes

As on the date of this Draft Red Herring Prospectus, our Company has not issued any equity shares pursuant to the ESOP Scheme.

### 5. Issue of Equity Shares out of revaluation reserves

Our Company has not issued any Equity Shares or preference shares out of its revaluation reserves at any time since incorporation.

### 6. Issue of Equity Shares pursuant to scheme of arrangement

Except for the allotment of 10,400,220 equity shares of face value ₹ 10 each on May 14, 2019 pursuant to the Schemes of Arrangement, details of which are set forth above in “Notes to the Capital Structure-Equity Share capital history of our Company” on page 76, our Company has not issued or allotted any equity shares pursuant to schemes of arrangement approved under Sections 391-394 of the Companies Act, 1956 or Sections 230-234 of the Companies Act, 2013.

### 7. All transactions in Equity Shares by our Promoter and members of our Promoter group between the date of filing of this Draft Red Herring Prospectus and the date of closing of the Offer shall be reported to the Stock Exchanges within 24 hours of such transactions.



## 8. Shareholding Pattern of our Company

The table below presents the shareholding pattern of our Company as on the date of this Draft Red Herring Prospectus.

Category (I)	Category of shareholder (II)	Number of shareholders (III)	Number of fully paid-up Equity Shares held (IV)	Number of partly paid-up Equity Shares held (V)	Number of shares underlying depository receipts (VI)	Total number of shares held (VII) = (IV)+(V)+(VI)	Shareholding as a % of total number of shares (calculated as per SCRR, 1957) (VIII) As a % of (A+B+C2)	Number of voting rights held in each class of securities (IX)			Number of shares underlying outstanding convertible securities (including warrants) (X)	Shareholding, as a % assuming full conversion of convertible securities (as a percentage of diluted share capital) (XI) = (VII) + (X) As a % of (A+B+C2)	Number of locked in shares (XII)		Number of shares pledged or otherwise encumbered (XIII)		Number of Equity Shares held in dematerialized form (XIV)	
								Number of Voting Rights					Total as a % of (A+B+C)	Number (a)	As a % of total Shares held (b)	Number (a)		As a % of total shares held (b)
								Class e.g.: Equity Shares	Class e.g.: Others	Total								
(A)	Promoter and Promoter Group	4	22,062,378	NA	NA	22,062,378	60.24%	22,062,378	NA	22,062,378	60.24%	NA	60.24%	NA	NA	NA	NA	22,062,378
(B)	Public	7	14,563,242	NA	NA	14,563,242	39.76%	14,563,242	NA	14,563,242	39.76%	NA	39.76%	NA	NA	NA	NA	14,563,242
(C)	Non-Promoter-Non Public	NA	NA	NA	NA	NA	NA	NA	NA	NA	NA	NA	NA	NA	NA	NA	NA	NA
(C1)	Shares underlying depository receipts	NA	NA	NA	NA	NA	NA	NA	NA	NA	NA	NA	NA	NA	NA	NA	NA	NA
(C2)	Shares held by Employee Trusts	NA	NA	NA	NA	NA	NA	NA	NA	NA	NA	NA	NA	NA	NA	NA	NA	NA
	<b>Total</b>	<b>11</b>	<b>36,625,620</b>	<b>NA</b>	<b>NA</b>	<b>36,625,620</b>	<b>100.00%</b>	<b>36,625,620</b>	<b>NA</b>	<b>36,625,620</b>	<b>100.00%</b>	<b>NA</b>	<b>100.00%</b>	<b>NA</b>	<b>NA</b>	<b>NA</b>	<b>NA</b>	<b>36,625,620</b>

## 9. Other details of shareholding of our Company

- (a) As on the date of the filing of this Draft Red Herring Prospectus, our Company has 11 Shareholders.
- (b) Set forth below is a list of Shareholders holding 1% or more of the paid-up Equity Share capital of our Company, as on the date of filing of this Draft Red Herring Prospectus:

Sr. No.	Name of the Shareholder	Number of Equity Shares held	Percentage of the pre-Offer Equity Share Capital (%)	Number of Equity Shares on a fully diluted basis	Percentage of the pre-Offer Equity Share Capital on a fully diluted basis (%)
1.	Sanjay Karsandas Thakker*	15,154,768	41.38	15,154,768	39.45
2.	TPG Growth	10,879,194	29.70	10,879,194	28.32
3.	Ami Sanjay Thakker#	5,584,848	15.25	5,584,848	14.54
4.	Aastha Limited	1,462,448	3.99	1,462,448	3.81
5.	Garima Misra	1,012,012	2.76	1,012,012	2.63
6.	Hina Mehta	1,009,284	2.76	1,009,284	2.63
7.	Sanjay Karsandas Thakker HUF	757,722	2.07	757,722	1.97
8.	Aryaman Sanjay Thakker#	565,040	1.54	565,040	1.47
	<b>Total</b>	<b>36,425,316</b>	<b>99.45</b>	<b>36,425,316</b>	<b>94.82</b>

\*Shares jointly held with Ami Sanjay Thakker

# Shares jointly held with Sanjay Karsandas Thakker

- (c) Set forth below is a list of Shareholders holding 1% or more of the paid-up Equity Share capital of our Company, as of 10 days prior to the date of filing of this Draft Red Herring Prospectus.

Sr. No.	Name of the Shareholder	Number of Equity Shares held	Percentage of the pre-Offer Equity Share capital (%)	Number of Equity Shares on a fully diluted basis	Percentage of the pre-Offer Equity Share capital on a fully diluted basis (%)
1.	Sanjay Karsandas Thakker*	15,154,768	41.38	15,154,768	39.46
2.	TPG Growth	10,879,194	29.70	10,879,194	28.33
3.	Ami Sanjay Thakker#	5,584,848	15.25	5,584,848	14.54
4.	Aastha Limited	1,462,448	3.99	1,462,448	3.81
5.	Garima Misra	1,012,012	2.76	1,012,012	2.64
6.	Hina Mehta	1,009,284	2.76	1,009,284	2.63
7.	Sanjay Karsandas Thakker HUF	757,722	2.07	757,722	1.97
8.	Aryaman Sanjay Thakker#	565,040	1.54	565,040	1.47
	<b>Total</b>	<b>36,425,316</b>	<b>99.45</b>	<b>36,425,316</b>	<b>94.85</b>

\* Shares jointly held with Ami Sanjay Thakker

# Shares jointly held with Sanjay Karsandas Thakker

- (d) Set forth below is a list of Shareholders holding 1% or more of the paid-up equity share capital of our Company, as of one year prior to the date of filing of this Draft Red Herring Prospectus.

Sr. No.	Name of the Shareholder	Number of equity shares held (face value of ₹ 10 each)	Percentage of the pre-Offer equity share capital (%)	Number of equity shares on a fully diluted basis	Percentage of the pre-Offer equity share capital on a fully diluted basis (%)
1.	Sanjay Karsandas Thakker*	7,577,384	41.38	7,577,384	39.48
2.	TPG Growth	5,439,597	29.70	5,439,597	28.34
3.	Ami Sanjay Thakker#	2,792,424	15.25	2,792,424	14.55
4.	Aastha Limited	731,224	3.99	731,224	3.81
5.	Garima Misra	506,006	2.76	506,006	2.64
6.	Hina Mehta	504,642	2.76	504,642	2.63
7.	Sanjay Karsandas Thakker HUF	378,861	2.07	378,861	1.97
8.	Aryaman Sanjay Thakker#	282,520	1.54	282,520	1.47
	<b>Total</b>	<b>18,212,658</b>	<b>99.45</b>	<b>18,212,658</b>	<b>94.89</b>

\* Shares jointly held with Ami Sanjay Thakker  
# Shares jointly held with Sanjay Karsandas Thakker

(e) Set forth below is a list of Shareholders holding 1% or more of the paid-up Equity Share Capital of our Company, as of two years prior to the date of filing of this Draft Red Herring Prospectus.

Sr. No.	Name of the Shareholder	Number of equity shares held (Face value of ₹ 10 each)	Percentage of the pre-Offer equity share capital (%)	Number of equity shares on a fully diluted basis	Percentage of the pre-Offer equity share capital on a fully diluted basis (%)
1.	Sanjay Karsandas Thakker*	7,577,384	41.38	7,577,384	39.48
2.	TPG Growth	5,439,597	29.70	5,439,597	28.34
3.	Ami Sanjay Thakker#	2,792,424	15.25	2,792,424	14.55
4.	Aastha Limited	731,224	3.99	731,224	3.81
5.	Garima Misra	506,006	2.76	506,006	2.64
6.	Hina Mehta	504,642	2.76	504,642	2.63
7.	Sanjay Karsandas Thakker HUF	378,861	2.07	378,861	1.97
8.	Aryaman Sanjay Thakker#	282,520	1.54	282,520	1.47
	<b>Total</b>	<b>18,212,658</b>	<b>99.45</b>	<b>18,212,658</b>	<b>94.89</b>

\* Shares jointly held with Ami Sanjay Thakker  
# Shares jointly held with Sanjay Karsandas Thakker

- (f) Except for Equity Shares or employee stock options that may be allotted pursuant to the ESOP Scheme, our Company presently does not intend or propose and is not under negotiations or considerations to alter its capital structure for a period of six months from the Bid/Offer Opening Date, by way of split or consolidation of the denomination of Equity Shares, or by way of further issue of Equity Shares (including issue of securities convertible into or exchangeable, directly or indirectly for Equity Shares), whether on a preferential basis, or by way of issue of bonus Equity Shares, or on a rights basis, or by way of further public issue of Equity Shares, or otherwise.
- (g) Except for options granted pursuant to the ESOP Scheme, there are no outstanding options or convertible securities, including any outstanding warrants or rights to convert debentures, loans or other instruments convertible into our Equity Shares as on the date of this Draft Red Herring Prospectus.

#### 10. Employee Stock Option Scheme

Pursuant to a resolution of our Board of Directors dated March 31, 2018, and Shareholders resolution dated April 6, 2018, our Company had instituted an employee stock option scheme, the LCPL Employee Stock Option Scheme, 2018 (“Scheme”). Upon sanction of the Schemes of Arrangement, the existing stock option schemes of AMPL and LAPL were adopted by the Board on September 11, 2019.

The ESOP Scheme was amended pursuant to the resolutions of our Board on October 28, 2021, and Shareholders on November 10, 2021 and January 11, 2022 and the name of the ESOP Scheme was changed to ‘Landmark Cars Limited Employee Stock Option Scheme’. The ESOP Scheme is in compliance with the SEBI SBEB Regulations.

Further, in terms of ESOP Scheme, a fair and reasonable adjustment may be made to the number of stock options or their exercise price by our Board, in the event of corporate actions like, *inter alia*, rights issues, bonus issues, mergers or the sale of a division.

As on the date of this Draft Red Herring Prospectus, 1,790,792 options have been granted by our Company under ESOP Scheme. The details of the ESOP Scheme are as follows:

Particulars	Fiscal 2019	Fiscal 2020	Fiscal 2021	For the half year ended September 30, 2021	From October 1, 2021 to November 9, 2021	From November 10, 2021 to the date of this DRHP
Total options outstanding as at the beginning of the period	-	8,79,023	8,79,023	8,95,023	8,95,023	1,778,792##

Particulars	Fiscal 2019	Fiscal 2020	Fiscal 2021	For the half year ended September 30, 2021	From October 1, 2021 to November 9, 2021	From November 10, 2021 to the date of this DRHP
<b>Total options granted during the year/ period</b>	<b>879,023</b>	-	<b>16,000</b>	-	<b>31,000</b>	<b>12,000</b>
No of employees to whom options are granted	15	-	3	-	4	3
Vesting period	One year from the date of the grant					
Exercise price of options in ₹ (as on the date of grant of options)	233.50	-	333.00	-	489.00	244.50**
Options forfeited/ lapsed/ cancelled	-	-	-	-	(36,627)	-
Variation of terms of options	No <sup>#</sup>	No	No	No	No	No
Money realized by exercise of options (in ₹)	-	-	-	-	-	-
Total number of options outstanding in force of face value ₹ 10	879,023	879,023	895,023	895,023	889,396	-
Total number of options outstanding in force of face value ₹ 5	-	-	-	-	-	1,790,792
<b>Total options vested (excluding the options that have been exercised) of face value ₹ 10</b>	<b>879,023</b>	-	-	-	-	-
Options exercised (since implementation of the ESOP Scheme)	-	-	-	-	-	-
The total number of Equity Shares of face value ₹ 5 each that would arise as a result of full exercise of options granted (net of forfeited/ lapsed/ cancelled options) <sup>##</sup>	1,758,046	1,758,046	1,790,046	1,790,046	1,778,792	1,790,792
<b>Employee wise details of options granted to:</b>	Options of face value ₹ 10					Options of face value ₹ 5
<b>(i) Key managerial personnel</b>						
a) Paras Somani	274,692	-	-	-	-	-
b) Rajiv Bal Vohra	91,564	-	-	-	-	-
c) Harshal Manojkumar Desai	36,627	-	-	-	25,000	-
d) Devang Satyadev Dave	274,692	-	-	-	-	-
e) Urvi Ashwin Mody	36,627	-	-	-	-	-
f) Surendra Kumar Agarwal	-	-	7,000	-	-	-
<b>(ii) Any other employee who received a grant in any one year of options amounting to 5% or more of the options granted during the year/ period</b>						
a) Neerav Shah	-	-	7,000	-	-	-
b) Bal Krishna Arora	-	-	2,000	-	-	-
c) Kapil Asnani	-	-	-	-	2,000	-
d) Kuntal Merchant	-	-	-	-	2,000	-
e) Ketan Shah	-	-	-	-	2,000	-
f) K. Ravi Shankar	-	-	-	-	-	4,000
g) Sridhar R	-	-	-	-	-	4,000
h) Neelmani Sharma	-	-	-	-	-	4,000
<b>(iii) Identified employees who were granted options during any one year equal to or exceeding 1% of the</b>						

Particulars	Fiscal 2019	Fiscal 2020	Fiscal 2021	For the half year ended September 30, 2021	From October 1, 2021 to November 9, 2021	From November 10, 2021 to the date of this DRHP
<b>issued capital (excluding outstanding warrants and conversions) of the Company at the time of grant</b>						
a) Paras Somani	274,692	-	-	-	-	-
b) Devang Satyadev Dave	274,692	-	-	-	-	-
Diluted earnings per share pursuant to the issue of Equity Shares on exercise of options in accordance with IND AS 33 'Earnings Per Share' (in ₹)	(7.00)	(7.84)	3.05	7.40	NA	NA
Where the Company has calculated the employee compensation cost using the intrinsic value of the stock options, the difference, if any, between employee compensation cost so computed and the employee compensation calculated on the basis of fair value of the stock options and the impact of this difference, on the profits of the Company and on the earnings per share of the Company	Not Applicable, as the company is calculating employee compensation cost using fair value at grant date					
Method and significant assumptions used to estimate the fair value of options granted during the year including, weighted average information, namely, risk-free interest rate, expected life, expected volatility, expected dividends, and the price of the underlying share in the market at the time of grant of option	The fair valuation of options was carried out by using the Black Scholes Model. The various inputs and assumptions considered in the pricing model at grant date for the stock options granted under Scheme are mentioned in the below table. Accordingly, share based payment expense recognised in the Restated Consolidated Statement of Profit and Loss for the six months ended September 30, 2021 is ₹ 0.51 million (March 31, 2021: ₹ 0.01 million, March 31, 2020: ₹ 1.22 million and March 31, 2019: ₹ 54.29 million)					
<i>Method of Valuation</i>	Black Scholes Model					
<i>Weighted Average Exercise Price</i>	233.50	-	235.28	-	243.77*	122.92^
<i>Expected Volatility (%)</i>	13.62%	-	13.62%	-	21.36%	21.36%
<i>Dividend Yield (%)</i>	-	-	-	-	-	-
<i>Expected Life (Years)</i>	4	-	4	-	4	4
<i>Risk Free Interest Rate (%)</i>	7.12%	-	7.12%	-	6.22%	6.22%
Impact on the profits and on the Earnings Per Share of the last three years if the accounting policies specified in the (Share Based Employee Benefits and Sweat Equity) Regulations, 2021 had been followed, in respect of options granted in the last three years	Not applicable, as the company is calculating employee compensation cost using fair value at grant date.					
Intention of key managerial personnel and whole-time directors who are holders of Equity Shares allotted on exercise of options to sell their shares within three months after the listing of Equity Shares pursuant to the Offer	Not applicable, as none of the options outstanding as on date are exercised.					
Intention to sell Equity Shares arising out of ESOP Scheme within three	Nil					

Particulars	Fiscal 2019	Fiscal 2020	Fiscal 2021	For the half year ended September 30, 2021	From October 1, 2021 to November 9, 2021	From November 10, 2021 to the date of this DRHP
months after the listing of Equity Shares by directors, senior managerial personnel and employees having Equity Shares arising out of the Scheme, amounting to more than 1% of the issued capital (excluding outstanding warrants and conversions)						

# Pursuant to a resolution in the board meeting dated October 28, 2021, Board of directors have approved extension of the exercise period by additional one year.

## Pursuant to a resolution in the board meeting dated January 11, 2022, Board of directors have resolved that (1) pursuant to reduction of the face value of the Equity Shares from ₹ 10 to ₹ 5 the Options of face value ₹ 10 originally granted to the employees will be doubled to Options of face value ₹ 5, (2) the name of the scheme shall be changed to "Landmark Cars Limited Employee Stock Option Scheme" and (3) the exercise price shall also be adjusted appropriately to reflect the reduced face value of The Equity Shares.

\* 31,000 options (original grant i.e., before split) were granted on October 28, 2021 and 36,627 options (original grant i.e., before split) were cancelled on November 1, 2021. In view of this, weighted average exercise price, at the time of granting of 31,000 options, has been calculated without giving effect of subsequent cancellation of 36,627 options.

\*\* The Company granted 12,000 options (post share split) in the Board meeting dated January 11, 2022. For such options, the Company has considered exercise price ₹ 244.50.

^ Post share split.

#### 11. Details of shareholding of our Promoter and members of the Promoter Group in our Company

- i. As on the date of this Draft Red Herring Prospectus, our Promoter, along with our Promoter Group hold 22,062,378 Equity Shares, equivalent to 60.24% of the issued, subscribed and paid-up Equity Share capital of our Company, as set forth in the table below along with details of the Equity Shares held by members of the Promoter Group.

Sr. No.	Name of the Shareholder	Pre-Offer Equity Share capital		Post-Offer Equity Share capital*	
		No. of Equity Shares	% of total shareholding	No. of Equity Shares	% of total shareholding
<b>Promoter</b>					
1.	Sanjay Karsandas Thakker (jointly with Ami Sanjay Thakker)	15,154,768	41.38	[●]	[●]
<b>Promoter Group</b>					
2.	Ami Sanjay Thakker (jointly with Sanjay Karsandas Thakker)	5,584,848	15.25	[●]	[●]
3.	Aryaman Sanjay Thakker (jointly with Sanjay Karsandas Thakker)	565,040	1.54	[●]	[●]
4.	Sanjay Karsandas Thakker HUF	757,722	2.07	[●]	[●]
	<b>Total</b>	<b>22,062,378</b>	<b>60.24</b>	<b>[●]</b>	<b>[●]</b>

\* Subject to finalisation of Basis of Allotment

- ii. All Equity Shares held by our Promoter are in dematerialized form as on the date of this Draft Red Herring Prospectus.
- iii. Build-up of the Promoter's shareholding in our Company

The build-up of the Equity Shareholding of our Promoter since incorporation of our Company is set forth in the table below.

Date of allotment/ transfer	Nature of transaction	No. of equity shares	Face value per equity share (₹)	Offer price/ Transfer price per equity share (₹)	Percentage of the pre-Offer Equity Share capital (%)*	Percentage of the post-Offer Equity Share capital (%)**
February 23, 2006	Initial subscription to the MoA	5,000	10	10	0.03	[•]
May 5, 2009	Transfer from Amar Jatin Sheth and Rishab Jatin Sheth	2,500	10	10	0.01	[•]
May 16, 2009	Preferential issue	442,500	10	10	2.42	[•]
March 29, 2014	Transfer from Landmark Automobiles Private Limited	400,000	10	60.75	2.18	[•]
December 17, 2014	Transfer to TPG Growth	(73,443)	10	1,701.92	(0.40)	[•]
January 25, 2016	Bonus issue	110,169	10	NA	0.60	[•]
March 18, 2017	Bonus issue	4,433,630	10	NA	24.21	[•]
May 14, 2019	Allotment pursuant to NCLT Order	2,257,028	10	NA	12.32	[•]
November 10, 2021	Sub-division of equity shares from face value of ₹10 each to ₹5 each, pursuant to which 7,577,384 equity shares of ₹10 held by Sanjay Karsandas Thakker (jointly with Ami Sanjay Thakker) have been sub-divided into 15,154,768 Equity Shares.					
<b>TOTAL</b>		<b>15,154,768</b>			<b>41.38</b>	

\*As adjusted for the sub-division of face value of equity shares of our Company from ₹10 each to ₹5 each.

\*\* Subject to finalisation of Basis of Allotment.

- iv. All the Equity Shares held by our Promoter were fully paid-up on the respective dates of allotment of such Equity Shares. Further, none of the Equity Shares held by our Promoter are pledged.
  - v. None of the members of the Promoter Group, the Promoter, or the Directors and their relatives have purchased or sold any securities of our Company during the period of six months immediately preceding the date of this Draft Red Herring Prospectus.
  - vi. There have been no financing arrangements whereby our Promoter, members of the Promoter Group, our Directors and their relatives have financed the purchase by any other person of securities of our Company (other than in the normal course of the business of the relevant financing entity) during a period of six months immediately preceding the date of this Draft Red Herring Prospectus.
12. Except as disclosed below, there have been no Equity Shares acquired by our Promoter Group, Selling Shareholders, shareholders entitled to the right to nominate directors or any other rights in the three years preceding the date of this Draft Red Herring Prospectus:

Name of acquirer	Date of acquisition	Number of Equity Shares acquired*	Acquisition price per Equity Share (including securities premium)** (₹)
Sanjay Karsandas Thakker (jointly with Ami Sanjay Thakker)	May 14, 2019	4,514,055	-
Ami Sanjay Thakker (jointly with Sanjay Karsandas Thakker)	May 14, 2019	5,011,055	-
Aryaman Sanjay Thakker (jointly with Sanjay Karsandas Thakker)	May 14, 2019	565,040	-
Sanjay Karsandas Thakker HUF	May 14, 2019	757,722	-
TPG Growth	May 14, 2019	6,178,518	-
Aastha Limited	May 14, 2019	1,752,448	-

Name of acquirer	Date of acquisition	Number of Equity Shares acquired*	Acquisition price per Equity Share (including securities premium)** (₹)
Garima Misra	May 14, 2019	1,012,012	-
Ami Sanjay Thakker (jointly with Sanjay Karsandas Thakker)	January 6, 2020	90,000	149.85

\*The number of equity shares acquired have been adjusted for the sub-division of each equity share of ₹10 each to two Equity Shares of ₹5 each pursuant to the meeting of the Shareholders on November 10, 2021.

\*\*Acquisitions were pursuant to the NCLT Order.

### 13. Details of Promoter's contribution and lock-in for 18 months

- Pursuant to Regulations 14 and 16(1)(a) of the SEBI ICDR Regulations, an aggregate of 20% of the fully diluted post-Offer Equity Share capital of our Company held by the Promoter shall be locked in for a period of 18 months as minimum promoter's contribution from the date of Allotment ("Promoter's Contribution"), and the Promoter's shareholding in excess of 20% of the fully diluted post-Offer Equity Share capital shall be locked-in for a period of six months from the date of Allotment.
- Details of the Equity Shares to be locked-in for 18 months from the date of Allotment as Promoter's Contribution are set forth in the table below.

Name of the Promoter	Date of allotment of the Equity Shares	Nature of transaction	No. of Equity Shares**	Face value (₹)	Offer/ acquisition price per Equity Share (₹)	No. of Equity Shares locked-in*	Percentage of the post-Offer paid-up capital (%)	Date up to which the Equity Shares are subject to lock-in
Sanjay Karsandas Thakker	[•]	[•]	[•]	[•]	[•]	[•]	[•]	[•]
<b>Total</b>						[•]	[•]	

\* Subject to finalisation of Basis of Allotment.

\*\* All the Equity Shares were fully paid-up on the respective dates of allotment or acquisition, as the case may be, of such Equity Shares.

- Our Promoter has given consent to include such number of Equity Shares held by him as may constitute 20% of the fully diluted post-Offer Equity Share capital of our Company as Promoter's Contribution. Our Promoter has agreed not to sell, transfer, charge, pledge or otherwise encumber in any manner, the Promoter's Contribution from the date of filing this Draft Red Herring Prospectus, until the expiry of the lock-in period specified above, or for such other time as required under SEBI ICDR Regulations, except as may be permitted, in accordance with the SEBI ICDR Regulations.
- Our Company undertakes that the Equity Shares that are being locked-in are not and will not be ineligible for computation of Promoter's Contribution in terms of Regulation 15 of the SEBI ICDR Regulations. In this connection, we confirm the following:
  - The Equity Shares offered for Promoter's Contribution do not include equity shares acquired in the three immediately preceding years (a) for consideration other than cash involving revaluation of assets or capitalisation of intangible assets; or (b) resulting from a bonus issue of Equity Shares out of revaluation reserves or unrealised profits of our Company or from a bonus issuance of equity shares against Equity Shares, which are otherwise ineligible for computation of Promoter's Contribution;
  - The Promoter's Contribution does not include any Equity Shares acquired during the immediately preceding one year at a price lower than the price at which the Equity Shares are being offered to the public in the Offer;
  - Our Company has not been formed by the conversion of a partnership firm or a limited liability partnership firm into a company and hence, no Equity Shares have been issued in the one year immediately preceding the date of this Draft Red Herring Prospectus pursuant to conversion from a partnership firm; and
  - The Equity Shares forming part of the Promoter's Contribution are not subject to any pledge.



**14. *Details of other Equity Shares locked-in for six months***

In terms of Regulation 16(1)(b) and Regulation 17 of the SEBI ICDR Regulations, the entire pre-Offer Equity Share capital of our Company (other than the Promoter's Contribution) will be locked-in for a period of six months from the date of Allotment in the Offer, except (a) the Equity Shares allotted to the employees under ESOP Schemes pursuant to exercise of options held by such employees (whether currently employees or not); (b) Equity Shares held by a venture capital fund ("VCF") or alternative investment fund of category I or category II ("AIF") or a foreign venture capital investor ("FVCI"), provided that such Equity Shares were locked-in for a period of at least six months from the date of purchase by the VCF or AIF or FVCI, and (c) Offered Shares, which are successfully transferred as part of the Offer for Sale.

Any unsubscribed portion of the Offered Shares would also be locked-in as required under the SEBI ICDR Regulations.

**15. *Lock-in of Equity Shares Allotted to Anchor Investors***

Any Equity Shares Allotted to Anchor Investors in the Anchor Investor Portion shall be locked in for a period of 30 days from the date of Allotment or any other period as per applicable law.

**16. *Recording on non-transferability of Equity Shares locked-in***

As required under Regulation 20 of the SEBI ICDR Regulations, our Company shall ensure that the details of the Equity Shares locked-in are recorded by the relevant Depository.

**17. *Other requirements in respect of lock-in***

Pursuant to Regulation 21 of the SEBI ICDR Regulations, Equity Shares held by our Promoter and locked-in, as mentioned above, may be pledged as collateral security for a loan with a scheduled commercial bank, a public financial institution, Systemically Important Non-Banking Financial Company or a deposit accepting housing finance company, subject to the following:

- (a) With respect to the Equity Shares locked-in for six months from the date of Allotment, such pledge of the Equity Shares must be one of the terms of the sanction of the loan.
- (b) With respect to the Equity Shares locked-in as Promoter's Contribution for 18 months from the date of Allotment, the loan must have been granted to our Company for the purpose of financing one or more of the objects of the Offer, which is not applicable in the context of this Offer.

However, the relevant lock-in period shall continue post the invocation of the pledge referenced above, and the relevant transferee shall not be eligible to transfer to the Equity Shares till the relevant lock-in period has expired in terms of the SEBI ICDR Regulations.

In terms of Regulation 22 of the SEBI ICDR Regulations, Equity Shares held by our Promoter and locked-in, may be transferred to any member of our Promoter Group or a new promoter, subject to continuation of lock-in applicable with the transferee for the remaining period and compliance with provisions of the Takeover Regulations.

Further, in terms of Regulation 22 of the SEBI ICDR Regulations, Equity Shares held by persons other than our Promoter prior to the Offer and locked-in for a period of six months, may be transferred to any other person holding Equity Shares which are locked in along with the Equity Shares proposed to be transferred, subject to the continuation of the lock in with the transferee and compliance with the provisions of the Takeover Regulations.

18. Our Company, the Promoter, the Directors and the BRLMs have no existing buyback arrangements and or any other similar arrangements for the purchase of Equity Shares being offered through the Offer.
19. None of the Directors or Key Managerial Personnel of our Company, except Sanjay Karsandas Thakker and Aryaman Sanjay Thakker (Directors) and Garima Misra (Key Managerial Personnel) hold any Equity Shares in our Company. For further details, see "*Our Management - Shareholding of Directors in our Company*" and "*Our Management - Shareholding of the Key Managerial Personnel*" on pages 184 and 195, respectively.

20. All Equity Shares issued pursuant to the Offer shall be fully paid-up at the time of Allotment and there are no partly paid-up Equity Shares as on the date of this Draft Red Herring Prospectus.
21. As on the date of this Draft Red Herring Prospectus, the BRLMs and their respective associates (as defined in the Securities and Exchange Board of India (Merchant Bankers) Regulations, 1992 do not hold any Equity Shares of our Company. The BRLMs and their affiliates may engage in the transactions with and perform services for our Company in the ordinary course of business or may in the future engage in commercial banking and investment banking transactions with our Company for which they may in the future receive customary compensation.
22. None of the Promoter or other members of our Promoter Group will participate in the Offer except to the extent of participation by Sanjay Karsandas Thakker HUF as a Selling Shareholder in the Offer for Sale.
23. Except for (i) the Pre-IPO Placement; and/or (ii) allotment of Equity Shares upon any exercise of options vested pursuant to the ESOP Scheme, there will be no further issue of Equity Shares whether by way of issue of bonus shares, preferential allotment, rights issue or in any other manner during the period commencing from filing of the Draft Red Herring Prospectus with SEBI until the Equity Shares are listed on the Stock Exchanges or all application monies have been refunded, as the case may be. Further, our Company may also grant additional options to Employees pursuant to the ESOP Scheme during the period commencing from filing of the Draft Red Herring Prospectus with SEBI until the Equity Shares are listed on the Stock Exchanges or all application monies have been refunded, as the case may be.

## SECTION IV – PARTICULARS OF THE OFFER

### OBJECTS OF THE OFFER

The Offer comprises the Offer for Sale and the Fresh Issue, aggregating up to ₹ 7,620.00 million.

#### Offer for Sale

The proceeds of the Offer for Sale shall be received by the Selling Shareholders. Our Company will not receive any proceeds from the Offer for Sale. The Selling Shareholders will be entitled to their pro rata proceeds from the Offer for Sale, net of their respective portion of the Offer related expenses and relevant taxes thereon. For further details, please see “- Offer Expenses” on page 95.

#### Fresh Issue

Our Company proposes to utilise the Net Proceeds from the Fresh Issue towards funding the following objects:

1. Repayment/pre-payment, in full or in part, of certain borrowings availed by our Company and Subsidiaries; and
2. General corporate purposes.

(collectively referred to herein as “Objects”)

In addition to the aforementioned Objects, our Company expects that the listing of the Equity Shares will enhance our visibility and our brand image among our existing and potential customers and creation of a public market for our Equity Shares. The main objects and objects incidental and ancillary to the main objects set out in the Memorandum of Association enable us (i) to undertake our existing business activities and (ii) to undertake the activities proposed to be funded from the Net Proceeds, as well as the activities towards which the loans proposed to be repaid or pre-paid from the Net Proceeds were utilised.

#### Net Proceeds

The details of the proceeds from the Fresh Issue are summarised in the following table:

(in ₹ million)

Particulars	Estimated amount <sup>^</sup>
Gross proceeds of the Fresh Issue	1,500.00
(Less) Expenses in relation to the Fresh Issue <sup>(1)</sup>	[●]
Net Proceeds <sup>(1)</sup>	[●]

<sup>(1)</sup> To be finalised upon determination of the Offer Price and updated in the Prospectus prior to filing with the RoC

<sup>^</sup> Includes the proceeds, if any, received pursuant to the Pre-IPO Placement. Upon allotment of Equity Shares issued pursuant to the Pre-IPO Placement, we may utilise the proceeds from such Pre-IPO Placement towards the Objects of the Offer.

#### Utilisation of Net Proceeds

The Net Proceeds are proposed to be utilised in accordance with the details provided in the following table:

(in ₹ million)

Particulars	Estimated amount <sup>^</sup>
Repayment/pre-payment, in full or in part, of certain borrowings availed by our Company and Subsidiaries	1,200.00
General corporate purposes <sup>(1)</sup>	[●]
<b>Total<sup>(1)</sup></b>	<b>[●]</b>

<sup>(1)</sup> To be finalised upon determination of the Offer Price and updated in the Prospectus prior to filing with the RoC. The amount utilised for general corporate purposes shall not exceed 25% of the gross proceeds from the Fresh Issue.

<sup>^</sup> Includes the proceeds, if any, received pursuant to the Pre-IPO Placement. Upon allotment of Equity Shares issued pursuant to the Pre-IPO Placement, we may utilise the proceeds from such Pre-IPO Placement towards the Objects of the Offer.

#### Proposed schedule of implementation and deployment of Net Proceeds

We propose to deploy the Net Proceeds towards the Objects in accordance with the estimated schedule of implementation and deployment of funds as follows:

(in ₹ million)

Particulars	Amount to be funded from Net Proceeds	Estimated deployment of the Net Proceeds
		Fiscal 2023
Repayment/pre-payment, in full or in part, of certain borrowings availed by our Company and Subsidiaries	1,200.00	1,200.00
General corporate purposes <sup>(1)</sup>	[●]	[●]
<b>Total<sup>(1)</sup></b>	[●]	[●]

<sup>(1)</sup>To be finalised upon determination of the Offer Price and updated in the Prospectus prior to filing with the RoC. The amount utilised for general corporate purposes shall not exceed 25% of the gross proceeds from the Fresh Issue. Our Company and the Selling Shareholders, in consultation with the BRLMs, may consider the Pre-IPO Placement aggregating up to ₹ 300.00 million. If the Pre-IPO Placement is completed, the size of the Fresh Issue will be reduced to the extent of such Pre-IPO Placement, subject to the Offer constituting at least [●]% of the post-Offer paid up Equity Share capital of our Company.

The fund requirements, deployment of funds and the intended use of the Net Proceeds as described in this Draft Red Herring Prospectus are based on our current business plan, management estimates and other commercial and technical factors. However, such fund requirements and deployment of funds have not been appraised by any bank, or financial institution. We may have to revise these estimates on account of a variety of factors such as our financial and market condition, business and strategy, competition and other external factors such as changes in the business environment and interest or exchange rate fluctuations, which may not be within the control of our management. Further, our Company's funding requirements and deployment schedules for the reduction of outstanding borrowings as stated hereinabove, are subject to revision in the future at the discretion of our management. See "Risk Factors – Our funding requirements and the proposed deployment of Net Proceeds have not been appraised by any bank or financial institution or any other independent agency and our management will have broad discretion over the use of the Net Proceeds." on page 48.

Our Company proposes to deploy the entire Net Proceeds towards the aforementioned objects during Fiscal 2023. In the event that the estimated utilization of the Net Proceeds in a scheduled fiscal year is not completely met due to the reasons stated above, such funds shall be utilised in the next fiscal year, as may be determined by our Company, in accordance with applicable law. In case the actual utilisation towards any of the Objects is lower than the proposed deployment such balance will be used towards general corporate purposes to the extent that the total amount to be utilised towards general corporate purposes will not exceed 25% of the gross proceeds in accordance with the SEBI ICDR Regulations.

## Means of Finance

No amounts are proposed to be raised through any other means of finance and the entire requirement of funds for the Objects of the Fresh Issue are proposed to be met from the Net Proceeds. Accordingly, we confirm that there is no requirement for us to make firm arrangements of finance as prescribed under Regulation 7(1)(e) of the SEBI ICDR Regulations and Paragraph 9(C)(1) of Part A of Schedule VIII of the SEBI ICDR Regulations. In case of a shortfall in the Net Proceeds or any increase in the actual utilisation of funds earmarked for the Objects, our Company may explore a range of options including utilizing our internal accruals and/or seeking additional debt from existing and/or other lenders.

## Details of the Objects of the Fresh Issue

### 1. Repayment/pre-payment, in full or in part, of certain borrowings availed by our Company and its Subsidiaries

We avail majority of our fund-based and non-fund-based facilities in the ordinary course of business from various banks and financial institutions, in the form of working capital loans and vehicle loans. For further information on the financial indebtedness of our Company, see "Financial Indebtedness" on page 311. As of September 30, 2021, we had total borrowings of ₹ 4,088.43 million. We propose to utilise a portion of the Net Proceeds aggregating to ₹ 1,200.00 million for full or partial repayment or prepayment of all or a portion of the principal amount on certain loans availed by our Company and Subsidiaries and the accrued interest thereon in the case of certain loans availed by our Company and Subsidiaries.

Pursuant to the terms of the borrowing arrangements, prepayment of certain indebtedness may attract prepayment charges as prescribed by the respective lender. Such prepayment charges, as applicable, will also be funded out of the Net Proceeds. Given the nature of the borrowings and the terms of repayment or prepayment, the aggregate

outstanding amounts under the borrowings may vary from time to time and we may, in accordance with the relevant repayment schedule, repay or refinance some of their existing borrowings prior to Allotment. Accordingly, our Company may utilise the Net Proceeds for repayment/prepayment of any such refinanced facilities (including any prepayment fees or penalties thereon) or any additional facilities obtained by our Company and its Subsidiaries. However, the aggregate amount to be utilised from the Net Proceeds towards prepayment or repayment of borrowings (including refinanced or additional facilities availed, if any), in part or full, will not exceed ₹ 1,200 million. We believe that such repayment or prepayment will help reduce our outstanding indebtedness on a consolidated basis and debt servicing costs and enable utilization of the internal accruals for further investment towards business growth and expansion. In addition, the improvement in the debt-to-equity ratio of our Company is intended to enable us to raise further resources in the future to fund potential business development opportunities and plans to grow and expand our business in the future.

The selection of borrowings proposed to be prepaid or repaid amongst our borrowing arrangements availed will be based on various factors, including (i) cost of the borrowing, including applicable interest rates, (ii) any conditions attached to the borrowings restricting our ability to prepay/ repay the borrowings and time taken to fulfil, or obtain waivers for fulfilment of such conditions, (iii) receipt of consents for prepayment from the respective lenders, (iv) terms and conditions of such consents and waivers, (v) levy of any prepayment penalties and the quantum thereof, (vi) provisions of any laws, rules and regulations governing such borrowings, and (vii) other commercial considerations including, among others, the amount of the loan outstanding and the remaining tenor of the loan. We will approach the relevant lenders after completion of this Offer for repayment/prepayment of the borrowings.

The details of the outstanding loans proposed for repayment or prepayment, in full or in part from the Net Proceeds are set forth below:

(₹ in million)

Sr. No.	Name of the lender <sup>(1)</sup>	Nature of loan <sup>(1)</sup>	Purpose of loan availed as per loan agreement <sup>(1)</sup>	Sanctioned amount (in ₹ million) <sup>(1)</sup>	Amount outstanding as at September 30, 2021 <sup>(1)</sup>	Interest rate* (%)	Repayment schedule	Prepayment Penalty
<b>Our Subsidiaries</b>								
<b>LAPL</b>								
1.	Kotak Mahindra Prime Limited	Working Capital	Inventory funding – Cars	450.00	316.67	7.95%	In case of sale of vehicle by the Dealer, the amount has to be repaid forthwith to Kotak Mahindra Prime Limited (“KMPL”) subject however that in case of any credit sales against the delivery order of the recognized financiers (as determined by KMPL), the payment shall have to be made to KMPL within a maximum period of five days from the date of delivery order or actual delivery of the vehicle, whichever is earlier. If delivery order is realized before five days, the payment has to be done forthwith	Nil <sup>(2)</sup>
2.	Kotak Mahindra Prime Limited	Working Capital	Inventory funding – Spares	47.50	20.83	9.50%	In case of sale of vehicle by the Dealer, the amount has to be repaid forthwith to Kotak Mahindra Prime Limited (“KMPL”) subject however that in case of any credit sales	Nil <sup>(2)</sup>

Sr. No.	Name of the lender <sup>(1)</sup>	Nature of loan <sup>(1)</sup>	Purpose of loan availed as per loan agreement <sup>(1)</sup>	Sanctioned amount (in ₹ million) <sup>(1)</sup>	Amount outstanding as at September 30, 2021 <sup>(1)</sup>	Interest rate* (%)	Repayment schedule	Prepayment Penalty
							against the delivery order of the recognized financiers (as determined by KMPL), the payment shall have to be made to KMPL within a maximum period of five days from the date of delivery order or actual delivery of the vehicle, whichever is earlier. If delivery order is realized before five days, the payment has to be done forthwith	
3.	HDFC Bank Ltd	Working Capital	Inventory funding	80.00	2.89	7.85%	In case of inventory facilities the borrower has to repay the funds as and when the stock is sold on pay as sold basis or the tranche period expires whichever is earlier. Any violation may result into blockage of limits.	Nil <sup>(3)</sup>
4.	HDFC Bank Ltd	Working Capital	Inventory funding - Spares	5.00	0.35	7.85%	In case of inventory facilities the borrower has to repay the funds as and when the stock is sold on pay as sold basis or the tranche period expires whichever is earlier. Any violation may result into blockage of limits.	Nil <sup>(3)</sup>
<b>BMPL</b>								
5.	Yes Bank	Working Capital	Inventory funding vehicles	25.00	24.75	9.19%	60 days	Nil
6.	Nissan Renault Financial Services India	Working Capital	Inventory funding - Cars	355.00	292.61	0-90days: 10.00% 91-180 days: 10.25%	Sold vehicles: Due immediately on retail. However, grace period of 10 days without penal charges is applicable if the dealer reports the retail in floor plan system. If the retail sale is not reported and if it is identified in stock audit, then the VIN/unit would be marked as SOT (Sale Out of Trust) with due for repayment immediately without grace days.	Nil

Sr. No.	Name of the lender <sup>(1)</sup>	Nature of loan <sup>(1)</sup>	Purpose of loan availed as per loan agreement <sup>(1)</sup>	Sanctioned amount (in ₹ million) <sup>(1)</sup>	Amount outstanding as at September 30, 2021 <sup>(1)</sup>	Interest rate* (%)	Repayment schedule	Prepayment Penalty
							Unsold vehicles: Immediate on due date (91st day/ 181st day/ curtailment due dates)	
7.	Nissan Renault Financial Services India	Working Capital	Inventory funding - Spares and accessories	20.00	15.10	11.75%	Sold vehicles: Due immediately on retail. However, grace period of 10 days without penal charges is applicable if the dealer reports the retail in floor plan system. If the retail sale is not reported and if it is identified in stock audit, then the VIN/unit would be marked as SOT (Sale Out of Trust) with due for repayment immediately without grace days.  Unsold vehicles: Immediate on due date (91st day/ 181st day/ curtailment due dates)	Nil
8.	Yes Bank	Working Capital	Inventory funding - Spares	10.00	8.44	9.19%	60 days	Nil
<b>LCVPL</b>								
9.	HDFC Bank Ltd	Working Capital	Commercial vehicle inventory funding	210.00	210.00	7.85%	Pay as sold basis or on expiry of tranche period, whichever is earlier	Nil <sup>(3)</sup>
<b>LLCPL</b>								
10.	HDFC Bank Ltd	Working Capital	Inventory funding	250.00	192.10	7.85%	In case of inventory facilities, the borrower has to repay the funds as & when the Stock is sold on pay as sold basis or the tranche period expires whichever is earlier. Any violation may result into blockage of limits.	Nil <sup>(3)</sup>
11.	HDFC Bank Ltd	Working Capital	Inventory funding - Spares	50.00	46.12	7.85%	In case of inventory facilities, the borrower has to repay the funds as & when the Stock is sold on pay as sold basis or the tranche period expires whichever is earlier. Any violation may result into blockage of limits.	Nil <sup>(3)</sup>
12.	Kotak Mahindra Prime Limited	Working Capital	Inventory funding - Cars	450.00	363.15	7.95%	In case of sale of vehicle by the Dealer, the amount has to be repaid forthwith to Kotak Mahindra Prime	Nil <sup>(4)</sup>

Sr. No.	Name of the lender <sup>(1)</sup>	Nature of loan <sup>(1)</sup>	Purpose of loan availed as per loan agreement <sup>(1)</sup>	Sanctioned amount (in ₹ million) <sup>(1)</sup>	Amount outstanding as at September 30, 2021 <sup>(1)</sup>	Interest rate* (%)	Repayment schedule	Prepayment Penalty
							Limited (“KMPL”) subject however that in case of any credit sales against the delivery order of the recognized financiers (as determined by KMPL), the payment shall have to be made to KMPL within a maximum period of five days from the date of delivery order or actual delivery of the vehicle, whichever is earlier. If delivery order is realized before five days, the payment has to be done forthwith.	

\*As on the date of this Draft Red Herring Prospectus.

- (1) Our Statutory Auditor have issued its report on factual findings dated January 18, 2022 (“AUP”), in accordance with Indian Standard on Related Services (SRS) 4400, “Engagements to Perform Agreed-upon Procedures regarding Financial Information”, issued by the Institute of Chartered Accountants of India wherein they have stated that they have obtained the details of loans availed and traced the amount of outstanding loan as at September 30, 2021 to the books of accounts of the Company as at September 30, 2021 and found such amounts to be in agreement.
- (2) If LAPL intends to terminate the agreement(s) with Kotak Mahindra Prime Limited after completion of the first twelve months and up to twenty fourth month from the date of disbursement of facilities, LAPL shall pay to Kotak Mahindra Prime Limited prepayment interest at 3.0% on the entire sanctioned amount as on date of receipt of termination request from LAPL. The prepayment interest shall be at 2.0%, on the facility sanctioned amount as on date of receipt of termination request from LAPL, after completion of 24 months from the date of disbursement of the facilities. The applicable government levies/ taxes will be extra.
- (3) Foreclosure charges at the rate of 4% per annum + taxes as applicable, shall apply on termination of the facility by the borrower.
- (4) If LLCPL intends to terminate the agreement(s) with Kotak Mahindra Prime Limited after completion of the first twelve months and up to twenty fourth month from the date of disbursement of facilities, LLCPL shall pay to Kotak Mahindra Prime Limited prepayment interest at 3.0% on the entire sanctioned amount as on date of receipt of termination request from LLCPL. The prepayment interest shall be at 2.0%, on the facility sanctioned amount as on date of receipt of termination request from LLCPL, after completion of 24 months from the date of disbursement of the facilities. The applicable government levies/ taxes will be extra.

In the event, our Company deploys the Net Proceeds in any of our Subsidiaries for the purpose of prepayment or repayment of all or a portion of the abovementioned borrowings, it shall be in the form of equity or debt or in any other manner as may be mutually decided. The actual mode of such deployment has not been finalised as on the date of this Draft Red Herring Prospectus.

In addition to the above, we may, from time to time, enter into further borrowing arrangements and draw down funds thereunder. In such cases or in case any of the above loans are prepaid, repaid, redeemed (earlier or scheduled), refinanced or further drawn-down prior to the completion of the Offer, we may utilize Net Proceeds of the Fresh Issue towards prepayment, repayment or redemption (earlier or scheduled) of such additional indebtedness availed by us, details of which shall be provided in the Red Herring Prospectus.

## 2. General Corporate Purposes

Our Company proposes to deploy the balance Net Proceeds aggregating to ₹ [●] million towards general corporate purposes and the business requirements of our Company as approved by the Board, from time to time, subject to such utilisation for general corporate purposes not exceeding 25% of the gross proceeds from the Fresh Issue, in compliance with the Regulation 7(2) of the SEBI ICDR Regulations.



The general corporate purposes for which our Company proposes to utilise Net Proceeds include *inter alia* brand building and marketing efforts, acquisition of fixed assets, meeting expenses incurred towards any strategic initiatives, partnerships, tie-ups, joint ventures or acquisitions, investment in our Subsidiaries, long-term or short-term working capital requirements, meeting exigencies and expenses incurred by our Company in the ordinary course of business. In addition to the above, our Company may utilise the Net Proceeds towards other expenditure (in the ordinary course of business) considered expedient and as approved periodically by our Board or a duly constituted committee thereof, subject to compliance with applicable law, including the necessary provisions of the Companies Act.

The quantum of utilisation of funds towards each of the above purposes will be determined by our Board, based on the amount available under this head and the business requirements of our Company, from time to time. Our Company's management, in accordance with the policies of the Board, shall have flexibility in utilising surplus amounts, if any. In the event that we are unable to utilise the entire amount that we have currently estimated for use out of Net Proceeds in a Fiscal, we will utilise such unutilised amount in the next Fiscal.

### Offer Expenses

The total expenses of the Offer are estimated to be approximately ₹ [●] million. The expenses of this Offer include, among others, listing fees, selling commission and brokerage, fees payable to the BRLMs, fees payable to legal counsel, fees payable to the Registrar to the Offer, Escrow Bank(s) and Sponsor Bank to the Offer, processing fee to the SCSBs for processing application forms, brokerage and selling commission payable to members of the Syndicate, Registered Brokers, CRTAs and CDPs, printing and stationery expenses, advertising and marketing expenses and all other incidental and miscellaneous expenses for listing the Equity Shares on the Stock Exchanges.

Other than (a) listing fees and annual audit fees which will be borne by our Company, and (b) the fees and expenses in relation to the legal counsel to the Selling Shareholders which shall be borne by the respective Selling Shareholders, all costs, charges, fees and expenses associated with and incurred in connection with the Offer shall be shared among the Company and each of the Selling Shareholders, in proportion to the number of Equity Shares issued and Allotted through the Fresh Issue and sold by each of the Selling Shareholders in the Offer for Sale. Provided that all such payments shall be made by our Company on behalf of the Selling Shareholders and upon the successful completion of the Offer, the Selling Shareholders agree that they shall, severally and not jointly, reimburse our Company in proportion to their respective proportion of the Offered Shares, for any expenses incurred by our Company on behalf of such Selling Shareholder. In the event the Offer is withdrawn or not completed for any reason whatsoever by way of mutual agreement between our Company and the Selling Shareholders or the Offer is not successful, all costs and expenses with respect to the Offer shall be borne by our Company.

The break-down of the estimated Offer expenses are set forth in the table below:

Activity	<i>(in ₹ million)</i>		
	Estimated expenses*	As a % of the total estimated Offer expenses	As a % of the total Offer size
Fees payable to the BRLMs and commissions (including underwriting commission, brokerage and selling commission)	[●]	[●]	[●]
Commission/processing/uploading fee for SCSBs, Sponsor Bank and Bankers to the Offer. Brokerage, underwriting commission and selling commission and bidding charges for Members of the Syndicate, Registered Brokers, CRTAs and CDPs <sup>(1)(2)</sup>	[●]	[●]	[●]
Fees payable to the Registrar to the Offer	[●]	[●]	[●]
Advertising and marketing expenses	[●]	[●]	[●]
Fees payable to the other advisors to the Offer	[●]	[●]	[●]
Others			
i. Listing fees, SEBI, BSE and NSE processing fees, book building software fees and other regulatory expenses;	[●]	[●]	[●]
ii. Printing and distribution of stationery;	[●]	[●]	[●]
iii. Fees payable to legal counsels; and	[●]	[●]	[●]
iv. Miscellaneous.	[●]	[●]	[●]
<b>Total estimated Offer expenses</b>	[●]	[●]	[●]

\* Offer expenses include goods and services tax, where applicable. Offer expenses will be incorporated at the time of filing of the Prospectus. Offer expenses are estimates and are subject to change

(1) Selling commission payable to SCSBs, on the portion for Retail Individual Investors and Non-Institutional Investors which are directly procured by the SCSBs, would be as follows:

Portion for Retail Individual Investors*	[●]% of the Amount Allotted (plus applicable taxes)
Portion for Non-Institutional Investors*	[●]% of the Amount Allotted (plus applicable taxes)

\* Amount Allotted is the product of the number of Equity Shares Allotted and the Offer Price

(2) No uploading/processing fees shall be payable by our Company and the Selling Shareholders to the SCSBs on the applications directly procured by them. Processing fees payable to the SCSBs on the portion for Retail Individual Investors and Non-Institutional Investors which are procured by the members of the Syndicate/sub-Syndicate/Registered Broker/CRTAs/ CDPs and submitted to SCSB for blocking, would be as follows:

Portion for Retail Individual Investors	₹ [●] per valid application (plus applicable taxes)
Portion for Non-Institutional Investors	₹ [●] per valid application (plus applicable taxes)

(3) The processing fees for applications made by Retail Individual Investors using the UPI Mechanism would be as follows:

Sponsor Bank	₹ [●] per valid Bid cum Application Form* (plus applicable taxes)  The Sponsor Bank shall be responsible for making payments to the third parties such as remitter bank, NCPI and such other parties as required in connection with the performance of its duties under the SEBI circulars, the Syndicate Agreement and other applicable law
--------------	--

\* For each valid application

(4) Selling commission on the portion for Retail Individual Investors and Non-Institutional Investors which are procured by members of the Syndicate (including their sub-Syndicate Members), Registered Brokers, CRTAs and CDPs or for using 3-in-1 type accounts- linked online trading, demat & bank account provided by some of the Registered Brokers which are Members of the Syndicate (including their Sub-Syndicate Members) would be as follows:

Portion for Retail Individual Investors*	[●]% of the Amount Allotted (plus applicable taxes)
Portion for Non-Institutional Investors*	[●]% of the Amount Allotted (plus applicable taxes)

\* Amount Allotted is the product of the number of Equity Shares Allotted and the Offer Price

Uploading charges payable to Members of the Syndicate (including their sub-Syndicate Members), CRTAs and CDPs on the applications made by RIIs using 3-in-1 accounts, Eligible Employees and Non-Institutional Investors which are procured by them and submitted to SCSB for blocking or using 3-in- 1 accounts, would be as follows: ₹ [●] plus applicable taxes, per valid application bid by the Syndicate (including their sub-Syndicate Members), CRTAs and CDPs.

The Selling Commission payable to the Syndicate / Sub-Syndicate Members will be determined on the basis of the application form number / series, provided that the application is also bid by the respective Syndicate / Sub-Syndicate Member. For clarification, if a Syndicate ASBA application on the application form number / series of a Syndicate / Sub-Syndicate Member, is bid by an SCSB, the Selling Commission will be payable to the SCSB and not the Syndicate / Sub-Syndicate Member.

(5) Bidding Charges payable to members of the Syndicate (including their sub-Syndicate Members), CRTAs and CDPs on the portion for RIIs and Non-Institutional Investors which are procured by them and submitted to SCSB for blocking, would be as follows: ₹ [●] plus applicable taxes, per valid application bid by the Syndicate (including their sub-Syndicate Members), CRTAs and CDPs.

The selling commission and bidding charges payable to Registered Brokers the CRTAs and CDPs will be determined on the basis of the bidding terminal id as captured in the Bid Book of BSE or NSE.

Bidding charges payable to the Registered Brokers, CRTAs/CDPs on the portion for RIIs, Eligible Employees and Non-Institutional Investors which are directly procured by the Registered Broker or CRTAs or CDPs and submitted to SCSB for processing, would be as follows:

Portion for Retail Individual Investors*	[●]% of the Amount Allotted (plus applicable taxes)
Portion for Non-Institutional Investors*	[●]% of the Amount Allotted (plus applicable taxes)

\* Based on valid applications

All such commissions and processing fees set out above shall be paid as per the timelines in terms of the Syndicate Agreement and Escrow and Sponsor Bank Agreement.

The processing fees for applications made by Retail Individual Investors using the UPI Mechanism may be released to the remitter banks (SCSBs) only after such banks provide a written confirmation on compliance with SEBI Circular No: SEBI/HO/CFD/DIL2/P/CIR/P/2021/750 dated June 2, 2021 read with SEBI Circular No: SEBI/HO/CFD/DIL2/P/CIR/P/2021/2480/1/M dated March 16, 2021.

### **Interim use of funds**

The Net Proceeds shall be retained in the Public Offer Account until receipt of the listing and trading approvals from the Stock Exchanges by our Company. Pending utilization for the purposes described above, we will temporarily invest the funds from the Net Proceeds in deposits only with one or more scheduled commercial banks included in the second schedule of the Reserve Bank of India Act, 1934, as amended. In accordance with Section 27 of the Companies Act 2013, our Company confirms that it shall not use the Net Proceeds for buying, trading or otherwise dealing in shares of any other listed company or for any investment in the equity markets.

### **Bridge loan**

Our Company has not raised any bridge loans from any banks or financial institutions, which are proposed to be repaid from the Net Proceeds, as on the date of this Draft Red Herring Prospectus.

### **Monitoring of utilisation of funds**

In accordance with Regulation 41 of the SEBI ICDR Regulations, our Company shall appoint a Monitoring Agency for monitoring the utilization of Net Proceeds prior to the filing of the Red Herring Prospectus, as the Fresh Issue size exceeds ₹ 1,000 million. Our Audit Committee and the Monitoring Agency will monitor the utilization of the Net Proceeds. Our Company undertakes to place the report(s) of the Monitoring Agency on receipt before the Audit Committee without any delay. Our Company will disclose the utilization of the Net Proceeds, including interim use under a separate head in its balance sheet for such fiscal periods as required under the SEBI ICDR Regulations, the SEBI Listing Regulations and any other applicable laws or regulations, clearly specifying the purposes for which the Net Proceeds have been utilized. Our Company will also, in its balance sheet for the applicable fiscal periods, provide details, if any, in relation to all such Net Proceeds that have not been utilized, if any, of such currently unutilized Net Proceeds.

Pursuant to Regulation 18(3) and Regulation 32(3) of the SEBI Listing Regulations, our Company shall, on a quarterly basis, disclose to the Audit Committee the uses and applications of the Net Proceeds. On an annual basis, our Company shall prepare a statement of funds utilized for purposes other than those stated in this Draft Red Herring Prospectus and place it before the Audit Committee and make other disclosures as may be required until such time as the Net Proceeds remain unutilized. Such disclosure shall be made only until such time that all the Net Proceeds have been utilized in full. The statement shall be certified by the statutory auditor of our Company. Furthermore, in accordance with Regulation 32(1) of the SEBI Listing Regulations, our Company shall furnish to the Stock Exchanges on a quarterly basis, a statement indicating (i) deviations, if any, in the actual utilization of the proceeds of the Fresh Issue from the objects of the Fresh Issue as stated above; and (ii) details of category wise variations in the actual utilization of the proceeds of the Fresh Issue from the objects of the Fresh Issue as stated above. This information will also be uploaded onto our website.

### **Variation in objects**

In accordance with Sections 13(8) and 27 of the Companies Act 2013, our Company shall not vary the Objects of the Offer unless our Company is authorized to do so by way of a special resolution of its Shareholders and such variation will be in accordance with the applicable laws including the Companies Act 2013 and the SEBI ICDR Regulations. In addition, the notice issued to the Shareholders in relation to the passing of such special resolution (“**Postal Ballot Notice**”) shall specify the prescribed details as required under the Companies Act 2013 and applicable rules. The Postal Ballot Notice shall simultaneously be published in the newspapers, one in English and one in Gujarati, being the regional language of Gujarat, where our Registered Office is situated in accordance with the Companies Act and applicable rules. Our Promoter will be required to provide an exit opportunity to such Shareholders who do not agree to the proposal to vary the objects, at such price, and in such manner, in accordance with Section 13(8) and other applicable provisions of the Companies Act 2013, our Articles of Association, and the Regulation 59 of SEBI ICDR Regulations.

### **Appraising entity**

None of the objects of the Offer for which the Net Proceeds will be utilised have been appraised by any bank/ financial institution.

**Other confirmations**

Except to the extent of the proceeds received by the Sanjay Karsandas Thakker HUF and Garima Misra pursuant to the Offer for Sale, none of our Promoter or members of the Promoter Group, Directors or Key Managerial Personnel will receive any portion of the proceeds from the Offer Proceeds. There is no existing or anticipated interest of such individuals and entities in the objects of the Fresh Issue as set out above.

## BASIS FOR THE OFFER PRICE

The Price Band, Floor Price and Offer Price will be determined by our Company and the Selling Shareholders, in consultation with the Book Running Lead Managers, on the basis of assessment of market demand for the Equity Shares offered through the Book Building Process and on the basis of the quantitative and qualitative factors described below. Investors should also refer to “Our Business”, “Risk Factors”, “Restated Consolidated Financial Information” and “Management’s Discussion and Analysis of Financial Position and Results of Operations” on pages 133, 28, 202 and 272, respectively, to have an informed view before making an investment decision.

### Qualitative factors

Some of the qualitative factors which form the basis for computing the Offer Price are:

- (a) Leading automotive dealership for major OEMs with a strong focus on high growth segments;
- (b) Growing presence in after-sales segment leading predictable growth in revenues and superior margins;
- (c) Comprehensive business model capturing entire customer value-chain; and
- (d) Robust business processes leveraging technological innovation and digitalization.

For further details, see “Risk Factors” and “Our Business- Our Strengths” on pages 28 and 136, respectively.

### Quantitative factors

Some of the information presented below relating to our Company is derived from the Restated Consolidated Financial Information. For details, see “Restated Consolidated Financial Information” on page 202.

Some of the quantitative factors which may form the basis for calculating the Offer Price are as follows:

#### I. Basic and diluted earnings per share (“EPS”)

Financial Period	Basic EPS (₹)	Diluted EPS (₹)	Weight
Fiscal 2021	3.09	3.05	3
Fiscal 2020	(7.84)	(7.84)	2
Fiscal 2019	(7.01)	(7.00)	1
<b>Weighted Average</b>	(2.24)	(2.26)	
Six months period ended September 30, 2021*	7.58	7.40	

\*Not annualised

Notes:

1. The face value of each Equity Share is ₹ 5 each.
2. Basic EPS (₹) = Basic earnings per share are calculated by dividing the Restated Net Profit/(loss) after tax for the year/ period attributable to equity shareholders of the Company by the weighted average number of equity Shares outstanding during the year/period post sub-division of equity shares.
3. Diluted EPS (₹) = Diluted earnings per share are calculated by dividing the Net Restated Profit/(loss) after tax for the year/period attributable to equity shareholders of the Company by the weighted average number of equity Shares outstanding during the year/period adjusted for the effects of all dilutive potential equity shares post sub-division of equity shares.  
Basic EPS and Diluted EPS calculations are in accordance with Indian Accounting Standard 33 ‘Earnings per Share’.
4. Weighted average number of Equity Shares is the number of Equity Shares outstanding at the beginning of the year/ period adjusted by the number of Equity Shares issued during the year/ period multiplied by the time weighting factor. The time weighting factor is the number of days for which the specific shares are outstanding as a proportion of total number of days during the period.
5. Weighted average = Aggregate of year-wise weighted EPS divided by the aggregate of weights i.e. [(EPS x Weight) for each year] / [Total of weights]
6. The above statement should be read with significant accounting policies and notes on Restated Consolidated Financial Information as appearing in the section titled “Financial Information – Restated Consolidated Financial Information” on page 202.

#### II. Price/Earning (“P/E”) ratio in relation to Price Band of ₹[●] to ₹[●] per Equity Share:

Particulars	P/E at the lower end of the Price Band (number of times)*	P/E at the higher end of the Price Band (number of times)*
Based on basic EPS for Fiscal 2021	[●]	[●]
Based on diluted EPS for Fiscal 2021	[●]	[●]

\*will be populated in the Prospectus

### Industry Peer Group P/E ratio

There are no listed entities in India whose business portfolio is comparable with that of our business.

### III. Return on Net Worth (“RoNW”) derived from Restated Consolidated Financial Information:

Financial period	RoNW (%)	Weight
Fiscal 2021	6.23	3
Fiscal 2020	(16.99)	2
Fiscal 2019	(13.44)	1
<b>Weighted Average</b>	<b>(4.79)</b>	
Six months period ended September 30, 2021*	13.32	

\*Not annualised

#### Notes:

1. “Net worth means the aggregate value of the paid-up share capital and other equity.
2. Return on Net worth attributable to the owners of the company (%) = Restated Profit/(loss) after tax for the year/period attributable to equity holders of the company by restated total equity attributable to the equity holders of the Parent. Return on Net worth attributable to the owners of the company is a non-GAAP measure (see “Management’s Discussion and Analysis of Financial Position and Results of Operations – Key Performance Indicators and Non-GAAP Measures” on page 289, for the reconciliation of Return of Net worth attributable to the owners of the company calculated from the Restated Consolidated Financial Information).
3. Weighted average = Aggregate of year-wise weighted Return on Net worth attributable to the owners of the company divided by the aggregate of weights i.e. [(Return on Net worth attributable to the owners of the company x Weight) for each year] / [Total of weights].

### IV. Net asset value per Equity Share (Face Value of ₹ 5 each)

Net Asset Value per Equity Share	(₹)
As on March 31, 2021	49.62
As on September 30, 2021	56.93
After the completion of the Offer	At the Floor Price: [●] At the Cap Price: [●]
Offer Price	[●]

#### Notes:

1. Offer Price per Equity Share will be determined on conclusion of the Book Building Process.
2. Weighted average number of equity Shares is the number of equity Shares outstanding at the beginning of the year/ period adjusted by the number of Equity Shares issued during the year multiplied by the time weighting factor. The time weighting factor is the number of days for which the specific shares are outstanding as a proportion of total number of days during the year.
3. Net Asset Value Per Equity Share = Restated total equity attributable to the equity holders of the Parent / Weighted average number of equity shares outstanding during the year / period. Net Asset Value is a non-GAAP measure (see “Management’s Discussion and Analysis of Financial Position and Results of Operations - Non-GAAP Measures” on page 304 for the reconciliation of Net Asset Value calculated from the Restated Consolidated Financial Information).

### V. Comparison with listed industry peers

There are no listed companies in India that engage in a business similar to that of our Company. Accordingly, it is not possible to provide an industry comparison in relation to our Company.

### VI. The Offer Price is [●] times of the face value of the Equity Shares.

The Offer Price of ₹ [●] has been determined by our Company and the Selling Shareholders in consultation with the BRLMs, on the basis of assessment of demand from investors for Equity Shares through the Book Building Process and, is justified in view of the above qualitative and quantitative parameters.

Investors should read the above-mentioned information along with “Risk Factors”, “Our Business”, “Management Discussion and Analysis of Financial Position and Results of Operations” and “Financial Information” on pages 28, 133, 272 and 202, respectively, to have a more informed view.

The trading price of the Equity Shares could decline due to the factors mentioned in the “Risk Factors” on 28 and you may lose all or part of your investments.

## STATEMENT OF SPECIAL TAX BENEFITS

### STATEMENT OF SPECIAL TAX BENEFITS AVAILABLE TO LANDMARK CARS LIMITED, ITS MATERIAL SUBSIDIARIES AND THE SHAREHOLDERS OF THE COMPANY UNDER THE APPLICABLE TAX LAWS IN INDIA

Date: January 18, 2022

To,

**The Board of Directors,  
Landmark Cars Limited**  
Landmark House  
Opposite AEC, SG Highway  
Thaltej, Near Gurudwara  
Ahmedabad 380 059  
Gujarat, India

**Subject: Statement of Possible Special Tax Benefits available to Landmark Cars Limited (“the Company”), its Material Subsidiaries (as defined below) and the shareholders of the company under the direct and indirect tax laws**

Dear Sirs,

We refer to the proposed initial public offering of equity shares of the Company (the “Offer”). We enclose herewith the statement (the “Annexure”) showing the current position of special tax benefits available to the Company and the shareholders of the Company as per the provisions of the Indian direct and indirect tax laws, including the Income Tax Act 1961, the Central Goods and Services Tax Act, 2017, the Integrated Goods and Services Tax Act, 2017, the Union Territory Goods and Services Tax Act, 2017, respective State Goods and Services Tax Act, 2017 (collectively the “GST Act”), the Customs Act, 1962 (“Customs Act”) and the Customs Tariff Act, 1975 (“Tariff Act”) (collectively the “Taxation Laws”), including the rules, regulations, circulars and notifications issued in connection with the Taxation Laws, each as amended, and the Foreign Trade Policy 2015-2020 (which has been extended up to 31 March 2022 vide Notification no 33/2015-2020 dated 28 September 2021) and also to the material subsidiaries of the Company (as defined under the Securities and Exchange Board of India (Listing Obligations and Disclosure Requirements) Regulations, 2015, as amended, namely (i) Landmark Lifestyle Cars Private Limited (ii) Automark Motors Private Limited (iii) Benchmark Motors Private Limited (iv) Landmark Automobiles Private Limited and (v) Landmark Commercial Vehicles Private Limited (collectively, the “Material Subsidiaries”), as presently in force and applicable to the assessment year 2022-23 relevant to the financial year 2021-22 for inclusion in the Draft Red Herring Prospectus (“DRHP”) to be filed in connection with the Offer, as required under the Securities and Exchange Board of India (Issue of Capital and Disclosure Requirements) Regulations, 2018, as amended (“ICDR Regulations”).

The benefits discussed in the enclosed Annexure are neither exhaustive nor conclusive. The contents stated in the Annexure are based on the information and explanations obtained from the Company. This statement is only intended to provide general information to guide the investors and is neither designed nor intended to be a substitute for professional tax advice. In view of the individual nature of the tax consequences and the changing tax laws, each investor is advised to consult their own tax consultant with respect to specific tax implications arising out of their participation in the offer. We are neither suggesting nor are we advising the investor to invest money or not to invest money based on this statement.

We do not express any opinion or provide any assurance whether:

- The Company, its Material Subsidiaries or its Shareholders will continue to obtain these benefits in future;
- The conditions prescribed for availing the benefits have been/would be met;

We hereby give our consent to include this statement and the Annexure regarding the special tax benefits available to the Company, its Material Subsidiaries and the shareholders of the company in the DRHP to be filed in connection with the Offer with the Securities and Exchange Board of India and the stock exchanges where the equity shares of the Company are proposed to be listed, provided that the below statement of limitation is included in the DRHP.

## LIMITATIONS

Our views expressed in the Annexure are based on the facts and assumptions indicated above. No assurance is given that the revenue authorities/courts will concur with the views expressed herein. Our views are based on the existing provisions of law and its interpretation, which are subject to change from time to time. We do not assume responsibility to update the views consequent to such changes. Reliance on the Annexure is on the express understanding that we do not assume responsibility towards the investors who may or may not invest in the proposed offer relying on the Annexure.

This statement has been prepared solely in connection with the Offer under the ICDR Regulations.

For **Deloitte Haskins & Sells LLP**

Chartered Accountants

ICAI Firm Registration Number: 117366W/W - 100018

---

**Yogesh G Shah**

*Partner*

Membership No. 40260

Ahmedabad

Date: January 18, 2022

UDIN: 22040260AAAAAB7298



## **ANNEXURE TO THE STATEMENT OF SPECIAL TAX BENEFITS AVAILABLE TO THE COMPANY, ITS MATERIAL SUBSIDIARIES AND THE COMPANY'S SHAREHOLDERS**

The information provided below sets out the possible special tax benefits available to the Company, its material subsidiaries and the shareholders of the Company in a summary manner only and is not a complete analysis or listing of all potential tax consequences of the subscription, ownership and disposal of equity shares of the Company, under the current tax laws presently in force. These benefits are dependent on the shareholders fulfilling the conditions prescribed under the relevant tax laws. Hence the ability of the shareholders to derive the tax benefits is dependent upon fulfilling such conditions, which, based on commercial imperatives a shareholder faces, may or may not choose to fulfill. The following overview is not exhaustive or comprehensive and is not intended to be a substitute for professional advice. In view of the individual nature of the tax consequences and the changing tax laws, each investor is advised to consult their own tax consultant with respect to specific tax implications arising out of their participation in the issue. We are neither suggesting nor are we advising the investor to invest money or not to invest money based on this statement.

### **STATEMENT OF POSSIBLE DIRECT TAX BENEFITS AVAILABLE TO THE COMPANY, ITS MATERIAL SUBSIDIARIES AND TO THE SHAREHOLDERS OF THE COMPANY**

#### **Under the Income Tax Act, 1961 ("the Act")**

##### ***I. Special tax benefits available to the Company***

There are no special Direct Tax benefits available to the company under the provisions of the Act.

##### ***II. Special tax benefits available to Shareholders***

There are no special Direct Tax benefits available to the shareholders under the provisions of the Act.

##### ***III. Special tax benefits available to Material Subsidiaries***

There are no special Direct Tax benefits available to Material Subsidiaries of the company under the provisions of the Act.

### **STATEMENT OF POSSIBLE SPECIAL INDIRECT TAX BENEFITS AVAILABLE TO THE COMPANY, ITS MATERIAL SUBSIDIARIES AND SHAREHOLDERS OF THE COMPANY**

**The Central Goods and Services Tax Act, 2017, the Integrated Goods and Services Tax Act, 2017, the Union Territory Goods and Services Tax Act, 2017, respective State Goods and Services Tax Act, 2017, the Customs Act, 1962 and the Customs Tariff Act, 1975 including the rules, regulations, circulars and notifications issued in connection with the taxation laws and the Foreign Trade Policy 2015-2020 (which has been extended now by another one year i.e., up to 31st March 2022 vide Notification no 33/2015-2020 dated 28 September 2021) (collectively referred to as "Indirect tax").**

##### ***I. Special Indirect Tax benefits to the Company***

There are no special Indirect Tax benefits available to the Company.

##### ***II. Special Indirect Tax benefits available to Material Subsidiaries***

There are no special Indirect Tax benefits available to Material Subsidiaries of the Company.

##### ***III. Special Indirect Tax benefits available to Shareholders***

There are no special Indirect Tax benefits available to the shareholders of the Company.

#### **Notes:**

1. This statement does not discuss any tax consequences in the country outside India of an investment in the shares. The shareholders / investors in the country outside India are advised to consult their own professional advisors regarding possible Income tax consequences that apply to them.
2. The above statement of possible direct tax & indirect tax benefits sets out the provisions of law in a summary manner only and is not a complete analysis or listing of all potential tax consequences of the purchase, ownership and disposal of shares.

3. All the above benefits are as per the current tax law and any change or amendment in the laws/regulation, which when implemented would impact the same.
4. The special income-tax benefits are dependent on the Company, its Material Subsidiaries or its shareholders fulfilling the conditions prescribed under the relevant provisions of the Act. Hence, the ability of the Company, its Material Subsidiaries or its shareholders to derive the tax benefits is dependent upon fulfilling such prescribed conditions under the tax laws.
5. We have not considered general tax benefits available to the Company, its Material Subsidiaries or shareholders of the Company.

## SECTION V - ABOUT OUR COMPANY

### INDUSTRY OVERVIEW

The information contained in this section is derived from various industry and publicly available resources. The information also includes information available from the CRISIL Report. The CRISIL Report has been exclusively prepared for the purpose of the Offer, and is commissioned and paid-for by the Company. Industry sources and publications generally state that the information contained therein has been obtained from sources generally believed to be reliable, but that their accuracy, completeness and underlying assumptions are not guaranteed, and their reliability cannot be assured. Industry publications are also prepared on information as of specific dates and may no longer be current or reflect current trends. Accordingly, investment decisions should not be based on such information.

CRISIL Research, a division of CRISIL, has taken due care and caution in preparing the CRISIL Report based on the Information obtained by CRISIL from sources which it considers reliable ("Data"). The CRISIL Report is not a recommendation to invest / disinvest in any entity covered in the CRISIL Report and no part of the CRISIL Report should be construed as an expert advice or investment advice or any form of investment banking within the meaning of any law or regulation. CRISIL especially states that it has no liability whatsoever to the subscribers / users / transmitters/ distributors of the CRISIL Report. Without limiting the generality of the foregoing, nothing in the CRISIL Report is to be construed as CRISIL providing or intending to provide any services in jurisdictions where CRISIL does not have the necessary permission and/or registration to carry out its business activities in this regard. The Company will be responsible for ensuring compliances and consequences of non-compliances for use of the CRISIL Report or part thereof outside India. CRISIL Research operates independently of and does not have access to information obtained by CRISIL Ratings Limited / CRISIL Risk and Infrastructure Solutions Ltd (CRIS), which may, in their regular operations, obtain information of a confidential nature. The views expressed in the CRISIL Report are that of CRISIL Research and not of CRISIL Ratings Limited / CRIS. No part of the CRISIL Report may be published/reproduced in any form without CRISIL's prior written approval.

#### Overview of the global and Indian economy

##### Review of global economy

According to the CRISIL Report, as a result of the COVID-19 pandemic, the global real GDP contracted by 3.1% in 2019, after a 2.8% growth in 2018. According to the CRISIL Report, the global economy is projected to grow by 5.9% in 2021 and 4.9% in 2022. The IMF estimates of real GDP growth for key economies is set out below:

##### IMF estimates of real GDP growth for key economies

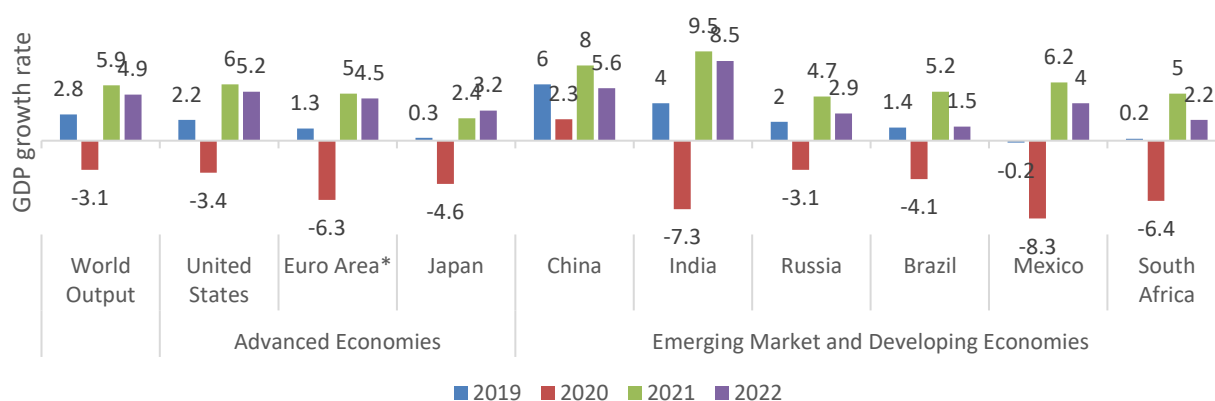

Note: \*Euro area includes Germany, France, Italy, Spain

Source: IMF (World Economic Outlook – October 2021 update), CRISIL Report

##### Overview of Indian economy

India was one of the fastest growing economies in the world prior to the COVID-19 pandemic, with annual growth of approximately 6.7% between calendar years 2014 and 2019 (Fiscal 2015 to Fiscal 2020). While the economic growth in calendar year 2020 contracted as a result of the economic slowdown led by the pandemic, CRISIL Research expects that, based on IMF's forecasts, India is likely to regain its reputation as one of the fastest growing economies globally over the 2021 and 2022 period. In view of the impact of the second wave of the pandemic, CRISIL Research expects the year-

on growth of Indian real GDP to be 9.5% for Fiscal 2022. Going forward, rapid urbanization, rising consumer aspiration and increasing digitization coupled with government support in the form of reforms and policies are expected to support economic growth.

### India's real GDP growth

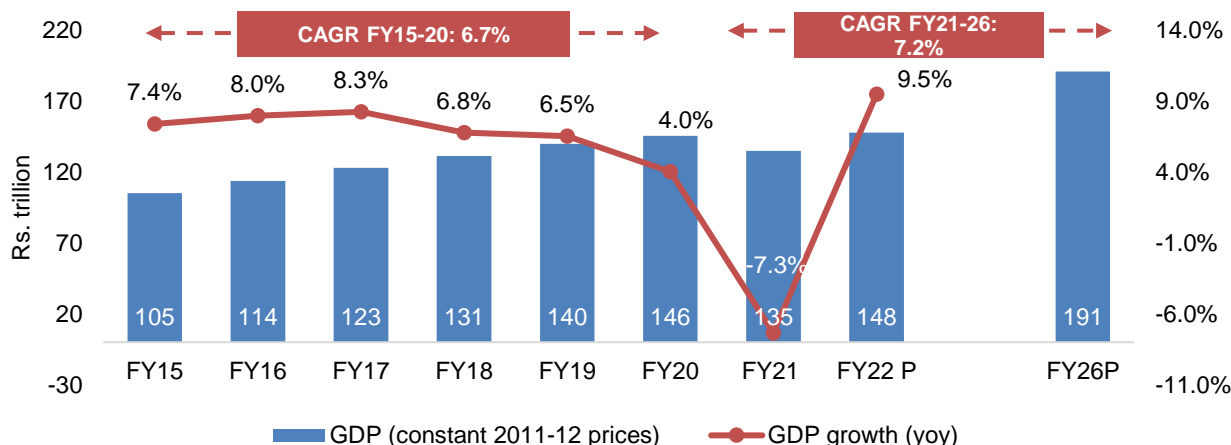

Note: P – Projected, FY21 – Provisional Estimates  
 Source: National Statistics Office (NSO), IMF, CRISIL Research estimates

According to the CRISIL Report, India's per-capita income (at constant prices), an enabler for domestic consumption, is expected to grow at a CAGR of 6.7% between Fiscal 2020 and Fiscal 2025.

Per capita income	Level in FY21 (INR- '000)		Growth at constant prices (%)									
	Current prices	Constant prices	FY13	FY14	FY15	FY16	FY17	FY18	FY19	FY20	FY21	FY25E
	146	100	3.3	4.6	6.2	6.7	6.8	5.7	5.8	3.1	-8.2	6.7*

Source: National accounts statistics 2021- MOSPI, CRISIL Research

### Automobile finance rates and loan disbursements

According to the CRISIL Report, yields in the auto finance segment in India have been declining over the past two to three years, due to softening of retail inflation and a fall in G-sec yields. In Fiscal 2021, passenger vehicle (PV) and commercial vehicle (CV) finance rates softened significantly due to the COVID-19 pandemic. Two-wheeler financing rates, however, dropped by a lesser extent, given the relatively humble credit profile of customers. CRISIL Research expects that the automobile finance rate to remain competitive in Fiscal 2022 with subdued repo rate. Lower automobile finance rate is expected to attract more buyer of vehicles, as attractive interest rates bring down the overall costs for vehicle buyers.

### Average auto finance rates offered by banks (%)

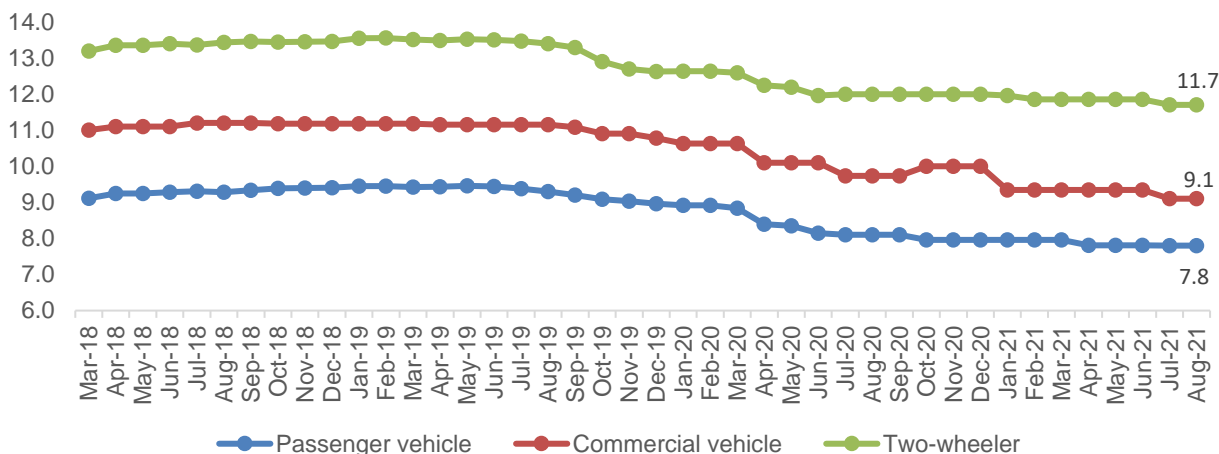

Source: Industry, CRISIL Research

Auto finance disbursement showed better-than-expected revival in the latter half of fiscal 2021. Most sub-segments witnessed underlying asset sales recovering to pre-Covid levels. As COVID-19 spreads through close contact between persons, the use of public transportation and shared mobility services were and is expected to be adversely impacted. Demand for person mobility has accordingly increased. Two-wheeler and small-car segments gained on account of pent-up demand and increased preference for personal mobility as lockdowns were lifted and people were wary of using public transport. In the CV segment, while sales of medium and heavy commercial vehicles (M&HCV) and buses remain tepid, that of light commercial vehicles (LCV) are improving.

In Fiscal 2022, a gradual improvement in consumer confidence on expectations of a faster economic growth is expected to revive vehicle sales. Consumer preference for own vehicle for personal mobility supported by lower financing costs and new model launches are also likely to support underlying demand for PVs. Overall, according to the CRISIL Report, PV loan disbursements are expected to witness a 20-25% growth in Fiscal 2022. For the CV segment, CV loan disbursements are expected to pick up as well economic recovery will lead to an increase in private consumption and freight demand. According to the CRISIL Report, new CV loan disbursements are projected to grow 30-35% in Fiscal 2022.

*YoY growth in auto finance disbursement (%)*

Segment	FY18	FY19	FY20	FY21	FY22E
PV – new	17%	9%	-9%	-15%	20-25%
CV – new	37%	22%	-36%	-28%	30-35%
Two-wheelers	31%	17%	-2%	-10%	13-18%

Source: Industry, CRISIL Research

**Review of the Indian passenger vehicle (PV) industry**

**Market Segments**

The Indian passenger vehicle industry can be broadly classified into three main segments, namely, mass market vehicles, premium vehicles and luxury vehicles.

Mass market vehicles segment mainly comprises of basic vehicles which are most economically friendly and preferred by the mass market in India. The mass market vehicles segment comprises of micro, mini, lower compact and vans segments. The share of mass market vehicles segment in the overall PV industry in India has decreased as a result of increasing disposable income, customer preference shifting towards premium vehicles and more frequent launches of new models in the premium vehicles segment.

Premium vehicles are costlier vehicles typically preferred by upper middle class and rich class. It comprises of upper compact, super compact, executive, premium and utility vehicles. This segment is getting more and more traction with increasing disposable incomes, higher launches and shifting customer preferences from mass market to premium vehicles.

Luxury vehicles segment is a niche segment offering high end vehicles at high premium prices, mainly preferred by high-net-worth individuals and organisations. Vehicles of Mercedes, BMW, Audi, Volvo and JLR are part of this segment. The share of ultraluxury market comprising of brands like Ferrari, Lamborghini, Bugatti, Rolls Royce is insignificant in India.

According to the CRISIL Report, in Fiscal 2016, mass market vehicles dominated the Indian PV industry with more than 60% market share. In the last five years, premium vehicles segment has grown at a healthy 8% CAGR, expanding its contribution from 38% in Fiscal 2016 to 56% in Fiscal 2021. On the other hand, mass market vehicle sales contracted at a CAGR of 7%, with its market share decreased from 62% in Fiscal 2016 to 44% in Fiscal 2021.

*PV industry split*

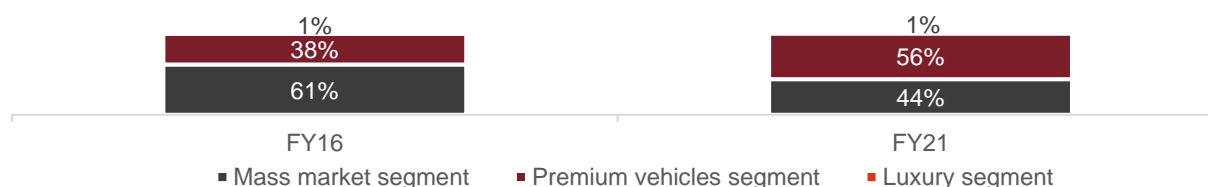

Note:

Mass market segment: SIAM classification micro, mini, lower compact and vans segments

Premium segment: SIAM classification upper compact, super compact, executive, premium and utility vehicles

Luxury segment: Highly Premium vehicles offered by Mercedes, Audi, BMW, JLR, Volvo.

Source: SIAM- Society of Indian Automobile Manufacturers, CRISIL Research

### Historical sales of the mass and premium segments

According to the CRISIL Report, the Indian PV (mass and premium segments) industry grew by a CAGR of 6.6% between Fiscal 2016 and Fiscal 2019, primarily due to increase in demand driven by improved economics, higher affordability and launches of new automobile modes. In addition, increase in average vehicle prices, resulting from annual price hikes and increased costs to comply with emission norms, had also provided a boost to the industry value.

Review of PV domestic (mass and premium market) sales value

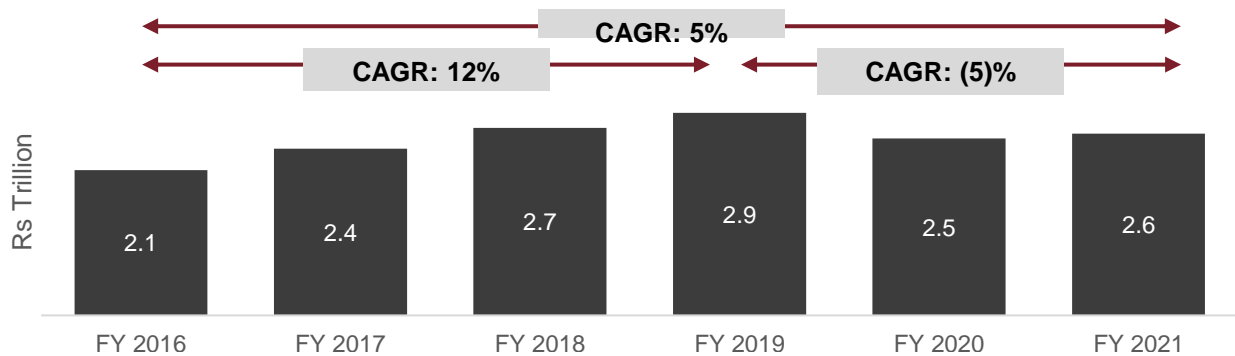

Source: SIAM- Society of Indian Automobile Manufacturers, CRISIL Research

In terms of types of vehicles, small cars have a major market share (in volume terms) in the PV (mass and premium markets) industry. However, small cars' market share in the PV (mass and premium) market decreased from 63% in Fiscal 2016 to 54% in Fiscal 2021, losing its market share to the UV segment. The UV segment, which traditionally appealed to customers who valued larger seating capacity and ability to drive on rough rural roads, witnessed a major shift in customer preference with the launch of compact UVs. The size of large car segment has gradually shrunk, as customers shift preference towards SUV segment due to high-end technology features and more frequent model launches.

PV domestic (mass and premium segments) sales split by vehicle types (in volume terms)

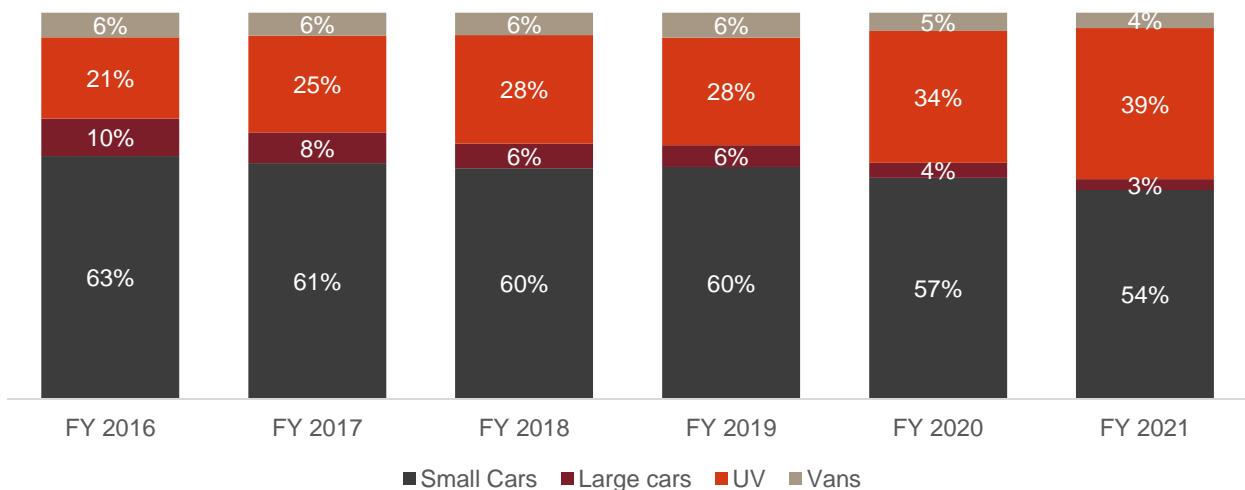

Source: SIAM, CRISIL Research

Segment	FY 2016-FY2019 CAGR	FY 2019-FY2021 CAGR	FY 2016-FY2021 CAGR
Small Cars	5 %	(15) %	(4) %

Segment	FY 2016-FY2019 CAGR	FY 2019-FY2021 CAGR	FY 2016-FY2021 CAGR
Large Cars	(11) %	(37) %	(22) %
UVs	17 %	6%	13%
Vans	7 %	(29) %	(9) %
Total market	7 %	(10) %	(1) %

Source: SIAM, CRISIL Research

### Competitive landscape of the key brands in the PV (mass and premium segments) industry

According to the CRISIL Report, the key original equipment manufacturers (OEMs) or brands in the Indian PV (mass and premium markets) include MSIL, Hyundai, Tata, M&M, Honda, Renault, VW and Fiat (Jeep). The following graph sets out the market share of each key brand in the Indian PV (mass and premium markets), in terms of value, for the years indicated:

PV domestic sales (mass+ premium market) share across OEMs (in volume terms)

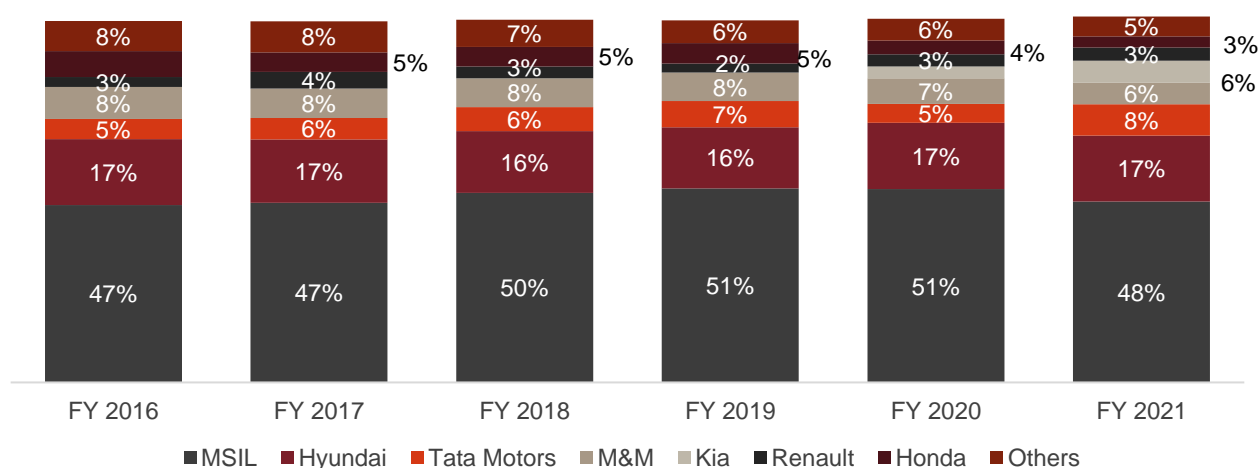

Source: SIAM, CRISIL Research

### State-wise split of the PV (mass and premium segments) industry in India

Maharashtra, Delhi, Uttar Pradesh, Gujarat, Kerala, Karnataka, and Tamil Nadu cumulatively make up over half of the total demand for PVs in the country. In fiscal 2021, these seven states contributed 52% to the overall domestic sales. The following table sets forth the state-wise split of PV (mass and premium segments) sales in India in Fiscal 2021, according to the CRISIL Report:

State	Fiscal 2021 sales ('000)	Share in national sales
Maharashtra	287	11%
Uttar Pradesh	254	9%
Gujarat	229	8%
Karnataka	185	7%
Kerala	169	6%
Haryana	164	6%
Tamil Nadu	152	6%
Rajasthan	137	5%
Delhi	132	5%
Telangana	131	5%
Madhya Pradesh	121	4%
Punjab	91	3%
West Bengal	89	3%
Andhra Pradesh	86	3%
Assam	70	3%
Others	414	15%

Source: SIAM, CRISIL Research

### Historical sales of the luxury PV segment

In Fiscal 2021, the luxury vehicles segment comprises approximately 1% of the overall PV industry in India, according to the CRISIL Report. The luxury vehicles segment consists of brands like Mercedes-Benz, Audi, BMW, Volvo and JLR. The ultra-luxury brands like Ferrari, Rolls Royce, Lamborghini form an insignificant part of this overall market.

According to the CRISIL Report, sales of the luxury segment increased at a CAGR of 9% between Fiscal 2016 to Fiscal 2019, driven by favourable economic growth, increased disposable incomes and more model launches by the OEMs/brands.

#### Luxury segment retail sales volumes

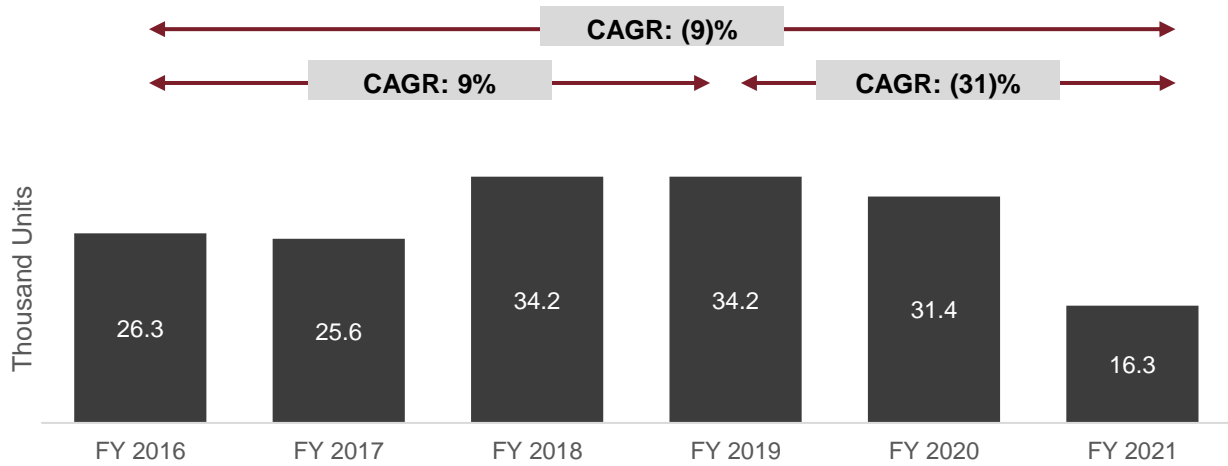

Source: Industry, CRISIL Research

### Competitive landscape of the key brands in the luxury PV segment

Given its vintage in India, Mercedes-Benz dominates the luxury cars market in recent years. In Fiscal 2021, Mercedes-Benz has a 44% market share in the Indian luxury vehicles segment, followed by BMW with a 36% market share, in value terms, according to the CRISIL Report.

#### Luxury car market share (in volume terms)

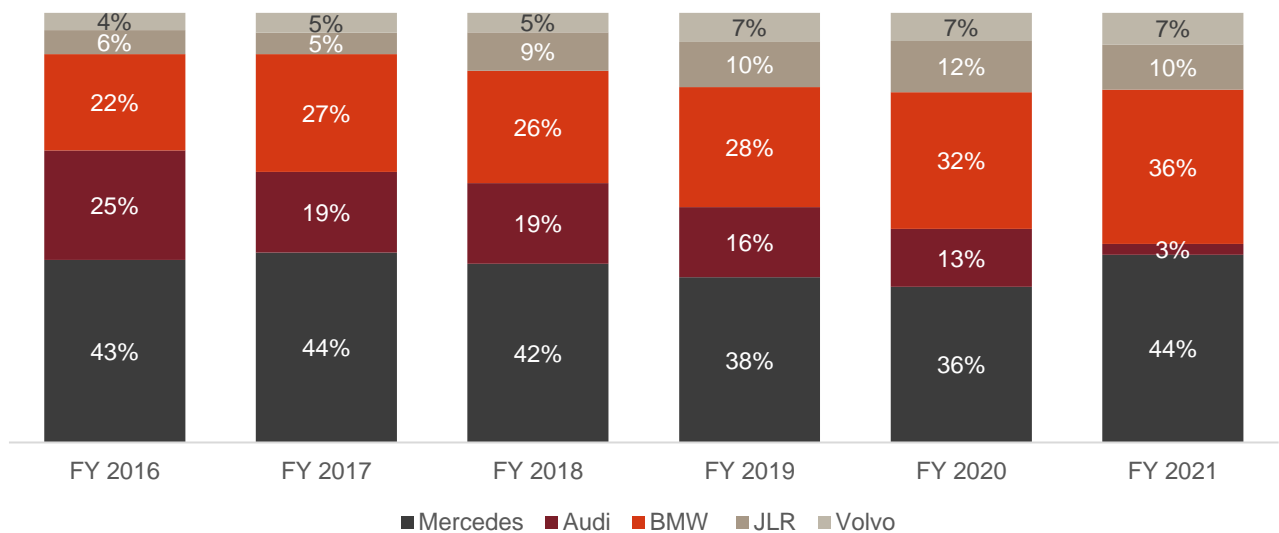

Source: VAHAN, CRISIL Research



## Outlook of the Indian passenger vehicle industry

### Sales outlook of the mass and premium PV segments

According to the CRISIL Report, the overall PV sales (mass and premium markets) in India, in terms of sales volume, is expected to grow at a CAGR of 8 to 10% from approximately 2.7 million units in Fiscal 2021 to approximately 4.2 million units in Fiscal 2026. CRISIL Research expects that the premium market segment to grow at a faster pace at a CAGR of 10-12% from Fiscal 2021 to Fiscal 2026, as compared to a CAGR of 6.7% for the mass market segment for the same period. The growth is expected to be driven by moderate macroeconomic growth, increasing urbanization, increasing disposable income, relatively stable costs of PVs, and improved availability of auto finance. However, in the short-run, subsequent waves of the COVID-19 pandemic resulting in any localised or extended lockdowns may have an adverse impact on the supply chains and overall industry sales.

#### PV domestic (mass and premium markets) sales outlook

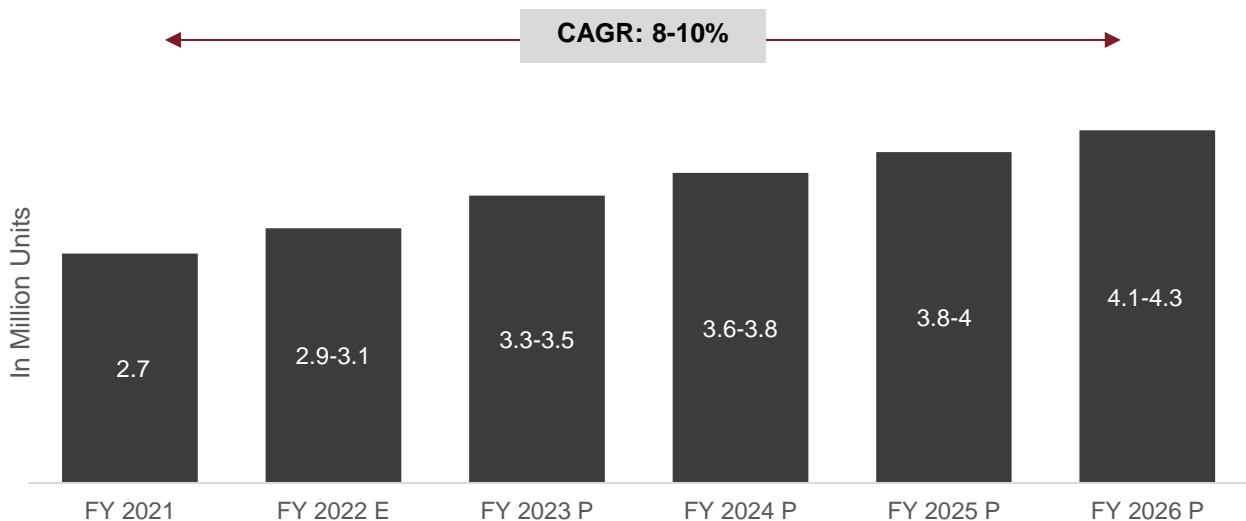

Note: E: Estimated. P – Projected Source: SIAM, CRISIL Research

CRISIL Research projects UVs to drive the growth of passenger vehicle industry in the long term. According to the CRISIL Report, UV segment (in volume terms) is expected to grow at a CAGR of 9-11% from Fiscal 2021 and Fiscal 2026 on a relatively low base. Small cars segment (in volume terms) is expected to grow at a CAGR of 8-10% and large cars segment is expected to grow at a subdued CAGR rate of 3-5% between Fiscal 2021 and Fiscal 2026.

#### PV sales (mass and premium markets) outlook by vehicle types (in volume terms)

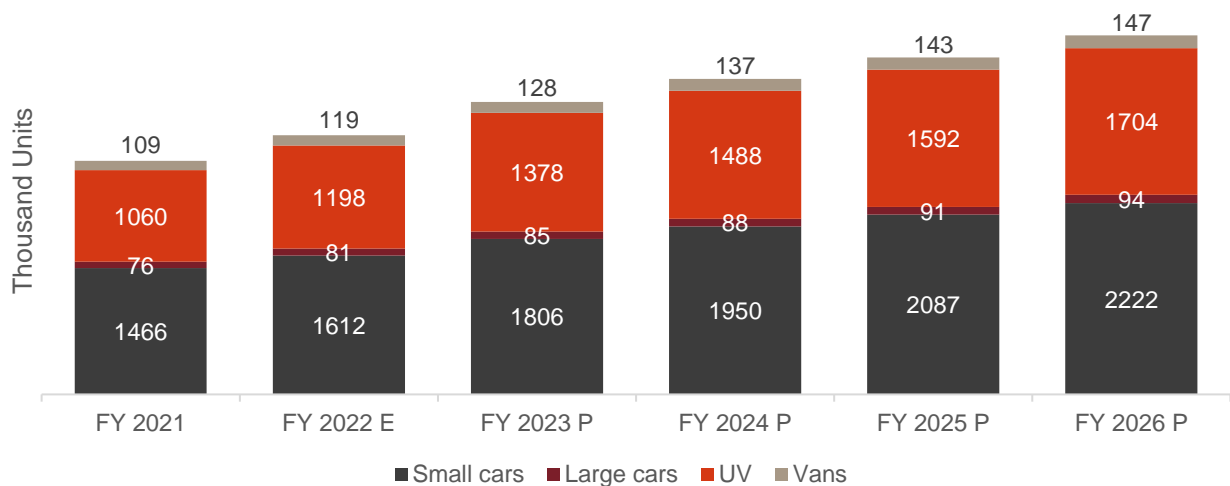

Note: E: Estimated, P – Projected.  
Source: SIAM, CRISIL Research

### Sales outlook of the luxury PV segment

According to the CRISIL Report, the luxury vehicles segment in India is expected to grow at a CAGR of 20-22% from 163,00 units in Fiscal 2021 to 420,00 to 440,00 units by Fiscal 2026. On a low base of fiscal 2021, this growth is expected to be driven by estimated improvement in economic environment, increase in disposable incomes as well as intermittent launches by OEM/brands.

#### PV domestic luxury market sales outlook (volume)

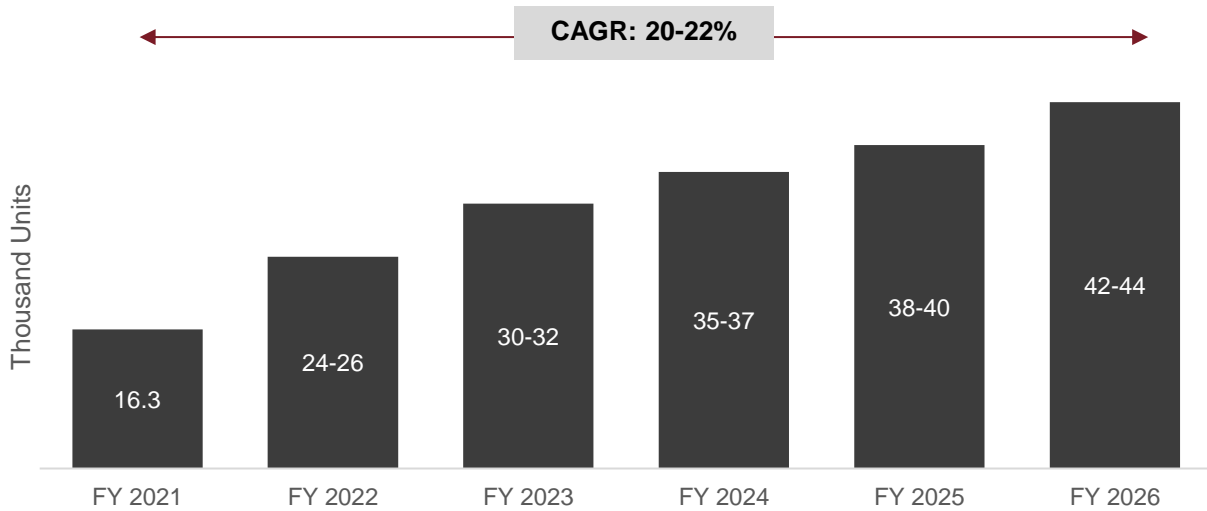

Source: SIAM, CRISIL Research

### Key trends and growth drivers of the Indian PV industry

#### Improved auto finance availability

Given the industry's higher ticket sizes and better credit profile of end customers, finance penetration is higher in the PV industry compared with other automobile segments. According to the CRISIL report, finance penetration levels for the PV industry has increased from 74% in Fiscal 2016 to 79% in Fiscal 2021.

#### PV finance penetration – Fiscals 2016 to 2021

(%)

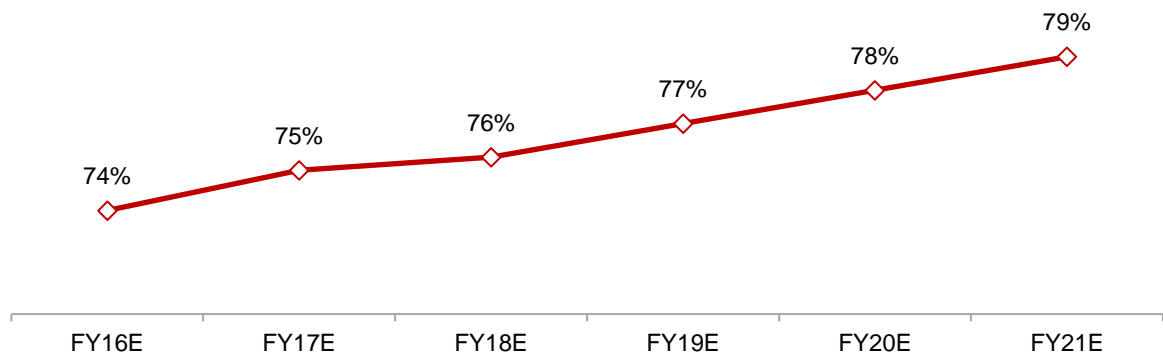

Note: E – Estimated; Note: Finance penetration indicates number of vehicles financed per 100 two wheelers sold in India  
Source: CRISIL Research

#### Increasing demand for personal mobility

Increased need for social distancing as a result of the Covid pandemic accentuated the demand for personal mobility. According to the CRISIL Report, the increasing demand for personal mobility is expected to provide a significant push to the demand of PV industry in Fiscal 2021 and Fiscal 2022. Despite the reduction of new Covid cases, the demand for

personal mobility has not subsided and is expected to continue in the medium term providing an additional fillip to the passenger vehicle demand. The increasing disposable income will support the growth in personal mobility demand.

#### *Customer preferences shift towards premium products*

Consumers are increasingly preferring premium, aesthetically superior and technology savvy vehicles, primarily driven by rising disposable income and exposure to preferences in developed markets. Consumers are increasingly willing to pay for aesthetically superior and differentiated products. Consumer preference is shifting towards bigger cars. The demand for mid- and top- variants of passenger vehicle models has seen a gradual increase over the recent years. CRISIL Research expects the contribution of mid and top variant to increase 5-10% (in volume terms) in the small car segment, and by 15% in the large car and UV (Utility vehicles) segment by Fiscal 2026. As a result, the average selling price of the passenger vehicles is expected increase going forward.

Segment	FY21 (mid + top variant)	FY26 (mid + top variant)
Small	30-40%	40-50%
Large	70-75%	85-90%
UV	50-55%	65-70%

Note: UV: Utility vehicles

Source: CRISIL Research

#### *Electric passenger vehicles*

The Government announced Rs. 100 billion incentives for Phase 2 of Faster Adoption and Manufacturing of Hybrid and Electric Vehicles commencing from April 1, 2019. However, such incentive is only for commercial use vehicles and no benefits is provided to personal car owners. Penetration of electric passenger vehicles is low at approximately 0.16% in Fiscal 2021. CRISIL Research expects that the share of electric vehicles in total passenger car sales to remain low at approximately 4% in Fiscal 2026. Future growth in electric vehicles will depend on the incentives given by the Government as well as establishment of battery charging infrastructure. Increase in electric vehicles adoption will increase the average selling prices of passenger vehicles, as the selling prices of electric vehicles are generally 80-90% higher than their internal combustion engine counterparts.

According to the CRISIL Report, the models of electric vehicles available in the India market are:

Company	Model	Ex Showroom price (Rs. Millions)	Features
Mahindra	E verito	0.95 to 1.00	21.2 kWh battery with range of 180 km
Mahindra	eKUV 100	0.80 to 0.85	15.9 kWh battery with range of 147 km
Tata	Tigor EV	1.15 to 1.20	16.2 kWh battery with range of 140 km
Tata	Nexon EV	1.35 to 1.45	30.2 kWh battery with range of 312 km
Hyundai	Kona	2.35 to 2.40	39.2 kWh battery with range of 452 km
MG	ZS EV	2.05 to 2.10	44.5 kWh battery with range of 340 km
BYD	E6	2.90 to 3.00	71.7 kWh battery with range of 415 km

Source: CRISIL Research

Few of the leading players operating in the global EV market include Tesla, BYD, BAIC, SAIC, Renault-Nissan-Mitsubishi, Volkswagen AG and BMW.

#### *Enhanced product offering*

Sales of new models have supported overall industry growth in the past few years. Majority of the new models launched were in the UV segment, supporting the growth of such segment in the past few years. Going forward, CRISIL Research expects that upcoming models such as Nissan Magnite, Renault HBC and Tata HBX are also expected to gain traction. The following tables set out the recent and upcoming major model launches by brands and market segments:

#### *Recent & upcoming major vehicle launches - mass market*

Segment	Player	Model
Mass market	MSIL	Celerio Facelift
Mass market		Jimny
Mass market		Swift Hybrid
Mass market		Alto facelift
Mass market	Tata Motors	Punch

<b>Segment</b>	<b>Player</b>	<b>Model</b>
Mass market		Tiago EV*
Mass market		Sierra
Mass market		Altroz EV*
Mass market	Mahindra	XUV 300 facelift
Mass market		Scorpio facelift
Mass market	Honda	Brio facelift
Mass market	Renault	Zoe
Mass market	VW	Taigun
Mass market		Polo facelift
Mass market	MG	Astor
Mass market	Hyundai	Ioniq*
Mass market		Tucson facelift
Mass market	Kia	Ceed

*Recent & upcoming major vehicle launches - premium market*

<b>Segment</b>	<b>Player</b>	<b>Model</b>
Premium market	Mahindra	XUV 700
Premium market		eKUV100*
Premium market	Honda	HR-V
Premium market	Renault	K-ZE EV*
Premium market	VW	Passat Facelift
Premium market		Vento facelift
Premium market	MG	RC 6
Premium market		MG 3
Premium market	Hyundai	Elantra facelift
Premium market		Santa Fe facelift
Premium market	Kia	Seltos 7 seater
Premium market		Sportage
Premium market	Jeep	Carnival facelift
Premium market		7- seater SUV
Premium market		Grand Cherokee

*Recent & upcoming major vehicle launches - luxury market*

<b>Segment</b>	<b>Player</b>	<b>Model</b>
Luxury market	Mercedes-Benz	EQA EV*
Luxury market		C class facelift
Luxury market		EQS EV*
Luxury market		GLB
Luxury market	Audi	Q7 facelift
Luxury market		Q5 facelift
Luxury market		Q3 facelift
Luxury market		A3 facelift
Luxury market	BMW	M3
Luxury market		M4
Luxury market		X6
Luxury market	Volvo	S90 facelift
Luxury market		XC 40 Recharge*
Luxury market	JLR	V60
Luxury market		E pace
Luxury market		CX17
Luxury market		DC100

Note: \* : Electric Vehicles

Source: Industry, CRISIL Research; CRISIL Report

## Review of the pre-owned PV industry in India

### *Business models of pre-owned vehicle market participants*

Exchanged vehicles from the new car dealerships are routed to pre-owned vehicle dealerships of organized original equipment manufacturer backed players like True Value, Mahindra First Choice etc. Unorganised/local/relatively smaller dealers procure vehicles from sellers, agents, digital platforms as well as exchanged vehicles from new car dealers.

Organised as well as unorganized dealers refurbish the vehicle and put it in the showroom with a markup. Customers get finance, insurance, warranty at the showroom. Main revenue streams for the organized players are - revenue from selling cars and the commission earned from third parties for finance and insurance. Sales of pre-owned vehicles also provides an additional boost to new car sales of large organized players by providing a trade in value for the old car of the customer.

According to the CRISIL Report, as of Fiscal 2021, finance penetration in the pre-owned industry is 25-30%. Dealers earn 1-3% of the financed amount as a commission from financiers. On the other hand, insurance penetration is relatively lower at 15-20% as of Fiscal 2021. Generally, dealers earn up to 19% of insurance premium as a commission on insurance.

Organised players especially original equipment manufacturer-backed dealerships have also invested in the digital platforms to supplement their brick-and-mortar business. Potential customers can view available vehicle inventory with the dealership chain and access the dealer details from the website to go to the physical store to test drive and finalise the vehicle. Value added services like financing and insurance is also available online for these OE chains.

Pre-owned PV market used to be an unorganized space where there were a lot of small brokers and sellers operating across geographies. Buyers predominantly bought used vehicles from their friends/ relatives or nearby garages. Sales through unorganized local dealers forms the major share of the overall market. According to the CRISIL Report, as of Fiscal 2016, unorganized segment contributed to approximately 62-65% of the pre-owned PV market, with organised segment contributed only 15-17%. As of Fiscal 2021, nearly half of the overall sales in the pre-owned PV market were executed by unorganised dealers. However, 30% of the lead generation for unorganised dealers happens through digital platforms. Organised dealers contribute 20-22% while ~25% of the sale happen directly from customer to customer.

### *Pre-owned PV market segmentation as of Fiscal 2021*

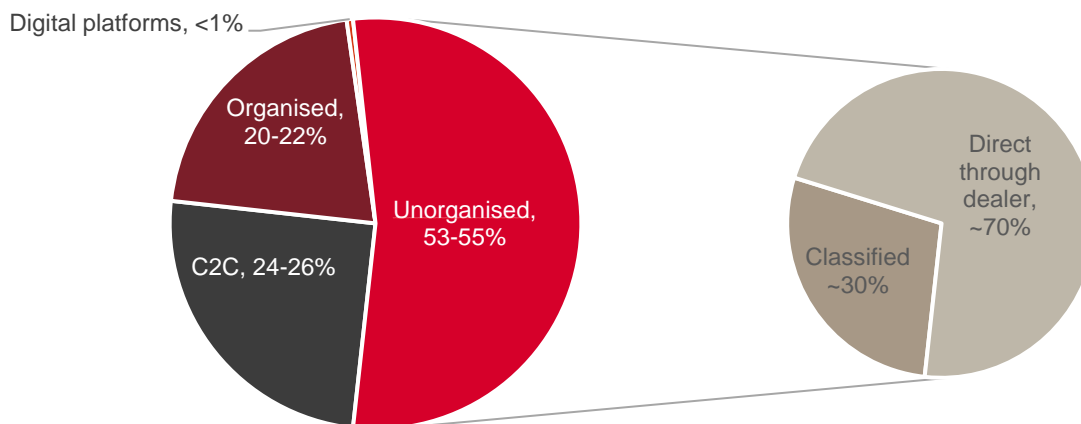

*Note: **Organised dealers** are the dealers with sales showroom and workshop; It also includes OE backed dealerships such as True Value, Mahindra First Choice etc*

***Unorganised dealers** are the dealers with or without basic sales set up and without workshop*

***Classified** are the digital platforms through which dealers list vehicle for selling to customers*

***Digital platforms** are the physical Stores of digital platforms like OlxAuto, Spinny, Cars24*

***C2C** denotes direct customer to customer transactions*

*Source: Industry, CRISIL Research*

Going forward, CRISIL Research expects that ahead, we expect the industry to move towards organised segment (including digital platforms) backed by higher convenience, transparency, choices, value added benefits provided by the organized segment. By Fiscal 2026, CRISIL Research expects organized segment (including the physical stores of digital platforms) to cater to ~30% of the demand and support nearly 50% of the demand of unorganized segment through classifieds (i.e. digital platforms through which dealers list vehicles for sale to consumers).

**Historical sales of the pre-owned PV (mass and premium markets) industry**

According to the CRISIL Report, in the past few years, the market for pre-owned PVs has grown significantly in India. In the past few years, changing buyer demographics and intermittent launch of feature-rich vehicles have been shortening the replacement cycles, aiding supply in the market. Moreover, the availability of easy financing at competitive rates, the emergence of digital platforms as well as the price rise in new PVs further drive the demand in the pre-owned PV industry. The industry was adversely impacted by the COVID-19 pandemic in Fiscal 2021, as the supply chain of new PVs (and hence the pre-owned PVs) were negatively affected by the pandemic. However, pre-owned PV sales continued to outpace new-PV sales even in Fiscal 2021, with the ratio of pre-owned PV to new PV sales hovering around 1.3-1.7 during the year. For Fiscal 2022, CRISIL Research expects that the pre-owned PV industry will slowly normalize, with the reopening of economy, increased inoculations and in turn improved mobility. Assuming no resurgence of the pandemic, CRISIL Research expects that the demand for pre-owned PVs (mass and premium markets) to grow by 13-15% in Fiscal 2022, from a low base in Fiscal 2021.

*Sales of pre-owned mass + premium vehicles*

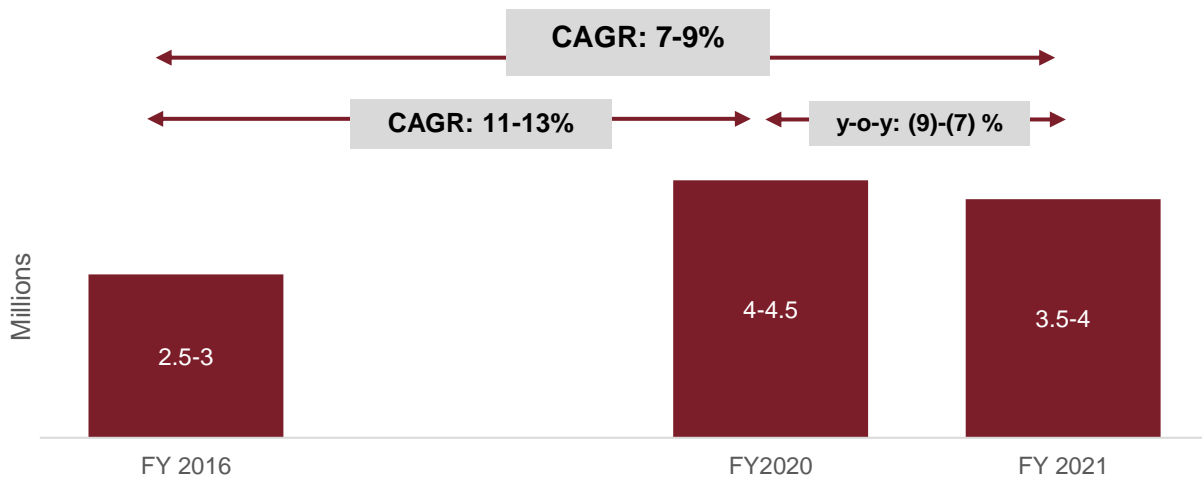

Source: Industry, SIAM, CRISIL Research

**Historical sales of the pre-owned luxury PV industry in India**

According to the CRISIL Report, the pre-owned luxury vehicle market has increased substantially from approximately 5,000 units annual vehicle sales in Fiscal 2008 to 40,000 annual sales in Fiscal 2019, amounting to a CAGR of 23% during the same period. Improvement in the economic scenario, increase in disposable incomes, entry of new global OEMs, portfolio expansion and new model launches by players provided the traction for this growth.

*Sales of pre-owned luxury vehicles*

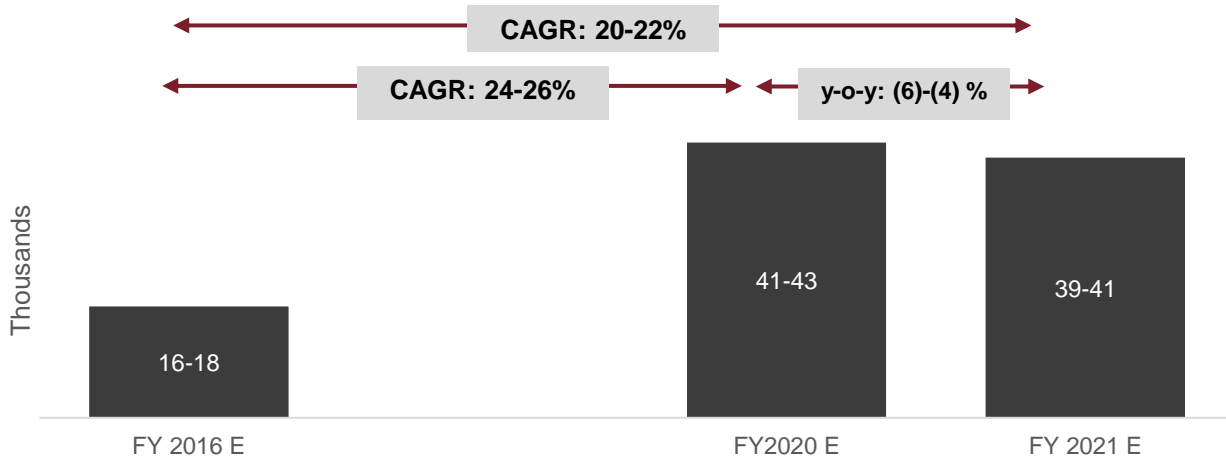

Source: Industry, VAHAN, CRISIL Research

### Outlook of the pre-owned PV industry

In the long run, CRISIL Research expects a healthy revival in the pre-owned PV (mass and premium markets) industry, primarily driven by increasing need for personal mobility, rising aspirations of customers, growing disposable income, lowering replacement cycles and increasing financial penetration. In addition, the expanding share of the organised segment will provide an added boost to demand. According to the CRISIL Report, the pre-owned PV (mass and premium markets) industry is expected to grow at a CAGR of 12-14% between Fiscal 2021 and Fiscal 2026 to reach 6.8-7.3 million vehicles in Fiscal 2026.

Luxury pre-owned cars is another sector growing steadily since the last few years. Emergence of mega retail centres and luxury OEMs setting up their pre-owned car retail businesses indicates growing interest of sellers to cash-in on this. Heavy discounts offered during Covid brought more customers to this segment.

Moreover, the expected increase in finance penetration from 25-30% in fiscal 2021 to 35-40% by fiscal 2026 shall provide an additional kicker to the demand, according to the CRISIL Report.

According to the CRISIL Report, the ratio of pre-owned PV sales to new PV sales is expected to reach 1.6 to 1.8 times by Fiscal 2026.

### Outlook for pre-owned PV (mass and premium market) industry

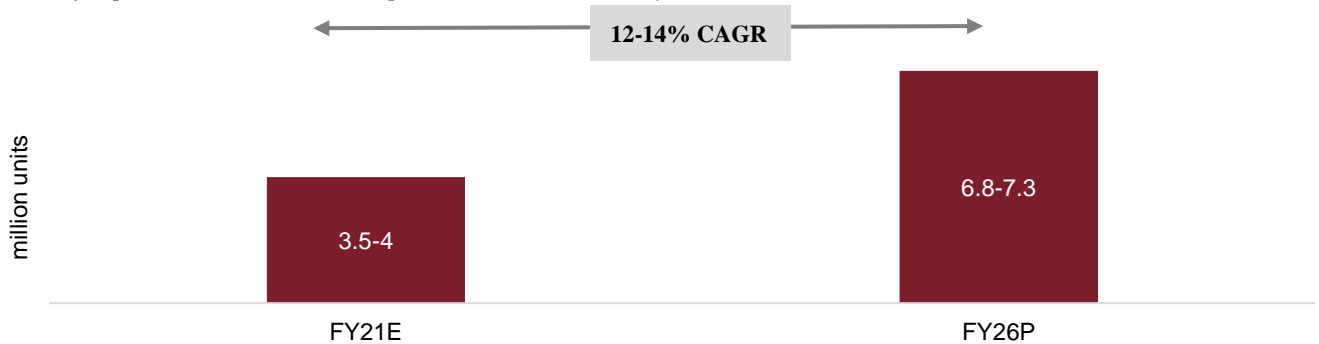

Note: E – Estimated, P - Projected  
Source: Industry, CRISIL Research

### Key drivers for the growth of the pre-owned PV (mass and premium markets) industry

#### Lower vehicle penetration

India lags far behind its peers in vehicle penetration per 1,000 people. According to the CRISIL Report, as of calendar year 2015, vehicle penetration in India's PV (mass and premium) market in India was approximately 23-25 vehicles per 1,000 people. Compared with other countries, India has a substantial growth potential.

#### Country-wise passenger vehicle penetration

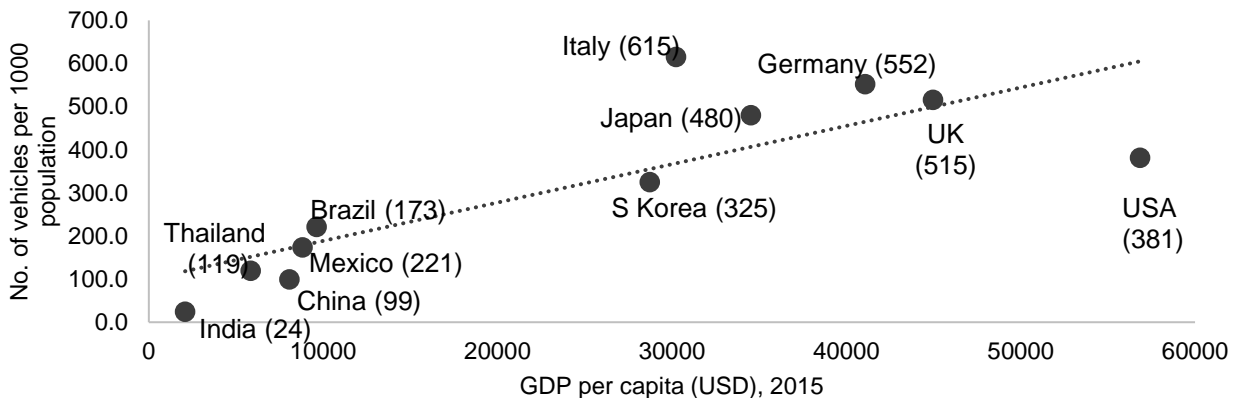

Note: Figures, except India, are as of calendar year 2015 (OICA data available until 2015); the dotted line indicates median; figures in the bracket indicate passenger vehicles per 1,000 people  
Source: Organisation Internationale des Constructeurs d'Automobiles (OICA), World Bank, CRISIL Research

### *Nascent stage of pre-owned PV industry in India*

The pre-owned PV industry in India is still in its nascent stage. According to the CRISIL Report, the ratio of pre-owned PV to new PV sales in India currently stood at 1.3-1.5, while the ratio stood at 1.9 for the United States and Germany, 2.7 for France and 3.5 for the United Kingdom. The ratios reflect that the pre-owned PV market is much more advanced for developed economies. CRISIL Research expects that India has a lot of growth potential in the pre-owned PV market, particularly as the segment gets more organised over time. CRISIL Research expects that the ratio of pre-owned PV to new PV sales in India to reach 1.6-1.8 by Fiscal 2026.

### *Advent of digital platforms*

Internet penetration in India has grown at a rapid pace in the past few years. According to the CRISIL Report nearly 30% of telecom subscribers in India had access to internet in Fiscal 2015; it is estimated to have increased to 75% in Fiscal 2022. The number of internet users in India is expected to exceed 1 billion by Fiscal 2026, aided by approximately 10% CAGR growth in smart phone users.

The recent emergence of digital platforms has provided an additional thrust to the pre-owned car industry growth. Digital platforms provide more choices, convenience, reliability and transparency into this market. All these factors were majorly lacking in the pre-owned car market which was completely dominated by unorganized players.

Digital platforms not only aid the market from supply side by supporting dealer procurement, but it also provides a platform for dealers to showcase and sell their refurbished vehicles supporting demand growth. The added transparency in the vehicle valuation and price discovery are other important aspects backing the industry growth.

### *Younger demographic and shortening PV replacement cycle*

According to Indian Census 2011 projections, India continues to have a very young demographic with an estimated 61% of its population below 35 years and a median age of around 28 years by 2021. This younger demographic does not see any stigma with buying a pre-owned PV unlike the older ones and they have contributed to the acceptance of pre-owned PV segment, especially in small towns and cities.

In the past few years, the vehicle replacement cycle has been coming down from 6-8 years a few years ago to about 4-6 years in fiscal 2021. The sharp rise in launches of advanced, feature-rich, trendy-looking vehicles at competitive prices has been pushing the young customer demographic to sell off their old vehicles for one of the latest ones. The shortening replacement cycle of the new vehicle buyers as well as the young demographic in India supports the growth of the pre-owned PV industry in India.

## **Review of the Indian commercial vehicle industry**

### *Historical sales of Indian commercial vehicle industry*

According to the CRISIL Report, in value terms, the sales of commercial vehicle (CV) in India grew at a CAGR of 17% from Rs. 777.2 billion in Fiscal 2016 to Rs. 1,249.4 billion in Fiscal 2019.

### *CV domestic industry value trend*

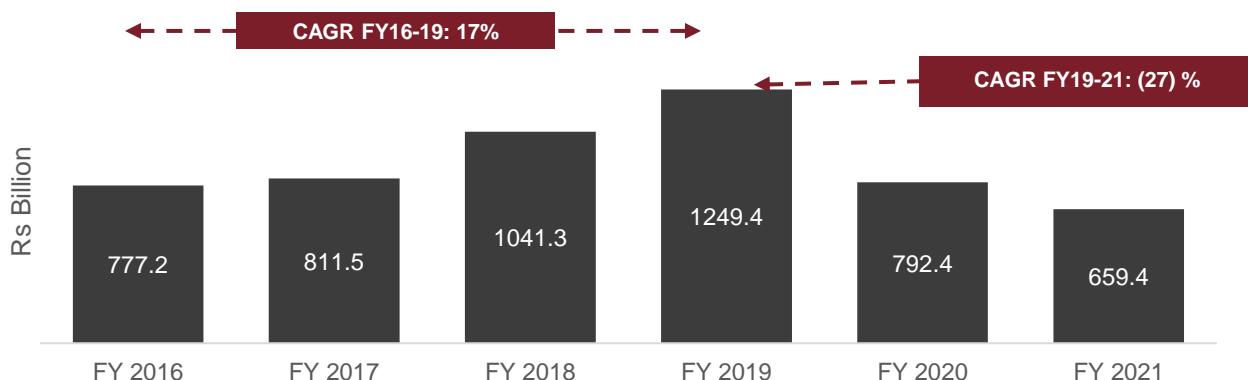

Source: SIAM and CRISIL Research



Historic domestic sales (fiscal 2016 to 2021)

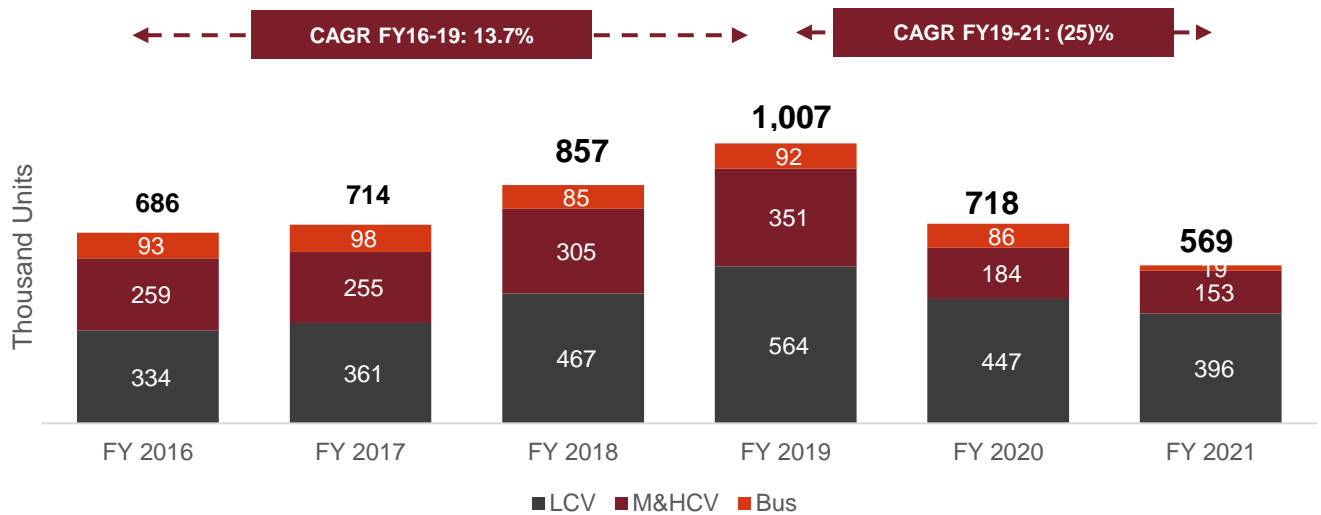

Note: E – Estimated; Domestic sales are exclusive of Bharat Benz sales as the same are not reported by SIAM  
 Source: SIAM and CRISIL Research

Indian CV industry by types of vehicle

The CV industry can be categorized into the following segments by types of vehicles: light commercial vehicle (LCV), medium and heavy commercial vehicle (M&HCV) and small commercial vehicle (SCV).

Segment wise sales split FY21

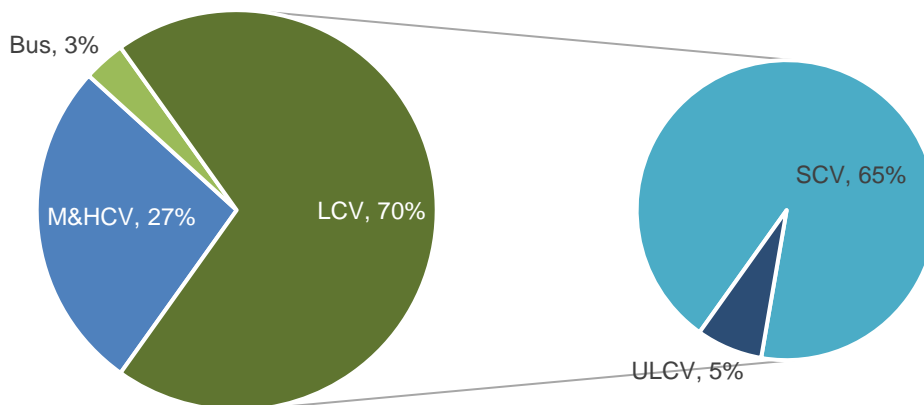

Source: CRISIL Report

According to the CRISIL Report, M&HCV sales registered a negative 12% CAGR between Fiscal 2016 and Fiscal 2021, primarily due to low sales in Fiscals 2020 and 2021 as a result of the pandemic. On a low base in Fiscal 2021, CRISIL Research expects that M&HCV sales to grow at a CAGR of 15-17% CAGR between Fiscal 2021 and Fiscal 2026. The grow is expected to be driven by improved product mix, improving industrial activity, steady agricultural output, and the government’s focus on infrastructure. However, further volume growth will be limited by efficiencies achieved post introduction of the GST regime and better road infrastructure, along with commissioning of the dedicated freight corridors.

According to the CRISIL Report, LCV demand is expected to record a 9-11% CAGR between Fiscal 2021 and Fiscal 2026, primarily driven by higher private consumption, low penetration levels providing headroom for growth, greater availability of redistribution freight, and improved finance availability post Fiscal 2021.

CRISIL Research projects domestic bus sales to record a CAGR of 34-36% CAGR between Fiscal 2021 and Fiscal 2026 on a very low base of Fiscal 2021. The growth is expected to be driven by increasing demand for inter-city/-state travel, aided by better road infrastructure, and higher personal disposable incomes. This unregulated segment primarily caters to demand from schools, companies and inter-city travel by private operators. A large part of the demand will originate from replacement of Jawaharlal Nehru National Urban Renewal Mission buses, which were sold during fiscals 2011 and 2012, once funds are released by the Centre and state governments to purchase the buses. This replacement is expected to gain pace post fiscal 2021, aiding long-term MCV bus growth. However, further expansion in bus sales would be affected by the commissioning of metro rails and monorails in several cities.

**Competitive landscape of the CV industry in India**

According to the CRISIL Report, the Indian commercial vehicle industry is led by Tata Motors, followed by Ashok Leyland and Mahindra & Mahindra Ltd.

Overall CV industry split by market share across OEMs

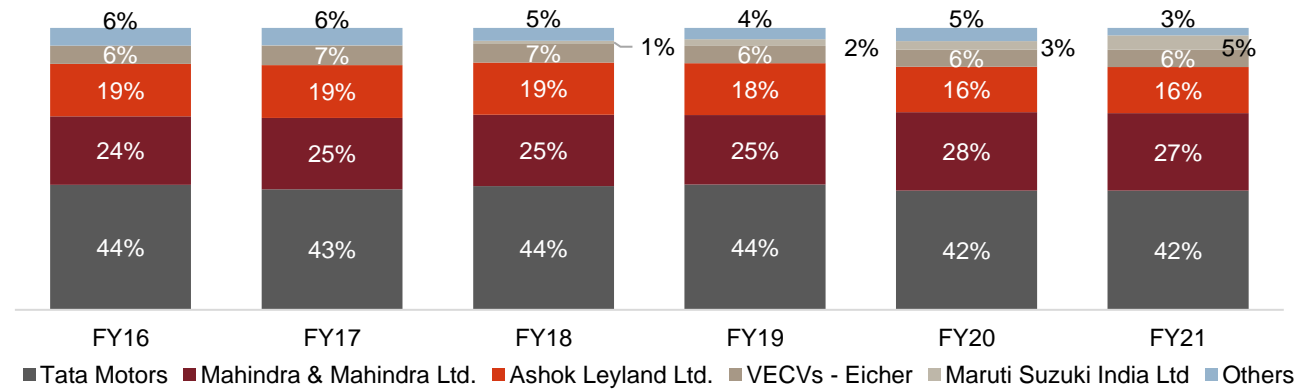

Source: SIAM and CRISIL Research

**Outlook of the Indian commercial vehicle industry**

**Domestic sales outlook of the Indian CV industry**

According to the CRISIL Report, domestic CV sales are expected to register a 12-14% CAGR between Fiscal 2021 and Fiscal 2026. From a low base in Fiscal 2021, domestic sales in 2022 is expected to be driven a gradual revival of industrial activities, increased people mobility, accelerating pace of vaccination, rising domestic consumption, improving rural incomes, government’s focus on infrastructure investments through the National Infrastructure Pipeline (NIP), initiation of commercial mining in India and roll out of the scrappage policy.

CV domestic sales outlook (In thousand units)

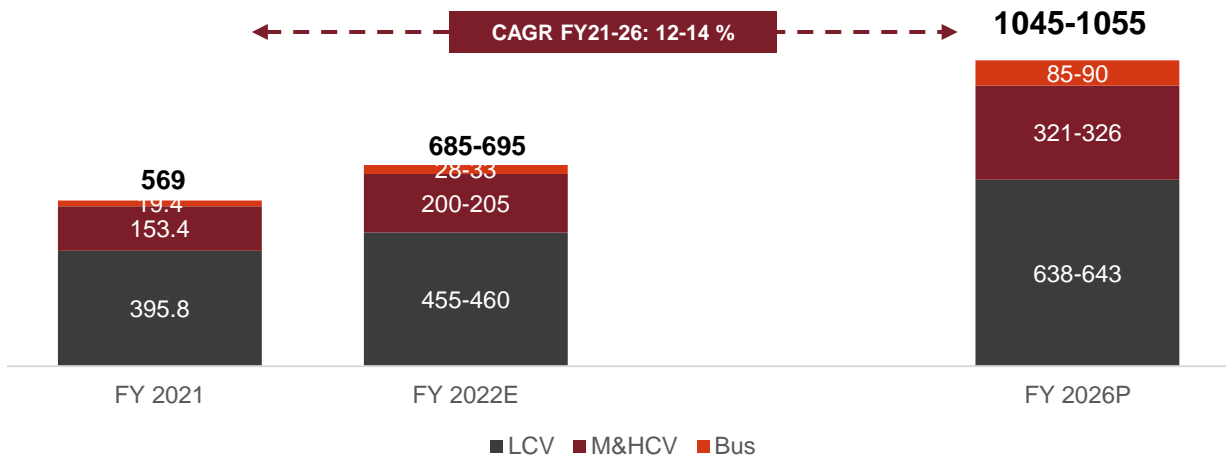

Note: E - Estimated; P – Projected, Domestic sales exclude Bharat Benz’s sales as its sales figures are not reported by SIAM  
Source: SIAM, CRISIL Research

## Key trends and growth drivers of the Indian CV industry

### NIP plan

According to the CRISIL Report, the National Infrastructure Pipeline (NIP) plan aims to double infrastructure investment per year from the current average of Rs. 10 trillion per year to Rs. 22 trillion per year. Of the total NIP investment of Rs. 111 trillion, Rs. 44 trillion (40%) worth of projects are under implementation, Rs 34 trillion (30%) worth of projects are at the conceptualisation stage, and Rs. 22 trillion (20%) worth of projects are under development. Almost 83% of project allocation indirectly benefits the CV sector in India, and this push for infrastructure is a major driver of growth for the industry.

Currently, further new projects have been added to the NIP programme and the current total cost of projects under NIP stands at about Rs 144 trillion as per the India Investment Grid as of October 2021. Furthermore, the contribution Gujarat and Madhya Pradesh in NIP is fairly significant, with these two states together accounting for 8-10% of the overall planned outlay of the programme.

Gujarat capital expenditure for fiscal 22 is proposed to be Rs 565.7 billion, which is an annual increase of 50% over revised estimates of fiscal 21 and 14% over the actual expenditure in fiscal 20. Of the infra projects, urban development will see 11% higher expenditure over last year. On the other hand, some drop is expected in outlay for Roads and irrigation.

### State infrastructure outlay in Gujarat (Rs. Billion)

Account	FY20	FY21RE	FY22 BE
Road & Bridges	88.6	99.8	96.0
Urban development	119.0	107.7	119.4
Irrigation and flood control	98.0	109.2	101.4
Other	131	59.8	248.9
<b>Total capex</b>	<b>436.6</b>	<b>376.5</b>	<b>565.7</b>

Note: BE – Budget estimates; RE – Revised estimates;

Source: Finance department, Government of Gujarat

Madhya Pradesh capital expenditure is proposed to be Rs 619.5 billion which is annual increase of 44% over revised estimates of fiscal 21 and 50% over fiscal 20. Road & bridges expenditure is proposed to be 12% over revised estimates of last year.

### State infrastructure outlay in Madhya Pradesh (Rs. Billion)

Account	FY20	FY21RE	FY22BE
Roads & Bridges	73.0	61.9	69.6
Irrigation and flood control	101.2	102.6	98.6
Other	237.4	266.3	520.9
<b>Total capex</b>	<b>411.6</b>	<b>430.8</b>	<b>619.5</b>

Note: BE – Budget estimates; RE – Revised Estimates;

Source: Finance department, Government of Madhya Pradesh

### Scrappage policy

In August 2018, the Ministry of Road Transport and Highways considered incentivising the scrapping of vehicles sold before April 2005 (15 years old). To incentive business to replace old vehicles with new ones, the Government aims to exempt registration charges for truck purchases made after scrapping older trucks, increase renewal fees for registration of older vehicles, as well as increase the frequency for the need to obtain fitness certificates for older vehicles.

### Electrification of LCVs

Currently, most of the EVs used in the commercial segment as goods carriers are three-wheelers. However, as the cost differential between electric and diesel vehicles start reducing, we expect new models to be launched. This will drive sales in the segment as the local distribution of goods are well suited applications for EVs. CRISIL Research expects that EV sales in the LCV goods segment to rise to 36,000-39,000 vehicles by Fiscal 2026. This would represent approximately 5% of the total LCV goods vehicle market in Fiscal 2026.

## EV LCV goods vehicles' domestic sales outlook

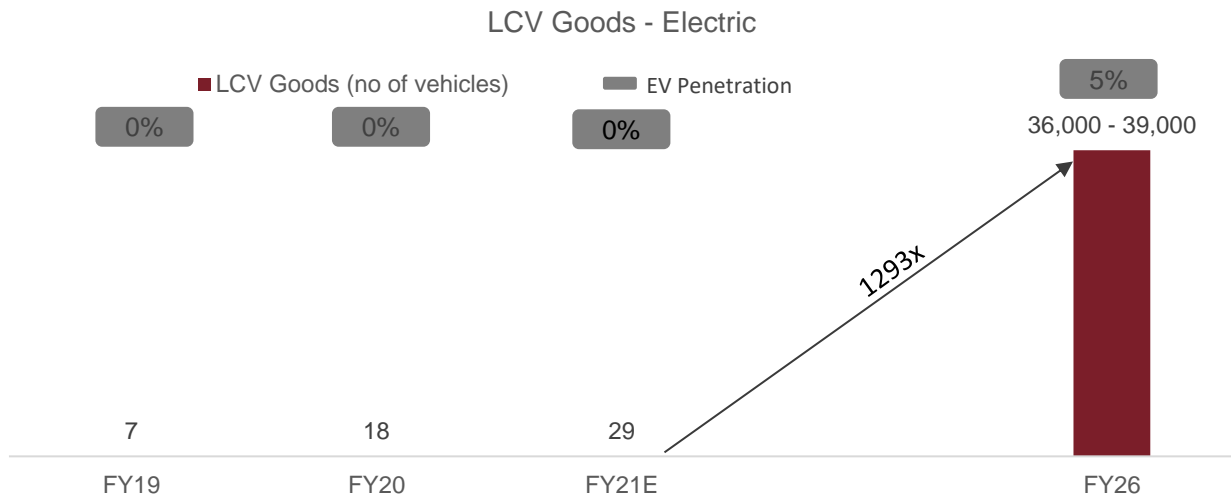

Note: N.M = Not meaningful  
Source: CRISIL Research

## Automobile dealership industry in India

### Role of an automobile dealer

Dealerships form an intrinsic part of the automobile sector playing the role of an intermediary between the customers and the manufacturers. The dealership plays an indispensable role in the overall vehicle supply chain providing local vehicle distribution channels based on a contract with an automaker. It also plays a key role in the aftermarket space by providing maintenance services and supplying spares/automotive parts as well as accessories.

From manufacturers' perspective, dealers play the crucial role of retail distribution at regional, city and local levels and also provide manufacturers with customer insights that are very useful in the production planning of manufacturers.

Dealers support customers from the initial phase with guidance for vehicle selection and also assist in the necessary vehicle financing. They facilitate a smooth transfer of vehicle from manufacturer to customer, assisting in registration and required insurance formalities. Additionally, the dealers also provide required support for accessorising and vehicle customisation.

For financial institutions, dealerships provide a huge business opportunity in the form of retail finance as well as inventory funding. For insurance providers, dealerships act as an easy avenue of new customer acquisitions.

### Dealership scenario in India

As of Fiscal 2021, there are more than 17,000 dealerships with nearly 27,000 touchpoints across India catering to customers of two-wheelers, passenger vehicles, CVs, three-wheelers and tractors. Two-wheelers dominate the number of dealerships with nearly 60% share, followed by the passenger vehicles segment with approximately 15% share and CVs forming another 10%. The remaining is formed by three-wheelers and tractor dealers. Presence of three-wheelers and tractor distributorships is relatively limited.

Dealers normally have three types of outlets: sales-service-spares (3S), only sales (1S), and only workshops. Most large dealers have multiple outlets or touch points with a few 3S outlets and many workshops/ service stations across the city. They also have a large sub-dealer network that works under the umbrella dealership and caters to smaller semi-urban/rural areas nearby. A few dealers also have ARDs (authorised representative of the dealer) that provide the minimal required services to customers in rural areas. ARDs are more prominent in the two-wheeler segment.

Dealers are not able to expand exponentially in a short span of time, given the very high initial investment required as well as agreement conditions with manufacturers. Consolidation as the primary source of business expansion for the dealers. Consolidation is achieved by acquiring smaller dealerships as well as obtaining the dealership code from a defunct dealership. OEMs also prefer to be attached to a larger dealer with successful experience of running a dealership, ensuring higher customer satisfaction and in turn market share expansion.

According to the CRISIL Report, currently, there are only a handful of very large dealerships in India with more than 100 outlets and a presence across four to five states in India. Compared with global dealership giants such as Penske Automotive (approximately 320 dealerships across the United States and United Kingdom), Group 1 automotive (approximately 185 dealerships across the United States, United Kingdom and Brazil) and Zhongsheng Group Holding (386 dealerships across China), Indian dealerships are still in the development stages with significant room for expansion.

According to the CRISIL Report, these global dealerships also have a significant revenue contribution (approximately 30% compared with 7-15% for their Indian counterparts) from their pre-owned vehicle business. In volume terms, for global dealerships, approximately 50-55% of vehicles sold are pre-owned, compared with only 20-25% for Indian dealers.

**Revenue streams for a PV dealership**

For a typical PV dealer, there are five major revenue streams.

Revenue streams for a dealership

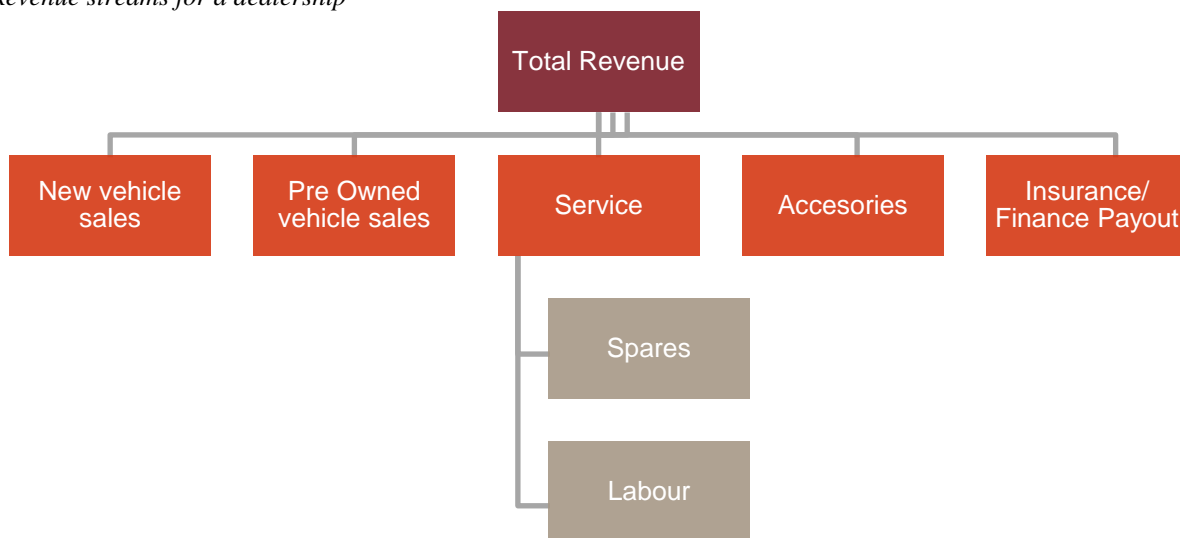

Source: CRISIL Report

**Passenger vehicles dealership landscape in India**

**Increase in PV dealerships in India**

PV dealerships form approximately 15% of overall dealerships in India and contribute to approximately 20% of the overall touchpoints. Primary PV dealerships are typically based out of large cities with multiple outlets throughout the city and a sub-dealer network covering nearby semi-urban and rural areas. All the multiple outlets and sub-dealers work under the umbrella dealership where the primary dealership handles overall ordering and procurement.

Trend in number of PV dealerships

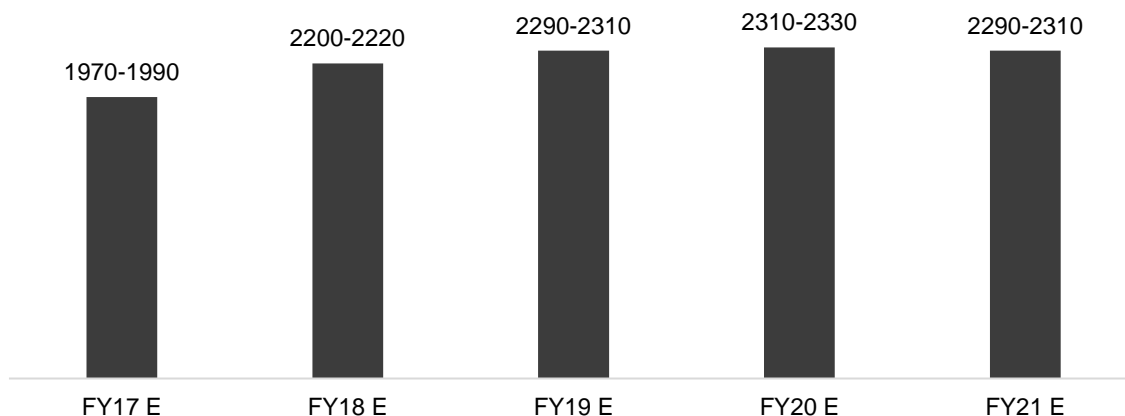

Source: Industry, CRISIL Research

**Breakdown by revenue streams**

According to the CRISIL report, typically, for the passenger vehicles (mass and premium markets) segment, new vehicle sales remain the primary source of income contributing 65-70% of revenue for a dealership, followed by pre-owned vehicle sales contributing 10-15% of revenue, service (regular maintenance & repair) contributing 15-20% of the revenue, and sales of accessories and insurance / finance commission contributing to the remaining portion.

*Typical revenue break-up for a PV dealer (mass and premium markets)*

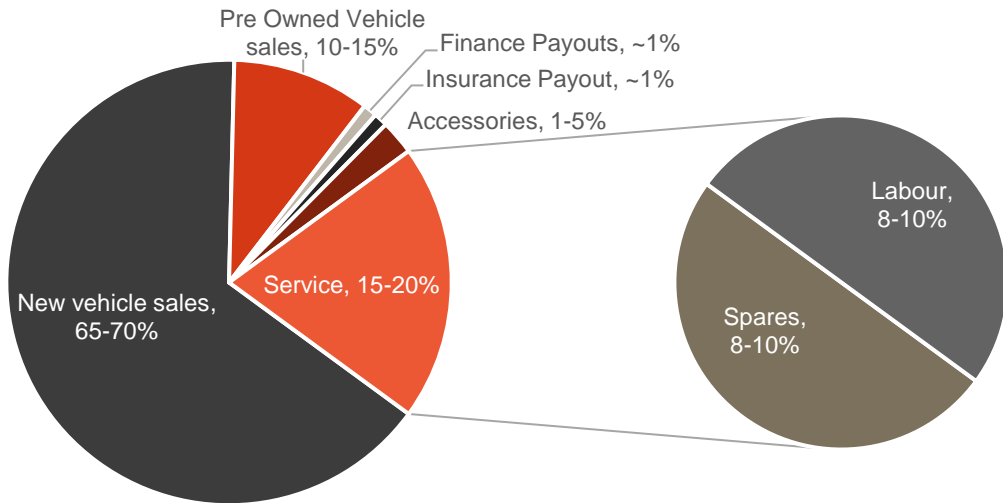

Source: Industry, CRISIL Research

According to CRISIL Research, for a luxury PV dealership, new vehicle sales form approximately 70% share of the overall revenue, while the sale of pre-owned cars accounts for 8-10%. Share of pre-owned car sells in the overall revenue is relatively lower for luxury dealerships compared to mass market/ premium dealerships given the lack of affiliated pre-owned vehicle chain as well as lower share of customers opting for exchange while buying luxury vehicles.

*Typical revenue break-up for a luxury PV dealer*

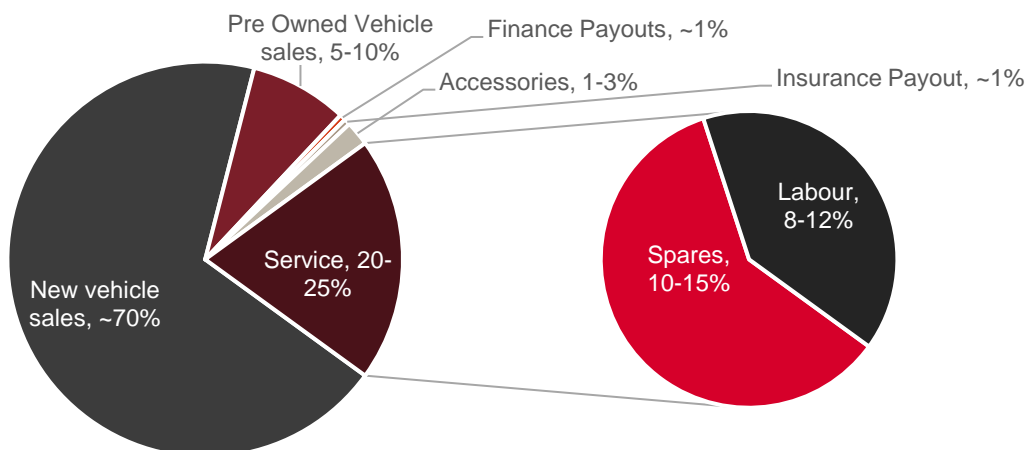

Source: Industry, CRISIL Research

**Overview of each revenue stream**

*Vehicles sales*

Selling vehicles is the primary business for any dealership and naturally forms the lion’s share of overall dealership revenue. This share is also aided by revenue earned from the sale of pre-owned passenger vehicles. The option of

exchanging an old vehicle during the purchase of a new vehicle is predominant in the PV (mass and premium markets) segment, as compared with other segments, with 30-40% of vehicles sold with exchange. Thus, most dealerships provide vehicle exchange schemes that aid the overall vehicle sale revenue share. Luxury vehicle dealers offer an option of assured buyback to new vehicle customers where customers get an option of returning, keeping or exchanging the vehicle after a pre decided number (2, 3 or 5) of years. Nearly 10-15% of the customers opt for this option.

For PVs, the per new vehicle sales margin hovers around 2-4%, varying marginally from manufacturer to manufacturer. Luxury PV manufacturers provide a relatively higher margin of 5-7% per vehicle. Over and above this per new vehicle margin, manufacturers also offer added incentives to dealers, based on the dealer's performance, the number of the vehicles sold by the dealer, target completion, manufacturer market share goals, seasonality, etc. For a well-established large dealer, these incentives can provide an additional margin of 3-5% per vehicle, taking the overall margin achieved per vehicle to 6-8% for a normal PV dealer. A luxury vehicle dealer can achieve an 8-10% per vehicle margin, including incentives.

Margins in the pre-owned vehicle sales segment vary significantly from vehicle to vehicle, depending on the vintage and the state of the vehicle being sold. Typically, margins in the pre-owned vehicle (mass and premium market) sales segment vary from 5-10%. Margins in the pre-owned luxury vehicle is relatively low at approximately 5%, according to CRISIL Research.

#### *Service income*

Income from the service segment is another major source of revenue for the dealer. As vehicles require regular and ongoing service and maintenance, service income is sustainable in nature for dealers. Services revenue can be sub-divided into two major parts: spares and labour. Revenue earned by selling automotive components, parts, lubricants, etc., used for vehicle repair or maintenance is considered spares revenue; the amount charged for the effort or the technical expertise required for the vehicle repair is considered labour revenue. For PV dealers, parts and labour costs contribute equally to the service revenue.

Many PV (mass and premium markets) owners use authorised workshops as long as the vehicle is under warranty. After expiration of the warranty period, PV owners (as opposed to CV owners) are more willing to use official dealership workshops (other than local mechanics) for repairs and maintenance, given the relatively lower running and repair requirements of PVs, as well as customers' willingness to spend relatively more for the safety and proper maintenance of the self-used vehicles. In respect of the luxury PV segment, considerable share of luxury vehicle buyers prefer to go to authorised dealerships for maintenance and repair. All of these are reflected in the higher share of service revenue for PV dealers, as compared with CV dealers. For PV (mass and premium markets) dealers and luxury PV dealers, service forms 15-20% and 20-25% of the revenue, respectively, while for CV dealers, service contributes 10-12% to the overall revenue.

CRISIL Research expects the share of revenue from services to expand going forward on the back of the increased requirement for technical expertise as well as supporting repair infrastructure to repair the latest advanced vehicles that only organised dealerships can provide.

According to the CRISIL Report, the service segment is a high margin segment for a dealership and contributes a sizeable amount to the overall dealer profitability. For a PV (mass and premium market) dealer, margins on the service segment ranges from 45-55% (with margins on spare parts ranging from 20-30% and margins on labour ranging from 60-80%). For a luxury PV dealer, margins on the service segment ranges from 50-60% (with margins on spare parts ranging from 30-35% and margins on labour ranging from 70-80%).

#### *Accessories, finance and insurance pay-outs*

For PV owners, parking sensors and cameras, GPS/ navigation systems, LED headlamps, music system, speakers, seat covers, floor mats, car cover, wheel covers, air fresheners, tyre inflators, etc., form part of the requisite accessories list. Sale of these accessories and value-added services provides an additional source of revenue for the dealers. According to the CRISIL Report, margins on accessories sold for mass and premium PVs range from 15-25% and margins on accessories sold for luxury PVs range from 20-30%.

Financing is an integral part of vehicle purchases. For the PV (mass and premium markets) segment, finance penetration is between 75-80%. For the luxury PV segment, finance penetration is between 70-80%. PV dealers facilitate easy financing for their customers through tie-ups with various banks and NBFCs. Representatives of these financial institutions are stationed in the dealerships and help customers avail financing for their vehicle purchases. For every financing deal done from a PV dealership, the dealer receives a percentage of the financed amount as its commission or

finance pay-out. According to the CRISIL report, typically, PV (mass and premium markets) dealers' commission ranges from 1.0% to 1.5% of the financed amount, while the luxury PV dealers' commission ranges from 0.8% to 1.0% of the finance amount.

When purchasing a new vehicle, the Motor Vehicles Act mandates customers to avail vehicle insurance for damage to any third party involved in case of an accident. Normally, more than 90% of the customers avail insurance through dealers while purchasing a new car. Moreover, most customers get their insurance renewed from the dealers after the expiry of initial coverage. In line with finance pay-outs, dealers also earn a percentage of premium (larger dealers can get up to 19.5% of premium) as a commission from the vehicle insurance done at their dealerships. Larger dealers for the mass and premium PV segment can get up to 19.5% of premium as commission, while dealers for the luxury PV segment can earn between 16-18% of insurance premium as commission.

**Revenue split: Mass/premium segment vs luxury segment**

Revenue Split	Mass/Premium segment	Luxury segment	Comment
New vehicle sales	65-70%	~70%	For both mass market/premium vehicle dealers and luxury car dealers, revenue is primarily earned from new vehicle sales. However, luxury dealers have a higher dependence on new car sales amidst the restricted pre-owned car sales.
Pre-owned vehicle sales	10-15%	5-10%	Pre-owned luxury car market is in a very nascent stage and it is highly unorganised. Limited presence of luxury vehicle dealers in pre-owned vehicle market restricts the revenue contribution from pre-owned vehicle segment
Service	15-20%	20-25%	Higher preference for authorised workshops helps boost the services revenue for luxury segment. Moreover, spares are also relatively costlier and higher technical expertise is expected of the mechanic pushing the services revenue.
Spares	8-10%	10-15%	
Labour	8-10%	8-12%	
Accessories	1-5%	1-3%	Luxury vehicles typically come loaded with necessary accessories, hence the necessity to purchase additional accessories is relatively lower. However, the few accessories which are added by luxury customers are highly priced pushing the revenue earned from accessories for the dealer.
Finance Commission	~1%	~1%	Commission earned by luxury dealers is relatively lower (0.8-1% of financed amount vis 1-1.5% of financed amount for mass market/ premium vehicle dealers) given the significantly higher ticket price. Although bigger luxury PV dealers can get an additional 0.2-0.5% commission.
Insurance Commission	~1%	~1%	Commission % for luxury car dealers is comparable with mass market/ premium vehicle dealers. Insurance premiums are much higher for luxury vehicles, however, volumes are much lower limiting the revenue earned from insurance commission for dealers.

Source: CRISIL Report

**Gross profit split: mass/premium segment vs. luxury segment**

Typical segment-wise share in gross profits

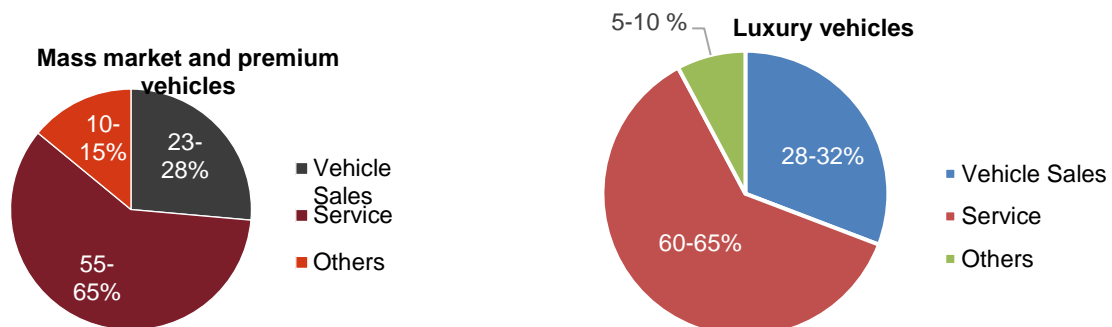

Note: Vehicle sales include new & pre-owned PV sales, others include Accessories, finance pay out, insurance pay out



Detailed section is covered on page 60 and page 70  
 Source: Industry, CRISIL Research

Profitability share	Mass/Premium segment		Luxury segment		Comment
	Segment margin	Share in Total profit	Segment margin	Share in Total profit	
New vehicle sales	4-6%	<b>20-25%</b>	6-8%	<b>25-30%</b>	Per vehicles margins are relatively higher for luxury dealers. Thus contributing slightly higher in profitability. Moreover, higher share of new vehicle sales provides additional kicker.
Pre-owned vehicle sales	5-10%	<b>3-7%</b>	4-6%	<b>1-5%</b>	In the luxury car segment, margins are relatively lower given the higher depreciation in the vehicle price and lack of organised market. However, in terms of actual quantum, the earning per vehicle of luxury car dealers is higher given the much higher ticket price of vehicles.
Service	45-55%	<b>55-65%</b>	50-60%	<b>60-65%</b>	Spares are much costlier in luxury car segment and dealers also earn higher on spares compared to mass market/ premium car dealers. Profitability is comparable on labour. Share in overall profitability is slightly higher for luxury segment.
Spares	20-30%	<b>12-18%</b>	30-35%	<b>20-25%</b>	
Labour	60-80%	<b>42-47%</b>	70-80%	<b>30-40%</b>	
Accessories	15-25%	<b>2-5%</b>	20-30%	<b>1-3%</b>	Luxury vehicles typically come loaded with necessary accessories, hence the necessity to purchase additional accessories is relatively lower. However, the few accessories which are added by luxury customers are highly priced and dealers earn relatively more on those accessories.
Finance Commission	90-100%	<b>4-6%</b>	90-100%	<b>2-5%</b>	Dealers do not have to spend anything additional for earning this commission barring basic facilities provided to the banker. Share in revenue is slightly lower in case of luxury vehicles limiting profitability contribution.
Insurance Commission	90-100%	<b>4-6%</b>	90-100%	<b>2-5%</b>	Dealers do not have to spend anything additional for earning this commission barring basic facilities provided to the insurer. Share in revenue is slightly lower in case of luxury vehicles limiting profitability contribution.

## Commercial vehicles dealership landscape in India

### Revenue streams for a CV dealership

For a typical CV dealer, there are three major revenue streams.

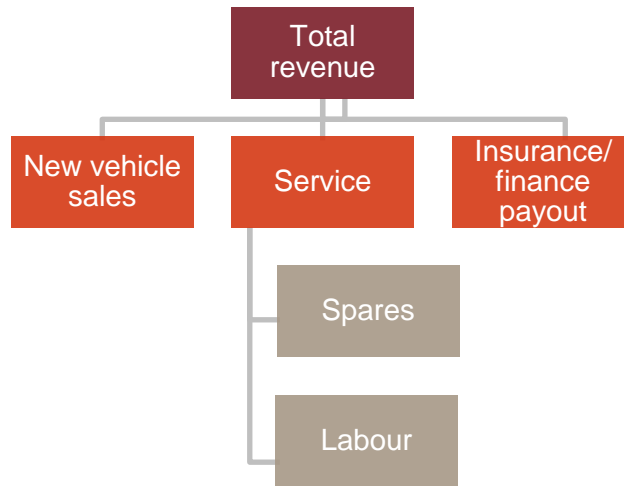

Source: CRISIL Report

**Increase in CV dealerships in India**

CV dealerships form approximately 10% of overall dealerships in India and contribute to approximately 15% of the overall touchpoints. Dealership expansion was spearheaded by market leader Tata Motors to strengthen its foothold, especially in southern India.

Number of CV dealerships

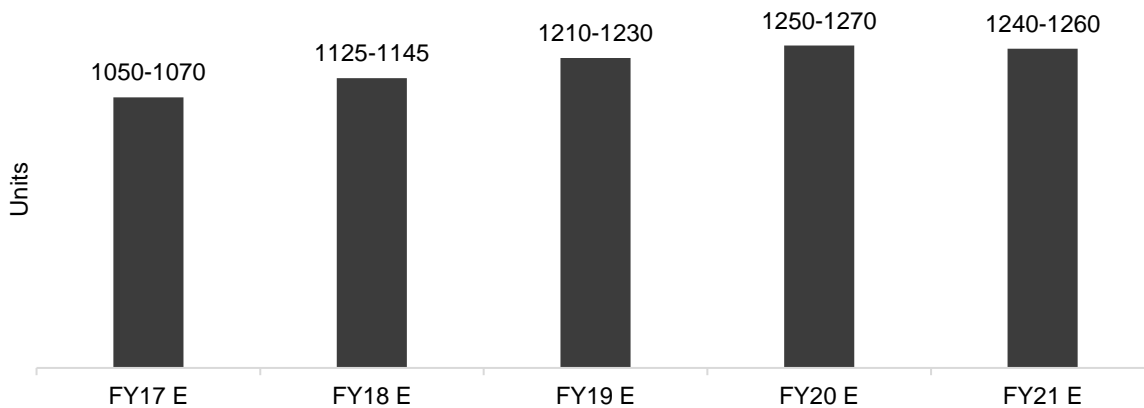

Source: Industry, CRISIL Research

**Breakdown by revenue streams**

Typical revenue break-up for a CV dealer

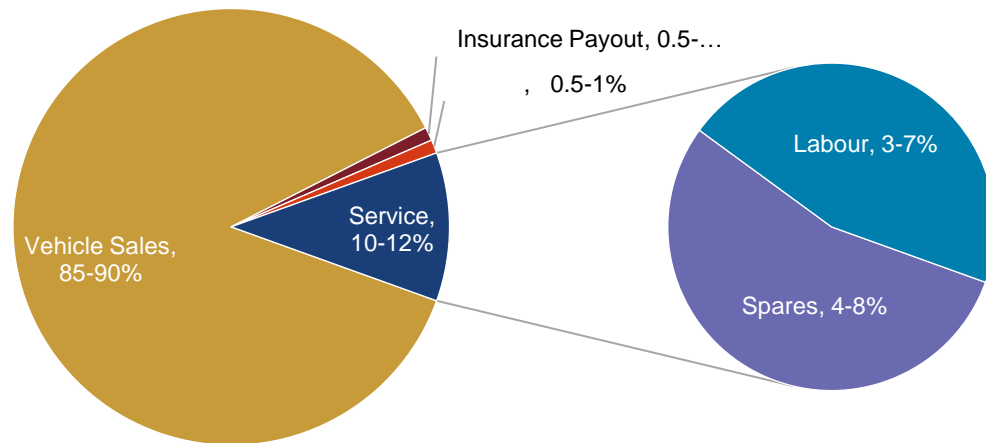

Source: Industry, CRISIL Research

### **Overview of each revenue stream**

#### *Vehicle sales*

According to CRISIL Research, for a typical CV dealership, 85-90% of revenue is contributed by new vehicle sales. In the CV industry, the sale of pre-owned vehicles is mainly undertaken by independent brokers, and its contribution to CV dealers is insignificant. Given the high running cost and extended replacement cycles in this industry, the association of pre-owned vehicle dealerships with new vehicle dealerships is relatively uncommon.

For CVs, the per new vehicle sales margin hovers around 2-4%. M&HCVs have higher margin than LCVs. Similar to the PV industry, manufacturers also offer added incentives to dealers on top of the per vehicle margin. For a well-established large dealer, these incentives can provide an additional margin of 2-4% per vehicle, taking the overall margin achieved per vehicle to 4-6% for a normal PV dealer.

#### *Services income*

In CV dealerships, income from services is relatively limited to only 10-12% of overall revenue. Fleet operators normally use authorised workshops only during the AMC (annual maintenance contract) period, and thereafter prefer their own workshops or non-authorised mechanics. For CV dealers, labour contributes 45-50% of services revenue, and spares the rest.

CRISIL Research, however, expects the share of revenue from services to expand on the back of increased demand for technical expertise to repair the latest advanced vehicles, which only authorised dealerships can provide. Over the years, for a safer, more efficient drive, the use of electronic engine control unit and various sensors in CVs has surged. Moreover, the implementation of stringent emission norms by the Government has propelled the use of sophisticated technology in vehicles. These technological advances necessitate sophisticated IT-backed tools to repair vehicles. Thus, in such cases, non-authorised mechanics can provide only limited assistance.

According to the CRISIL Report, the service segment is a high margin segment for a CV dealership and contributes a sizeable amount to the overall dealer profitability. For a CV dealer, margins on the service segment ranges from 45-50% (with margins on spare parts ranging from 15-20% and margins on labour ranging from 60-70%).

#### *Finance/insurance pay-out*

Financing of vehicles is an integral part of vehicle purchase. For the CV segment, finance penetration is above 95%. For every financing deal, the vehicle dealer receives a percentage of the financed amount as commission or finance pay-out – this contributes 0.5-1% of dealer revenue. For insurance purchases, many fleet operators have their own connection with insurance companies and do not purchase insurances through dealers. For those that purchase insurances through dealers, dealers earn a percentage of insurance premium as commission– this contributes 0.3-1% of dealer revenue.

### **Gross profit split for CV dealership**

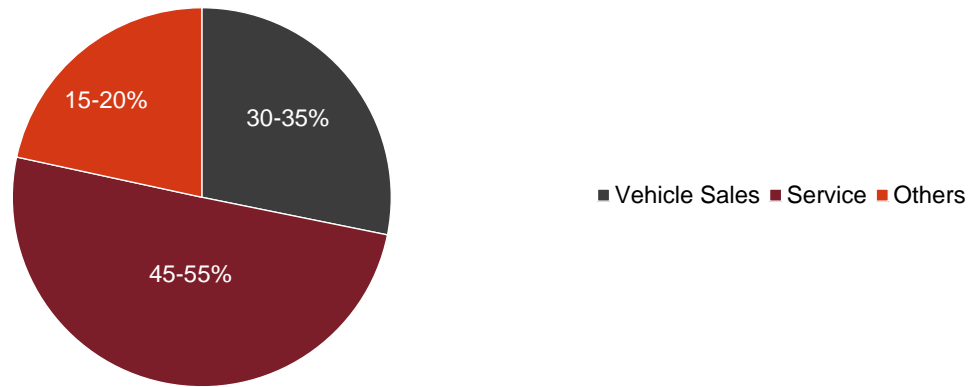

Source: Industry, CRISIL Research

## Growth drivers and key trends in automobile dealerships (PV and CV) in India

### *Digital transformation to aid dealer profitability*

Digital advancement is supporting the automotive dealership in customer outreach, improving customer buying experience, increasing transparency in vehicle valuation and pricing, and improving customer retention. In turn, it is helping dealers expand their reach and maintain customer connect indirectly boosting dealer revenues. Facilitating technology enabled services and digital offerings is leading to better customer satisfaction and increased customer retention. Moreover, it is also helping optimize dealership costs and reduce their overheads strengthening dealership margins. CRISIL Research expects the dealers who have invested in the digital technology to have an edge over other dealers in the longer run.

### *Expected growth in new PV and CV sales*

Improvement in economic scenario, expected GDP growth, subdued inflation, improvement in disposable income, intermittent vehicle launches, expanding financing support is expected to provide a push to the new PV and CV sales. In addition, increasing exports (through realignment of global supply chains and the government's production-linked-incentive scheme), government's focus on infrastructure investments (through the NIP) and initiation of commercial mining in India are likely to steer growth for the CV industry sales. CRISIL Research expects (i) the sales of new PV clock 8-10% CAGR from a low base in fiscal 2021 to reach 4.1-4.3 million vehicles by fiscal 2026 and (ii) the sales of new CV to clock 12-14% CAGR from a low base in fiscal 2021 to reach 1.0-1.1 million vehicles by fiscal 2026. This growth in sales will provide a boost to the dealer revenues going ahead.

### *Continued traction for pre-owned vehicles*

Increased need for personal mobility, rising aspirations of customers, growing disposable income, lowering replacement cycles and increasing financial penetration are expected to drive the growth pre-owned PV sales segment. The expanding share of the organised segment with facilitating digital technology will provide an added boost to demand. According to the CRISIL Report, pre-owned PV industry (mass and premium markets) is expected to grow at a CAGR of 12-14% between Fiscal 2021 to Fiscal 2025, boosting the dealership revenues.

### *Rise in average vehicle prices*

OEMs undertake an annual vehicle price hike every year to compensate for the rise in material costs and costs required to comply with changing safety and emission norms. Additionally, the premiumisation trend in the mass market/ premium PV industry is also expected to provide a kicker to the average vehicle prices supporting dealer revenue growth. Increase in share of the costlier premium vehicles, CNG, hybrid and electric vehicles will also push the vehicle prices upwards. Moreover, this will also aid the accessories revenue as well.

### *Shift towards authorized workshops*

In recent year, customer preference for authorised workshops is increasing with increase in latest technological gadgets being used in the new age vehicles. These vehicles require higher technical expertise as well as latest tech infrastructure to repair, which most local mechanics lag behind. Accordingly, higher number of customers have to depend on the

authorised workshops for maintenance and repair of their vehicles. Moreover, dealers also offer attractive extended warranty / AMC schemes to the customers incentivising them to opt for an authorised dealership.

### ***Rising financial penetration***

Increasing support from financiers, subdued interest rates, rising LTV is expected to augment finance penetration levels. This is expected to aid dealership revenue in two ways, one by bringing newer customers/ first time buyers into the market backing dealership revenue growth and second by providing an additional revenue from the financing commission dealers earn on the financed amount.

### ***Added advantages for large dealers (PV and CV)***

Large luxury dealers, given the sheer size of the business, receive added benefits as well as higher economies of scale backing their better finances. A few of the major advantages are:

- Preference of OEs to partner with larger organised dealers
- Better negotiations with manufacturers;
- Better deals with vendors for supplies and spare parts;
- Greater share of service revenue (higher service to sale ratio);
- Better insurance/ finance deals;
- Higher customer retention;
- Better customer reach through call centre and wider network coverage;
- Ability to provide value-added services; and
- Multiple brand dealerships at single location.

### **Key players in Indian automobile dealerships**

The below tables compare a few of the noteworthy large PV and CV dealership groups in India. Most of these groups have dealerships of multiple OEMs, comprising the PV (mass and premium markets), luxury PV and CV segments.

Player dominance varies with vehicle segment and OEMs. According to the CRISIL Report, Group Landmark is one of the leading premium automotive dealership groups in India, being the number one dealer in India for Mercedes-Benz, Honda and Jeep, in terms of wholesale sales for Fiscal 2021, and the top contributor to Volkswagen retail sales for calendar year 2020. In addition, Group Landmark was the third largest dealership for Renault, in terms of wholesale sales contribution for calendar year 2020.

In Fiscal 2021, Group Landmark contributed 13.41%, 5.20%, 21.63%, 5.95% and 4.83% of the domestic sales of Mercedes-Benz, Honda, Jeep, Volkswagen and Renault, respectively, according to the CRISIL Report.

### *Player-wise OEM presence*

		Landmark Cars Ltd	Advaith Motors	AMPL	Deutsche Motoren	Jubilant	Kataria Automobiles	KUN Auto Company	KUN Motor Company	Navnit Motors
PV	Maruti			✓			✓			✓
	Hyundai		✓					✓		
	Mahindra			✓						
	Honda	✓								
	Renault	✓								
	VW	✓								
	Jeep	✓								
	MG					✓				
	JLR									✓
	Mercedes-Benz	✓	✓							
	BMW				✓				✓	✓
	Audi					✓				
	Ferrari									✓
	Mini				✓				✓	✓
	Porsche						✓			✓
Rolls Royce								✓		
CV	Tata (CV)									
	BharatBenz						✓			
	Ashok Leyland	✓		✓						

	Landmark Cars Ltd	Advaith Motors	AMPL	Deutsche Motoren	Jubilant	Kataria Automobiles	KUN Auto Company	KUN Motor Company	Navnit Motors
<b>No. of Brands</b>	6	2	3	2	2	3	1	3	6

Note: AMPL- Automotive manufacturers Pvt Ltd; Data as of Fiscal 2021.

Source: Industry, company website, CRISIL Research

Player-wise financial comparison (fiscal 2020)

	Landmark Cars Ltd	Advaith Motors#	AMPL	Deutsche Motoren	Jubilant	Kataria Automobiles	KUN Auto Company	KUN Motor Company	Navnit Motors
<b>Year of commencement</b>	1998	1998	1948	2007	2009	1984	1998	2006	1994
<b>Mass/Premium</b>	✓	✓	✓		✓	✓	✓		✓
<b>Luxury</b>	✓	✓		✓	✓	✓		✓	✓
<b>CV</b>	✓		✓			✓			
<b>Outlets</b>	50+	50+	50+	3+	5+	95+	7+	10+	15+
<b>Opr Rev. (Rs bn)</b>	22.2	14.3	54.5	1.4	1.7	20.2	14.4	9.1	11.3
<b>Opr Rev. 3 yr CAGR</b>	49%**	-3%	-1%	-33%	-31%	-4%	6%	9%	-6%
<b>EBITDA margin (%)</b>	3.7%	3.8%	2.4%	13.6%	12.7%	4.5%	4.3%	6.6%	-1.4%
<b>Net profit ratio (%)</b>	-1.3%	0.5%	0.4%	5.3%	1.5%	0.6%	1.3%	3.4%	-5.2%
<b>D/E</b>	2.1	4.5	0.3	1.9	1.9	3.9	3.3	0.5	NM

Note: # : Data as of FY 2019, \*\*:

Automark Motors Private Limited, Landmark Automobiles Private Limited were not part of Landmark Cars Limited in FY18 and Landmark Commercial Vehicles Private Limited was not part of Landmark Cars Ltd till September, 2018. LAPL and AMPL were consolidated in FY19 and LCVPL was consolidated in Landmark Cars Limited w.e.f. October 1, 2018. Fiscal 2021 data is currently not available for all players. ROCE has been calculated as EBIT/capital employed.

Source: MCA, CRISIL Research

## OUR BUSINESS

Some of the information contained in this section, including information with respect to our strategies, contain forward-looking statements that involve risks and uncertainties. You should read the section titled “Forward-Looking Statements” on page 19 for a discussion of the risks and uncertainties related to those statements and also the section titled “Risk Factors”, “Restated Consolidated Financial Information” and “Management’s Discussion and Analysis of Financial Position and Results of Operations” on pages 28, 202 and 272, respectively, for a discussion of certain factors that may affect our business, results of operations and financial condition. The actual results of the Company may differ materially from those expressed in or implied by these forward-looking statements.

Unless otherwise indicated, industry and market data used in this section has been derived from the CRISIL Report which has been commissioned by us in connection with the Offer. Unless otherwise indicated, all financial, operational, industry and other related information derived from the CRISIL Report and included herein with respect to any particular year, refers to such information for the relevant year.

Our fiscal year ends on March 31 of each year, and references to a particular fiscal period are to the twelve months ended March 31 of that year. References to a six-month period or “Half Year” are to the six months ended September 30 of a particular fiscal year. Unless otherwise specified or as the context requires, financial information included in this section for Half Year Fiscal 2022, Fiscal 2021, Fiscal 2020 and Fiscal 2019 is derived from our Restated Consolidated Financial Information.

Unless otherwise stated, in this section references to “Group Landmark”, “we”, “us”, and “our” are to Landmark Cars Limited and its Subsidiaries; and references to the “Issuer” are to Landmark Cars Limited on a standalone basis.

### Overview

We are a leading premium automotive retail business in India with dealerships for Mercedes-Benz, Honda, Jeep, Volkswagen and Renault. (Source: CRISIL Report, December 2021). We also cater to the commercial vehicle retail business of Ashok Leyland in India. We have a presence across the automotive retail value chain, including sales of new vehicles, after-sales service and repairs (including sales of spare parts, lubricants and accessories), sales of pre-owned passenger vehicles and facilitation of the sales of third-party financial and insurance products. We started our operations and opened our first dealership for Honda in CY1998, and we have expanded our network to include 112\* outlets in 8 Indian states, comprised of 61 sales showrooms and outlets and 51\* after-sales service and spares outlets, as of September 30, 2021. We are focused on the premium and luxury automotive segments. CRISIL Research expects the premium segment to grow at a CAGR of 10-12% CAGR from Fiscal 2021 to Fiscal 2026, while the luxury segment is expected to grow at a CAGR of 20-22% during the same period. (Source: CRISIL Report, December 2021). We were number one dealer in India by sales volumes of new vehicles for Mercedes-Benz (in Fiscal 2021), Honda (in Fiscal 2021), Volkswagen (in CY 2020) and Stellantis (Jeep) (in Fiscal 2021), and we were the third largest dealer by sales volume for Renault (in CY2020).

\*includes acquisition of 4 after sales service and spares outlets pursuant to acquisition of Shaman Wheels Private Limited w.e.f. October 1, 2021.

### New Vehicle Sales

In the six months ended September 30, 2021 and in Fiscal 2021, we sold 8,295 and 13,282 new vehicles, respectively, including new passenger vehicles of Mercedes-Benz, Honda, Volkswagen, Jeep and Renault and new commercial vehicles of Ashok Leyland. Our consolidated revenue from new vehicle sales were ₹11,352.91 million and ₹14,455.44 million, respectively, in the six months ended September 30, 2021 and in Fiscal 2021, and comprised 80.35% and 73.90%, respectively, of our consolidated total revenue from operations in those periods.

The following table sets forth (i) the volume of new vehicles that we sold for each OEM in the six months ended September 30, 2021 and in Fiscal 2021, (ii) the year we opened our first dealership with each particular OEM (iii) our market position and (iv) percentage of passenger vehicles sold with respect to that OEM in 2021 or Fiscal 2021.

OEM	Half Year Fiscal 2022 <sup>(1)</sup>	Fiscal 2021 <sup>(1)</sup>	Geographic Network	Year First Dealership Established	Market Position in India <sup>(2)</sup>	% of India Sales for OEM sold by Landmark <sup>(3)</sup>
Mercedes-Benz	921	1,133	Gujarat, Madhya Pradesh, Maharashtra, West Bengal	2008	Number 1 (for Fiscal 2021)	13.41%
Honda	2,414	4,500	Gujarat, Madhya	1998	Number 1	5.20%

OEM	Half Year Fiscal 2022 <sup>(1)</sup>	Fiscal 2021 <sup>(1)</sup>	Geographic Network	Year First Dealership Established	Market Position in India <sup>(2)</sup>	% of India Sales for OEM sold by Landmark <sup>(3)</sup>
			Pradesh		(for Fiscal 2021)	
Jeep	1,473	1,311	Punjab, Delhi, Maharashtra, Haryana, Uttar Pradesh	2017	Number 1 (for Fiscal 2021)	21.63%
Volkswagen	673	1,196	Haryana, Gujarat, Delhi	2009	Number 1 (for CY2020)	5.95%
Renault	2,172	4,261	Punjab, Haryana, Maharashtra	2016	Number 3 (for CY2020)	4.83%
Ashok Leyland <sup>(4)</sup>	642	881	Gujarat	2012	N/A	1.91%

Note:

<sup>(1)</sup> Number of new vehicles sold in the period.

<sup>(2)</sup> We were the number one dealer in India for Mercedes-Benz, Honda and Jeep in terms of wholesale sales for Fiscal 2021 and was the top contributor to Volkswagen retail sales for calendar year 2020. We were the third largest dealership in India for Renault in terms of wholesale sales contribution for calendar year 2020. (Source: CRISIL Report, December 2021).

<sup>(3)</sup> For Fiscal 2021, we contributed 13.41%, 5.20%, 21.63%, 5.95% and 4.83% of the domestic sales of Mercedes-Benz, Honda, Jeep, Volkswagen and Renault, respectively.

<sup>(4)</sup> Our Ashok Leyland dealership has 2 outlets in Gujarat from which we sell medium and heavy commercial vehicles.

Our vehicle dealership network is spread across 31 cities in eight states and union territories including Maharashtra, Uttar Pradesh, Gujarat, Haryana, Madhya Pradesh, Punjab, West Bengal and the National Capital Territory of Delhi. These states constituted more than 51% of Indian vehicle demand in Fiscal 2021. (Source: CRISIL Report, December 2021). In addition, we have an online presence through our website for Group Landmark, websites for our individual dealerships and the websites of our OEMs to showcase our brands including the latest model launches by our OEM partners and to facilitate lead generation. We began taking bookings online through our website for Group Landmark in June 2021 which is leading to monthly sales each month.

### **Expansion into Pure EV Sales**

We have recently signed a letter of intent with the automaker BYD, a leading player in the global EV market (according to the CRISIL Report, December 2021), for our Company to be their dealer in the National Capital Region (Delhi) and Mumbai in respect of their electric passenger vehicles.

### **After-Sales Service and Spare Parts**

Our after-sales service and spare parts offerings at each of our dealerships comprise repair and collision repair services and include both warranty work, insurance claim work and customer paid services. We operate as authorized service centers for Mercedes-Benz, Honda, Volkswagen, Jeep, Renault and Ashok Leyland, and we provide after-sales service and repairs through 51\* after-sales service and spares outlets, as of September 30, 2021. During the six months ended September 30, 2021 and Fiscal 2021, Fiscal 2020 and Fiscal 2019, we serviced 127,337, 213,755<sup>^</sup>, 280,952<sup>^</sup> and 261,670<sup>^</sup> passenger vehicles, respectively, and 5,343, 7,713, 10,088 and 10,236 commercial vehicles, respectively. In the six months ended September 30, 2021, Fiscal 2021, Fiscal 2020 and Fiscal 2019, our after-sales service and spare parts revenues was ₹2,430.15 million, ₹4,229.56 million, ₹4,806.40 million and ₹4,602.16 million, respectively. In addition, as authorized dealers for Mercedes-Benz, Honda, Volkswagen, Jeep, Renault and Ashok Leyland, we also sell spare parts, lubricants, accessories and other products at our after-sales service and spares outlets. In the six months ended September 30, 2021 and in Fiscal 2021, Fiscal 2020 and Fiscal 2019, we earned an average of ₹18,316, ₹19,098, ₹16,515 and ₹16,926 respectively, from each vehicle serviced, and we serviced an average of 16, 17, 17 and 12 vehicles for every new vehicle sold in the respective periods.

\*includes acquisition of 4 after sales service and spares outlets pursuant to acquisition of Shaman Wheels Private Limited w.e.f. October 1, 2021.

<sup>^</sup> includes service count of dealership for former OEM partner.

### **Pre-owned Passenger Vehicle Sales**

We buy and sell pre-owned passenger vehicles at each of our dealerships. We operate on two business models: (1) we facilitate the sale of used vehicles through our appointed panel of agents on a commission basis; and (2) we also take the vehicles on our books for sale after any needed refurbishment. We also receive an incentive from our OEMs for used vehicles traded in for new vehicles; this incentive or over-allowance is available to us as a new car dealer and helps us with closing these transactions. We have also implemented a digital SaaS platform developed by Sheerdrive, an auto technology start-up company in which we held a 19.97% equity interest (as at September 30, 2021), in our pre-owned



car business. Sheerdrive's technology platform enables digital evaluation and real time used car prices, which we believe will help drive transparency, accuracy and velocity of used car transactions, and will help drive our strategy of combining our physical presence with digital scale and speed.

### **Third-party financial and insurance products**

As a value add-on to our passenger vehicle sales, we facilitate the sale of third-party financial products including insurance policies and vehicle finance through our dealerships. Each of our dealerships offer finance and insurance from our recommended financial service providers, banks and insurance companies with which we have commission arrangements. We typically receive a portion of the cost of the financing paid or sum assured by the customer for each transaction as a fee from the finance or insurance provider. We believe that increasing the penetration of finance and insurance product sales will further drive profitability of our overall business.

### **Key financial information**

Our financial goal is to maximize our profit per passenger vehicle sold / serviced from the various revenue streams available while providing our customers with an attractive sales % service package. Accordingly, our management tracks all earnings under passenger vehicle sales and service on an overall basis. For more information, see “*Management's Discussion and Analysis of Financial Position and Results of Operations*” on page 272.

The table below shows the contribution of each of our business segments to our revenue as well as the EBITDA and EBITDA margins for passenger vehicle sales and other operating revenue, for commercial vehicle sales and for after-sales service and spare parts revenue during the six months ended September 30, 2021 and Fiscal 2021, Fiscal 2020 and Fiscal 2019.

(in ₹ millions, except percentages and vehicle numbers)

	<b>Half Year Fiscal 2022</b>	<b>Fiscal 2021</b>	<b>Fiscal 2020</b>	<b>Fiscal 2019</b>
<b>Sales Volumes</b>				
Number of new vehicles sold	8,295	13,282	16,730	22,118
Number of vehicles serviced	132,680	221,468	291,040	271,906
<b>Vehicle sales and other operating revenue</b>				
New vehicles	11,461.83	14,722.76	16,912.52	23,198.08
Financial products (insurance and vehicle finance)	90.37	139.48	208.01	262.24
Pre-owned vehicles sold	82.09	353.65	231.42	163.36
<b>Total revenue</b>	<b>11,634.29</b>	<b>15,215.89</b>	<b>17,351.95</b>	<b>23,623.68</b>
EBITDA	254.11	368.14	-96.93	14.04
EBITDA margin	2.18%	2.42%	-0.56%	0.06%
<b>After-sales service and spare parts revenue*</b>				
<b>Total revenue</b>	<b>2,494.13</b>	<b>4,345.15</b>	<b>4,834.19</b>	<b>4,641.50</b>
EBITDA	460.57	771.12	865.83	804.89
EBITDA margin	18.47%	17.75%	17.91%	17.34%
Add: Other income	69.51	102.39	103.19	80.98
<b>Less: Unallocable expense^</b>	<b>7.67</b>	<b>41.02</b>	<b>40.14</b>	<b>13.64</b>
<b>Total EBITDA</b>	<b>776.52</b>	<b>1,200.63</b>	<b>831.95</b>	<b>886.27</b>
<b>Total EBITDA Margin</b>	<b>5.47%</b>	<b>6.11%</b>	<b>3.73%</b>	<b>3.13%</b>

Notes:

\* After-sales service and spare parts revenue includes sales spare parts, lubricants, accessories and others.

^ Unallocable expense comprises of loss on property, plant and equipment sold /written off, expenditure on CSR and donations and contributions.

For information about non-GAAP financial measures as set forth in the table above, see “*Management's Discussion and Analysis of Financial Position and Results of Operations – Key Performance Indicators and Non-GAAP Financial Measures*” on page 289.

## **Our Strengths**

We possess a number of competitive strengths, which enable us to successfully execute our business strategies, which are set forth below.

### ***Leading automotive dealership for major OEMs with a strong focus on high growth segments***

We are a leading premium automotive retail business in India with dealerships for Mercedes-Benz, Honda, Jeep, Volkswagen and Renault. (Source: CRISIL Report, December 2021). We started our operations and opened our first dealership for Honda in 1998, and we have expanded our network to include 112\* outlets in eight Indian states, comprising 61 sales outlets and 51\* after-sales service and spares outlets, as of September 30, 2021. We were the number one dealer in India for Mercedes-Benz, Honda and Jeep in terms of wholesale sales for Fiscal 2021 and were the top contributor to Volkswagen retail sales for calendar year 2020. In addition, we were the third largest dealership in India for Renault in terms of wholesale sales contribution for calendar year 2020. In Fiscal 2021, we contributed 13.41%, 5.20%, 21.63%, 5.95% and 4.83% of the domestic sales of Mercedes-Benz, Honda, Jeep, Volkswagen and Renault, respectively. (Source: CRISIL Report, December 2021).

*\*includes acquisition of 4 after sales service and spares outlets pursuant to acquisition of Shaman Wheels Private Limited w.e.f. October 1, 2021.*

We have been honoured with awards and recognitions by our OEM dealership partners including, for example, Rank 3 in Best Volume Contribution by Renault in 2021, Most Innovative Marketing – Dealer Award by Volkswagen in 2019, HR Partner of the Year by Mercedes-Benz in 2013 and Sales Satisfaction Award by Honda in 2015.

Our longstanding relationships with our OEM partners and our market leadership positions offers us several competitive advantages including:

- opportunities from the OEMs allowing us to expand our business into new cities and geographies;
- sharing infrastructure and manpower across brands to increase margins;
- attracting suitable inorganic dealership acquisition targets (with the support of the OEMs);
- opportunities to expand across our business verticals like after-sales service, sales of pre-owned vehicles and sales of financial and insurance products;
- attracting talented sales and technical personnel;
- executing large scale marketing and advertising campaigns; and
- centralising certain backend and support functions all of which leads to economies of scale and margin improvement.

In addition, our business focus has been on the fast-growing premium and luxury segments of the Indian passenger vehicle market. CRISIL Research expects the premium segment to grow at a CAGR of 10-12% CAGR from Fiscal 2021 to Fiscal 2026, while the luxury segment is expected to grow at a CAGR of 20-22% during the same period. (Source: CRISIL Report, December 2021).

In addition, we have recently entered into a letter of intent with the automaker BYD, a leading player in the global EV market (according to the CRISIL Report, December 2021), for our Company to be their dealer in the National Capital Region (Delhi) and Mumbai in respect of their electric passenger vehicles. We also offer the electric passenger vehicles of Mercedes-Benz.

Furthermore, the UV segment volumes are expected to grow at a CAGR of 9% to 11% from Fiscal 2021 to Fiscal 2026. (Source: CRISIL Report, December 2021). All five of our OEM partners in passenger vehicles are focused on the UV market, particularly SUVs, with additional models planned for release in India.

### ***Growing presence in after-sales segment leading predictable growth in revenues and superior margins***

Our services and repair offerings at each of our dealerships comprise repair and collision repair services and include warranty work, insurance claim work and customer paid services. We operate as authorized service centers for Mercedes-Benz, Honda, Volkswagen, Jeep, Renault and Ashok Leyland, and we provide after-sales service and repairs through our 51\* after-sales service and outlets across eight Indian states. We also sell spare parts, lubricants, accessories and other products from these outlets.

*\*includes acquisition of 4 after sales service and spares outlets pursuant to acquisition of Shaman Wheels Private Limited w.e.f. October 1, 2021.*

Our after-sales service and spares business provides a stable revenue stream and contributes to higher-margin revenues

at each of our dealerships, which helps mitigate the cyclicity that has historically impacted some players of the automotive sector. Our after-sales service and spares revenue contributed to 17.20%, 21.62%, 21.66% and 16.28% of our revenue from operations and our after-sales service and spare parts EBITDA contributed to 59.31%, 64.23%, 104.07% and 90.82% of our EBITDA during the six months ended September 30, 2021 and Fiscal 2021, Fiscal 2020 and Fiscal 2019, respectively. In the six months ended September 30, 2021 and Fiscal 2021, Fiscal 2020 and Fiscal 2019, our EBITDA margins from our after-sales service and spares business were 18.47%, 17.75%, 17.91% and 17.34%, respectively.

In Fiscal 2021, we earned an average of ₹19,098 from each vehicle serviced, and we serviced an average of 17 vehicles for every new vehicle sold in the period. In the six months ended September 30, 2021, we earned an average of ₹18,316 from each vehicle serviced, and we serviced an average of 16 vehicles for every new vehicle sold in the period. This has resulted in growth in our average revenue per vehicle serviced from Fiscal 2020 and Fiscal 2019, during which we earned an average of ₹16,515 and ₹16,926 per vehicle serviced, respectively.

Our OEMs offer manufacturers' warranties and maintenance programs packaged with vehicle' sales and, generally, only permit warranty work to be performed at their authorized service centers such as ours. This creates a significant barrier to entry for new competitors. In addition, our emphasis on selling extended warranties and packaged service contracts has bolstered our after-sales service business in each of our dealerships by helping us to retain customers beyond the term of the standard manufacturer warranty period.

For information about our strategy to expand our after-sales service business, see "--Our Strategies--Expand our after-sales service businesses" on page 140.

### ***Comprehensive business model capturing entire customer value-chain***

Our business caters to the entire customer value-chain including retailing new vehicles, servicing and repairing vehicles, selling spare parts, lubricants and other products, selling pre-owned passenger vehicles and the distribution of third party financial and insurance products. We benefit from the synergies of these complementary businesses as well as increased customer retention from servicing our customer's various automotive needs. As the number one dealer in India in terms of wholesale sales in Fiscal 2021 by sales volumes for new passenger vehicles for Mercedes-Benz, Honda and Jeep and the top contributor in terms of retail sales for Volkswagen in calendar year 2020, there is ample opportunity for new business in other segments by utilizing our synergies in complementary businesses. For example, each sale of a new or pre-owned passenger vehicle provides us the opportunity to sell the customer an extended service contract or a financial product such as vehicle financing and insurance. Customers who purchase vehicles from us also entrust us with the servicing and repairs of their vehicles at our dealership's authorized service centers through products such as extended warranties. We believe that we have an opportunity to grow the number of extended warranties sold during the next few years through the efforts of our service marketing team. Our service centers are also points of sale for spare parts, lubricants and other products such as accessories as well as value added services such as interior cleaning, polishing and sales of extended warranties. Further, our service centers act as points of renewal for insurance policies and extended warranties from end of manufacturer warranty period onwards. Our service centers also help to ensure customer retention within our network as OEMs require vehicles under warranty to be serviced at authorized service centers. Further, we also use our service centers to source pre-owned passenger vehicle opportunities for which we have sales teams stationed at our larger service centers.

### ***Robust business processes leveraging technological innovation and digitalization***

We have established robust business processes which assists us in reducing costs and increasing efficiency as well as ensuring faster operationalization of new facilities. These processes ensure our ability to replicate our successes as we expand organically and in the new businesses that we acquire.

We have established processes for operationalizing new outlets including purchasing inventory, selecting and leasing premises and hiring sales and technical personnel. Further, we also focus on customer processes and data to provide insights into customer engagement. We target campaigns to existing customers by email, online campaigns and social media for upgrades, after-sales service offers and loyalty benefits. We also provide customers third party offers and loyalty benefits when they enter into after-sales service transactions with us and checkout rewards on our websites.

We use the online presence from our website for Group Landmark, websites for our individual dealerships and the websites of OEM partners to showcase our brands and vehicle models including latest models launched by OEM partners.

We also use our online presence for lead generation for new vehicle sales by allowing our customers to book test drives

and appointments with our sales agents and to provide a convenient platform to book service appointments.

Further, our customers are able to use our websites to track their vehicle maintenance schedules and reach out to us for any complaints or queries. In addition to our websites, we have launched a chatbot on a leading instant messaging application to resolve customer queries and to book after-sales service appointments.

We also have made forays into technology and platforms through our investments in Chatpay Commerce Private Limited (known as “**Pitstop**”) and Sheerdrive Private Limited (“**Sheerdrive**”).

As of September 30, 2021, we held a 9.79% equity interest in Pitstop (on a fully-diluted basis), which aims to be a multi-brand car service and repair provider that focuses on reskilling and training technicians and providing access to the necessary modern equipment and OES and white labelled spare parts. We are working on integrating the technology from Pitstop to improve efficiency and customer convenience for our after-sales service customers, the initiatives we are working on are:

- vehicle pickup and drop-off, wherein customer details and vehicle details are available in real time with the customer on the phone;
- calling and confirmation of service appointments through the online and mobile applications.
- confirmation of service estimates through the online service portal and mobile applications; and
- selling value added services and additional essential jobs not part of original service requests through direct marketing through our online service portal and mobile applications.

In addition, as of September 30, 2021, we held a 19.97% equity interest in Sheerdrive (on a fully-diluted basis), an auto technology start-up. Sheerdrive focused on used car transactions at new car dealerships by leveraging its digital SaaS platform that enables digital evaluation and real time used car prices. We believe that the platform will drive transparency, accuracy and velocity of used car transactions. We have implemented Sheerdrive’s platform at our dealerships in our pre-owned passenger vehicles business. The investment fits in our strategy of combining our physical presence with digital scale and speed.

For information about our strategy to invest in technology and digitalization to drive our business processes, see “--Our Strategies-- Continue to invest in technology and digitalizing sales and service channels” on page 141.

### ***Profitable and improving balance sheet***

In the six months ended September 30, 2021 and Fiscal 2021, Fiscal 2020 and Fiscal 2019, our total income was ₹14,197.93 million, ₹19,663.43 million, ₹22,289.33 million and ₹28,346.16 million, respectively; our EBITDA was ₹776.52 million, ₹1,200.63 million, ₹831.95 million and ₹886.27 million, respectively; and our profit/(loss) after tax was ₹279.47 million, ₹111.48 million, ₹ (289.39) million and ₹ (244.28) million, respectively.

Fiscal 2020 reflected dull consumer sentiment coupled with inventory corrections for required BS VI emissions upgradation. The COVID-19 pandemic further impacted growth levels in Fiscal 2021 with the national lockdowns and work from home orders severely impacting the Indian economy and automotive industry. Despite a decline in revenues from operations between Fiscal 2019 and Fiscal 2021, in line with industry trends, our operations continued to be profitable during this period.

Further, in this same difficult period between Fiscal 2019 and Fiscal 2021, we made efforts to improve our balance sheet as reflected in: (i) our Net Debt / EBITDA Ratio that improved to 2.54 times in Fiscal 2021 from 3.90 times in Fiscal 2020 and 4.99 times in Fiscal 2019; (ii) our EBITDA Margin that increased to 5.47% and 6.11% for the six months ended September 30, 2021 and for Fiscal 2021, respectively, as compared to 3.73% and 3.13% for Fiscal 2020 and Fiscal 2019, respectively; (iii) our Return on Equity Ratio and Return on Capital Employed, both of which have also improved for the six months ended September 30, 2021 and Fiscal 2021 as compared to Fiscal 2020 and Fiscal 2019. As of September 30, 2021, March 31, 2021, 2020 and 2019, our Net Worth was ₹2,085.49 million, ₹1,817.75 million, ₹1,691.25 million and ₹1,879.64 million, respectively.

Set forth below is certain of our key financial information on a consolidated basis for the periods indicated.

(₹ in millions except percentages and ratios)

Particulars	As of, or for the six months ended September 30, 2021	As of, or for the year ended March 31,		
		2021	2020	2019
Gross revenue from operations	14,128.42	19,561.04	22,186.14	28,265.18
EBITDA	776.52	1,200.63	831.95	886.27

Particulars	As of, or for the six months ended September 30, 2021	As of, or for the year ended March 31,		
		2021	2020	2019
EBITDA Margin	5.47%	6.11%	3.73%	3.13%
Restated Profit/(Loss) for the period / year	279.47	111.48	(289.39)	(244.28)
Profit after tax margin (Net Profit Ratio)	1.98%	0.57%	(1.30)%	(0.86)%
Operating cash flows before working capital changes	729.98	1,164.40	805.14	934.81
Return on Capital Employed (ROCE)*	6.51%	8.59%	1.07%	3.19%
Return on Equity Ratio (ROE)*	13.35%	6.11%	(17.03)%	(12.93)%
Net Debt / EBITDA Ratio*	4.36	2.54	3.90	4.99

\*Amounts for the six months ended September 30, 2021 are not annualised

For information about non-GAAP financial measures as set forth in the table above, see “*Management’s Discussion and Analysis of Financial Position and Results of Operations – Key Performance Indicators and Non-GAAP Financial Measures*” on page 289.

### ***Experienced Promoter and professional management team with technical expertise***

The experience and diversity of our directors, management team and our Promoter have enabled our Company to be recognized as a customer centric, process driven organization with leading positions each of our OEM partners. Our Promoter and Chairman, Sanjay Karsandas Thakker, laid the foundation for our Company’s business in 1998 by launching our first dealership for Honda in Ahmedabad. Our Promoter built our business by focusing on developing a strong team of dedicated and qualified professionals to lead our Company to its industry leadership positions with our OEM partners. Mr. Thakker is supported by a team of experienced directors including Paras Somani, Executive Whole-Time Director, Aryaman Sanjay Thakker, Executive Director, and Mr. Akshay Tanna, a nominee Director of TPG. The majority of our management team have spent more than 10 years with our Company and bring capabilities to enable us to understand and anticipate automotive market trends, manage our business operations and growth, leverage our OEM relationships and respond to changes in consumer preferences in a rapidly changing environment. We will continue to leverage on the experience of our management team and their understanding of the Indian automotive industry in order to take advantage of current and future market opportunities. For more information, see the sections entitled “*Our Promoter and Promoter Group*” and “*Our Management*” beginning on pages 196 and 178, respectively.

### **Our Strategies**

Our key business strategies are set forth below.

#### ***Continue expansion focusing on high growth segments and brands***

We intend to focus on expanding our business in high growth segments like premium and luxury passenger vehicles including UVs as well as electric vehicles. We aim to leverage our relationships with the OEMs to expand geographically to achieve economies of scale We will also use our local knowledge of customer preferences to choose the markets we will enter and the best OEM with which to partner.

CRISIL Research expects overall passenger vehicles sales (mass market and premium market) to grow at a CAGR of 8-10% from Fiscal 2021 to Fiscal 2026, and reach approximately 4.2 million units by Fiscal 2026. Further, CRISIL Research expects the premium segment to grow at a CAGR of 10-12% CAGR from Fiscal 2021 to Fiscal 2026, while the luxury segment is expected to grow at a CAGR of 20-22% during the same period. (Source: *CRISIL Report, December 2021*). We intend to capitalize on this expected growth in demand for automobiles in India in general, and premium and luxury cars in particular, by increasing sales of our passenger vehicles at each of our sales outlets through our marketing programs and business processes as well as capital investments designed to support our growth targets. In addition, we will expand our business through strategic acquisitions (as discussed below).

Our business processes include monitoring and adapting to trends in customer preferences by managing our inventory and diversifying our portfolio. For example, in anticipation of the growth of the SUV market in India, we invested heavily in developing a strong market position with Jeep as they set up their operations in India. Similarly, we invested in Renault which is known for its strong product lines in SUVs and affordable electric vehicles. Further, we intend to continue to focus on improving our business processes including leveraging technology and digitalization. We expanded our outlets from 42 in Fiscal 2015 to 112\* as at September 30, 2021. This track record of expansion experience gives us confidence

in our ability to continue our expansion successfully. We also intend to continue to strategically diversify our portfolio, and will thus, continue to evaluate prospects of introducing additional brands to our existing portfolio to meet changing customer preferences, particularly in premium and luxury cars, UVs and electric vehicle companies planning to enter the Indian market.

\*includes acquisition of 4 after sales service and spares outlets pursuant to acquisition of Shaman Wheels Private Limited w.e.f. October 1, 2021.

### ***Expand our after-sales service business***

Our strategy is to expand our after-sales service offering in order to cater to additional customers and further enhance our higher-margin service and repair revenues. In that regard, we will continue to explore with our OEM dealership partners the possibility of adding service workshops and additional authorized service centers in the markets in which we operate. We will also continue to leverage the linkages between our sales outlets and service centers to retain customers who have purchased new and pre-owned vehicles from us as continuing clients of our service departments. To this end, our sales team is focused on offering extended warranties to ensure our customer retention beyond the term of normal OEM warranties.

To improve our service operations and profitability we are focusing on following aspects of our after sales business:

*Service initiation* – We have focused on service initiation to improve our service load. We are using proprietary software for better data management. We also are using technology to improve our customer care and call center activities. We are centralizing operations for cost control and efficiency. During the six months ended September 30, 2021 and Fiscal 2021, Fiscal 2020 and Fiscal 2019, we serviced 127,337, 213,755, 280,952 and 261,670 passenger vehicles, respectively, and 5,343, 7,713, 10,088 and 10,236 commercial vehicles, respectively.

*Improve revenue per car serviced* – We are focusing on increasing our service offerings and value for money service products. This has resulted in growth in our average revenue per vehicle serviced. In the six months ended September 30, 2021 and Fiscal 2021, Fiscal 2020 and Fiscal 2019, we earned an average of ₹18,316, ₹19,098, ₹16,515 and ₹16,926 for each vehicle serviced.

*Increase body paint (accident related) jobs* – We are looking to increase our body paint (accident related) service jobs. We have state of the art body shops and are using technology to offer quick repairs to small dents, body alignment jobs and structural jobs. We also look to convert cars that turn up for normal service to body shop repairs by offering quick service and value for money offers. We conduct skill contests for body paint technicians to encourage them to improve their skills. These initiatives have helped us increase the number of body paint repair orders.

*Centralized purchases* – We have centralized purchase for consumables which helps us take advantage of our scale of operations by negotiating attractive prices.

*Sharing locations and non-technical staff* – To reduce our overheads and staffing costs, we look to share back-office functions among our after-sales service and spare parts units including administration, human resources, accounts, security and housekeeping. We are also looking to combine businesses where practical to reduce our lease expenses. For example, at Thane and Ludhiana, we operate two OEM workshops in the same structure and we will have a new combined Mercedes-Benz and Honda showroom in the same structure within the first quarter of 2022.

Further, we will continue to invest in the sophisticated equipment and specially trained technicians to service increasingly complex vehicles. In that regard, we will continue to enhance our training of our mechanics and technicians and will continue to invest in diagnostic and repair equipment recommended by the OEMs with which we partner.

*Addition of capacity* – We have acquired co-dealers workshop operations and, as a part of this strategy, we have recently acquired 4 workshops of Mercedes from our co-dealer Shaman in Mumbai.

*Technological integration* – In addition, we have started integrating the technology from Pitstop into our operations to ensure fast and efficient responses to our after-sales service customers. For example, we aim to use this technology to improve efficiency and customer convenience in respect of:

- vehicle pickup and drop-off, wherein customer details and vehicle details are all available in real time with the customer by phone;
- calling and confirmation of service appointments through the online and mobile applications;
- confirmation of service estimates through the online and mobile applications; and
- selling value added services and additional essential jobs not part of original service requests through direct marketing

through our online service portal and mobile applications.

Further, we have entered into a spare parts dealership agreement with Mercedes-Benz, and we will be engaged in the business of sale of genuine parts in aftermarket in India. We intend to cater to retailers, independent workshops, authorized service centers and vehicle dealers.

### ***Build our pre-owned passenger vehicle business leveraging our experience, technology and network***

We buy and sell pre-owned passenger vehicles at each of our dealerships and our strategy is to expand this business. The sale of pre-owned cars facilitates trade-ins by customers and, thereby, assists sales of new vehicles. In addition, we look to capture the expected growth in this segment. CRISIL Research expects a healthy revival in the pre-owned passenger vehicle (mass and premium segments) market, which it expects to grow at a CAGR of 12% to 14% between Fiscal 2021 and Fiscal 2026 to 6.8-7.3 million vehicles. (Source: CRISIL Report, December 2021). Increased need for personal mobility, rising aspirations of customers, growing disposable income, lowering replacement cycles and increasing financial penetration will drive the growth in the pre-owned passenger vehicle segment. (Source: CRISIL Report, December 2021). Further, according to the CRISIL Report, the ratio of pre-owned PV to new PV sales in India currently stood at 1.3-1.5, while the ratio stood at 1.9 for the United States and Germany, 2.7 for France and 3.5 for the United Kingdom. CRISIL Research expects that India has a lot of growth potential in the pre-owned PV market, particularly as the segment gets more organised over time. CRISIL Research expects the ratio of pre-owned PV sales to new PV sales in India to reach 1.6-1.8 by Fiscal 2026. Hence, as this gap between India and the more developed economies in the ratio of pre-owned PVs to new PVs starts to narrow, we believe that there is significant opportunity to capture market share in the pre-owned passenger vehicle market in India.

According to CRISIL Research, in Fiscal 2021, approximately 20-22% of pre-owned passenger vehicles were sold by organized dealers (namely dealers with sales showroom and workshops) in India. This suggests an opportunity for our business, and we aim to leverage our new vehicle business and technology platform to provide a superior service to our customers including:

- offering pre-owned vehicles across our attractive, modern showrooms and sales outlets in 61 locations across eight states as well as our online channels
- providing transparent evaluation process to ensure consistency in quality and pricing of pre-owned vehicles;
- ensuring our pre-owned vehicles have an accurate service and accident history available for inspection by our customers; and
- offering financing and insurance products to our pre-owned vehicles customers.

We have implemented a digital SaaS platform developed by Sheerdrive, which enables digital evaluation and real-time used car pricing. The use of technology in our pre-owned vehicle acquisition and sales processes will improve our efficiencies and allow us to replicate our success across brands and geographies.

In addition, to improve customer confidence in our pre-owned vehicle inventory, we intend to offer pre-owned car certification programs. We will offer these certifications through our OEMs and our dealerships, whereby customers will be offered warranties on pre-owned cars similar to those offered to customers purchasing new vehicles.

### ***Continue to invest in technology and digitalizing sales and service channels***

Our IT systems are vital to our business, and we have our own in-house technology team, which consisted of 13 employees focused on applications and 19 employees focused on IT infrastructure as of September 30, 2021. We intend to continue to invest in our IT systems to enhance process efficiencies and to support our sales, inventory control, after-sales service, financial control and customer interaction. For example, we have our own enterprise resource planning (“ERP”) solution called Landmark Intelligence System which provides core and support functions to our HR, sales and after-sales service businesses. Further, we have a central purchase management system to control our inventory of cars, accessories and spare parts. We also have our own in-house customer relationship management (“CRM”) solutions, which are used for our presales and service customer interactions.

Building our digital footprint is a strategic priority. We aim to be a leading omnichannel premium automotive retail business through the use of technology, which we believe will help us scale more quickly and efficiently. We look to engage with our customers through their preferred mode of customer service experience. As such, we look to expand our customer engagement by continuing to invest in our online presence to drive lead creation in both new and used cars and to enhance our customer’s experience when booking after-sales service. We launched a chatbot on a leading instant messaging application to resolve customer queries. We enabled our chatbot in October 2021 to allow our customers to

book after-sales service appointments. Our goal is to have at least 15% of our service bookings made online or through our chatbot by the end of Fiscal 2022.

To strengthen our in-house technology capabilities, our IT and digital initiatives include:

- We are developing analytical models to analyze historical customer data to help provide insights on customer behaviour on our product offerings and cross-sell opportunities as well as to increase customer retention.
- We intend to launch a loyalty program which will run through all our brands and locations. Customers will be able to earn rewards for every transaction.
- We are developing a business intelligence reporting engine with the help of data analytics to assist our leadership team visualize and improve our customers’ experiences within our online systems.
- We are upgrading our internal sales booking systems across dealerships to support our new technologies.
- We are upgrading the functionalities of our in-house automated dialler system to increase the efficiency of our call centers.

We intend to continue to invest in companies focused on innovative technology or platforms in the automotive retail and after-sales service segments. Our recent investments in Pitstop and Sheerdrive are examples of the investments in start-up companies that we intend to continue to explore. These investments allow us to keep abreast of the technological developments in the passenger vehicle and after-sales service market in India and also allow us to adopt some of their innovative technology and services into our customer offerings. We realize that technology could disrupt pure “brick and mortar” dealerships and, hence, we want to stay at the forefront of new developments and technology to keep our business both relevant and growing.

**Continue strategic acquisitions to expand geographic reach in premium and luxury brands**

We will continue to seek to acquire dealerships to expand our geographic reach in premium and luxury automotive brands which may or may not be part of our existing portfolio. In particular, we are looking to expand our dealership network in fast growing demographic areas with a growing upper-middle class to which we can market our premium and luxury brands. We are focused on identifying dealership acquisition targets that will not only benefit from our management expertise, strong OEM relations and the scale of our operations, but also provide us with a competitive advantage in terms of operating independently in an area which leads to improved margin retention in sales as well as improved customer retention.

The following diagram highlights how our business has grown through strategic acquisitions during the periods indicated.

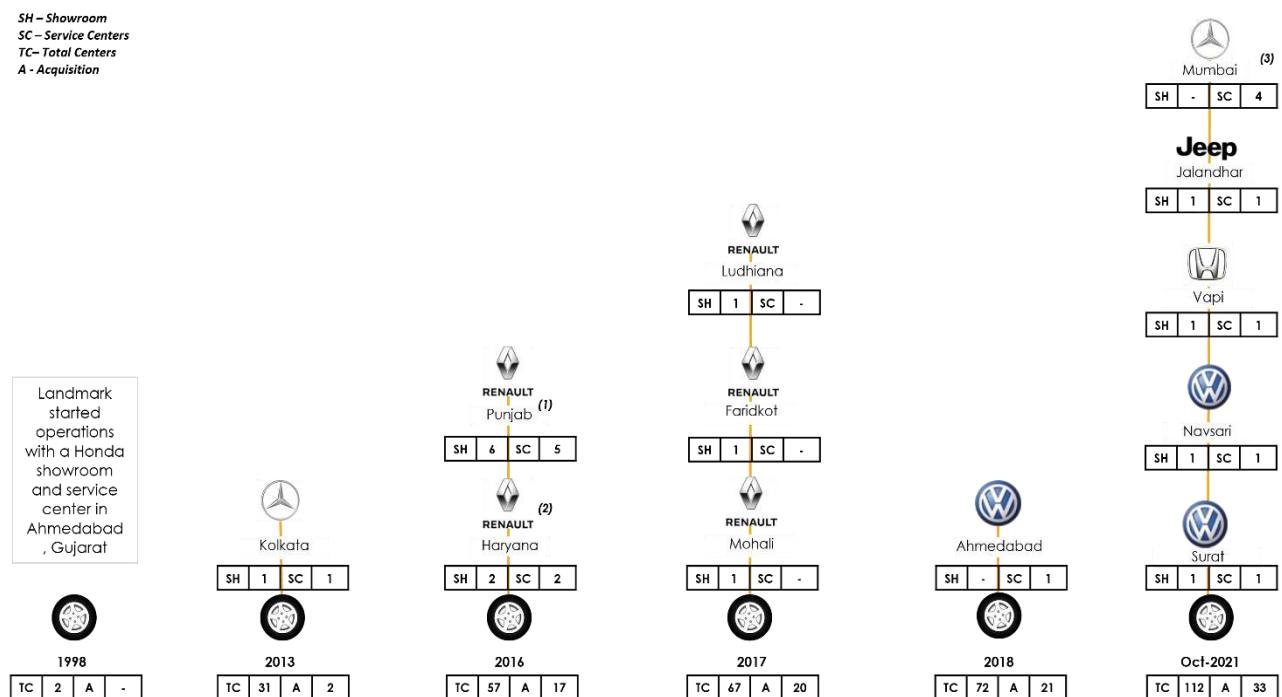



## OUR BUSINESS OPERATIONS

### Corporate Structure

Landmark Cars Limited is the parent holding company and is an authorized dealer for Mercedes-Benz. Landmark Cars Limited owns 100% of the share capital of our subsidiaries Landmark Automobiles Private Limited (holding our Honda dealership), Benchmark Motors Private Limited (holding our Renault dealership), Landmark Lifestyle Cars Private Limited (holding our Jeep dealership), Automark Motors Private Limited (holding our Volkswagen dealership), Landmark Commercial Vehicles Private Limited (holding our Ashok Leyland dealership) and Watermark Cars Private Limited (holding our accessories business and shared service centers); and 83% of the share capital of our subsidiary Landmark Cars East Private Limited (holding our Mercedes-Benz Kolkata dealership). The following chart shows our corporate structure as of September 30, 2021.

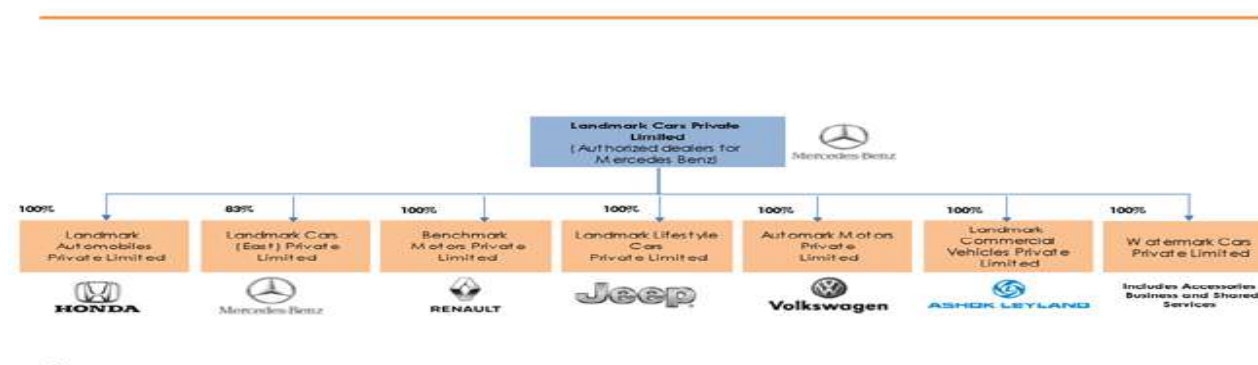

We are comprised of the following businesses: (i) new vehicle sales, (ii) pre-owned passenger vehicle sales, (iii) after-sales service and spares (including the sale of spare parts, lubricants, accessories and other product) and (iv) the facilitation of sale of third party financial and insurance products.

### Our Vehicle Dealerships

We operate passenger vehicle dealerships of Mercedes-Benz, Honda, Jeep, Volkswagen and Renault and a commercial vehicle dealership for Ashok Leyland. As of September 30, 2021, our network included 112\* outlets for passenger vehicles, comprised of 61 sales outlets and 51\* after-sales service and spares outlets. Our passenger vehicle dealership network is spread across 31 cities in 8 states and union territories including Maharashtra, Uttar Pradesh, Gujarat, Haryana, Madhya Pradesh, Punjab, West Bengal and the National Capital Territory of Delhi. We have also entered into a letter of intent dated November 30, 2021 with the automaker BYD for our Company to be their dealer in the National Capital Region (Delhi) and Mumbai in respect of their electric passenger vehicles.

The following table sets forth our outlets by OEM and by type as of September 30, 2021.

OEM/Brand	Sales Outlets	Service and Spares Outlets	Total Outlets
Mercedes-Benz	8	13*	21
Honda	10	9	19
Jeep	9	7	16
Volkswagen	9	8	17
Renault	23	12	35
Ashok Leyland	2	2	4
<b>Total</b>	<b>61</b>	<b>51</b>	<b>112</b>

\*includes acquisition of 4 after sales service and spares outlets pursuant to acquisition of Shaman Wheels Private Limited w.e.f. October 1, 2021.

The following map shows the location of our sales outlets/service and spare parts outlets by state or union territory.

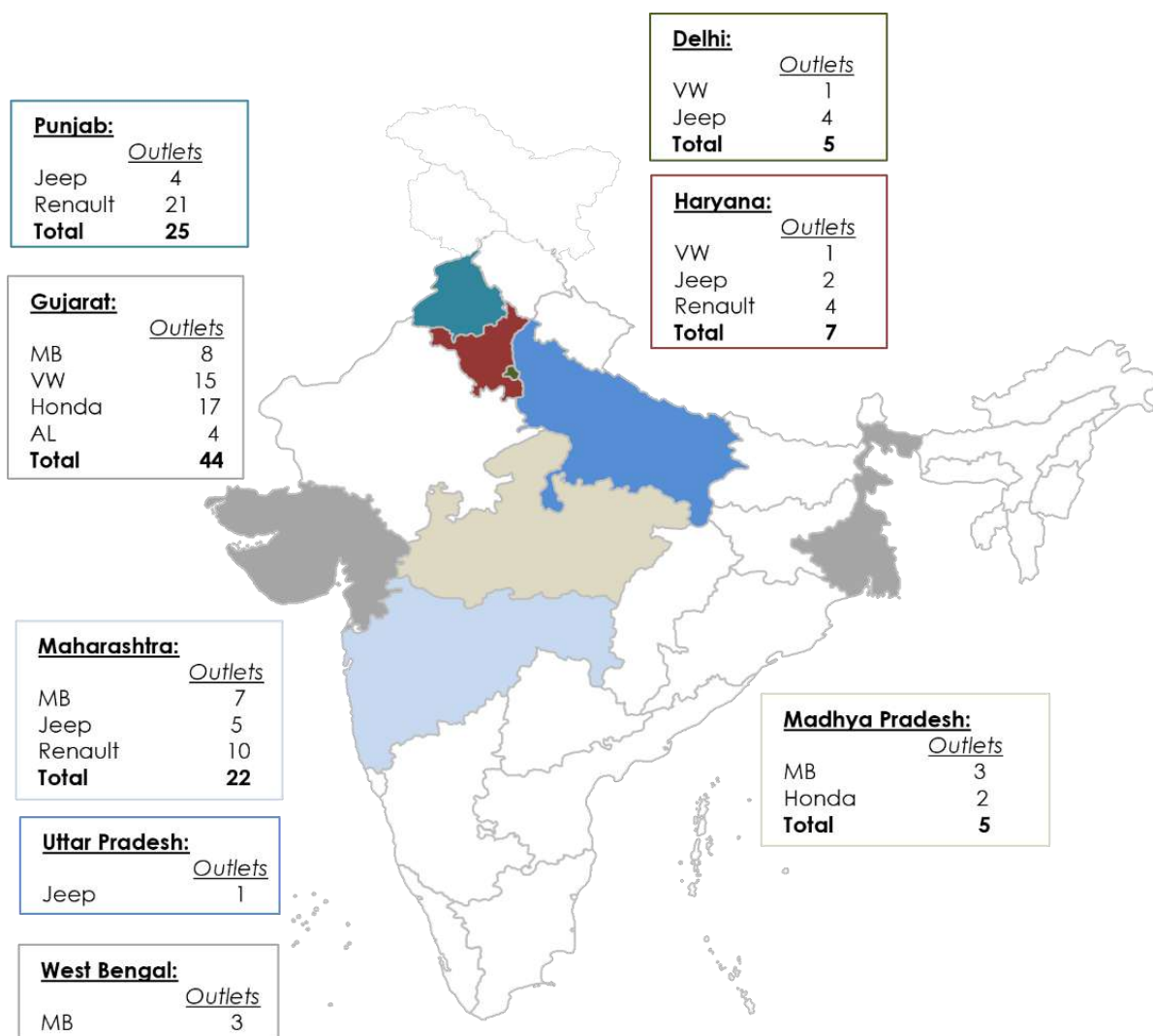

### New Vehicle Sales

Our dealerships offer a wide range of new passenger vehicles, from economy to luxury, as well as commercial vehicles. The table below shows the number of vehicles sold by each OEM or brand during the six months ended September 30, 2021 and Fiscal 2021, Fiscal 2020 and Fiscal 2019.

OEM/Brand	Half Year Fiscal 2022	Fiscal 2021	Fiscal 2020	Fiscal 2019
	<i>(number of new passenger vehicles sold)</i>			
Mercedes-Benz	921	1,133	1,780	2,264
Honda	2,414	4,500	5,801	8,691
Jeep	1,473	1,311	2,047	3,745
Volkswagen	673	1,196	1,647	2,113
Renault	2,172	4,261	4,458	3,594
Ashok Leyland	642	881	723	1,190
Former OEM partner *	-	-	274	521
<b>Total</b>	<b>8,295</b>	<b>13,282</b>	<b>16,730</b>	<b>22,118</b>

\* Sales of vehicles of former OEM partner were discontinued prior to Fiscal 2021.

Since October 1, 2021, our Mercedes-Benz dealerships operate on agency model of business as described below under “– Mercedes-Benz Dealerships”. Our other dealerships operate on a traditional purchase and sale model. Accordingly, for our dealerships (other than with respect to Mercedes-Benz), we purchase our new vehicle inventory directly from the OEMs, and we place orders on a periodic basis based on our internal assessment of customer demand as well as customer specific orders. For our inventory, the OEMs generally allocate new vehicles to us based on availability, monthly sales levels, market area demand and our order forecast. Accordingly, we rely on the OEMs to provide us with vehicles that

meet the consumer demand at our dealership locations, in appropriate quantities and prices. However, if certain models of vehicles, or vehicles with certain option configurations are in short supply, we attempt to exchange vehicles among our own outlets to accommodate customer demand and to balance inventory. New vehicles and accessories are retailed by us at prices decided by us provided that the prices are not above the maximum sale price issued to us by the OEM. We also receive monetary incentives from the OEMs for meeting certain targets they set for overall sales and for the sale of specific models of vehicles.

#### After Sales Service and Spares

Our dealerships also provide comprehensive after-sales service on vehicles manufactured by the respective OEM including the sale of spare parts, lubricants, accessories and other products.

The table below shows the number of vehicles serviced by OEM /brand during the six months ended September 30, 2021 and Fiscal 2021, Fiscal 2020 and Fiscal 2019.

OEM/Brand	Half Year Fiscal 2022	Fiscal 2021	Fiscal 2020	Fiscal 2019
	<i>(number of passenger vehicles serviced)</i>			
Mercedes-Benz	11,676	23,670	27,050	25,317
Honda	59,230	86,212	109,654	109,545
Jeep	16,782	24,689	29,767	22,194
Volkswagen	18,939	38,580	54,556	58,192
Renault	20,710	39,595	49,625	35,800
Ashok Leyland	5,343	7,713	10,088	10,236
Former OEM partner*	-	1,009	10,300	10,622
<b>Total</b>	<b>132,680</b>	<b>221,468</b>	<b>291,040</b>	<b>271,906</b>

\* After sales service of vehicles of former OEM partner was discontinued in Fiscal 2021

The following table summarizes of the manufacturer warranties by OEM and extended warranty period offered.

Brand	Manufacturer Warranty (SW) & Extended Warranty Period (EW)
MERCEDES-BENZ	3 Years – Unlimited Kms SW +3 YEARS EW UNLIMITED KM
JEEP	3 Years / 100,000 Kms SW +2 YEARS AND 150,000KM (EW)
RENAULT	2 Years / 50,000 Kms SW + 1 YEARS 10,00KM, 2 YEARS 30,000KM AND 3 YEARS 50,000KM (EW) options
VW	4 Years / 150,000 kms SW + 1 YEAR 100,000KM AND 2 YEARS 150,000KM (EW)
HONDA	3 Years / 100,000 Kms SW + 1 YEAR 8,000 KM AND 2 YEARS UNLIMITED KM (EW)

#### Mercedes-Benz Dealership

We opened our first Mercedes outlet in Gujarat in Fiscal 2009 and have expanded our presence to include 21 outlets in eight cities in Gujarat, Maharashtra, Madhya Pradesh and West Bengal, as of September 30, 2021. We were the number one dealer in India for Mercedes-Benz in terms of wholesale sales for Fiscal 2021, accounting for 13.41% of the Mercedes-Benz domestic sales in Fiscal 2021. (Source: CRISIL Report, December 2021). Our Mercedes-Benz dealerships are operated by us under the “Landmark” and “Benchmark Interkrafts” brands.

We have Mercedes-Benz sales outlets in Ahmedabad, Bhopal, Indore, Kolkata, Mumbai, Rajkot, Surat and Vadodara. The map below sets out details of our Mercedes-Benz showrooms and sales outlets (“SH”) and service centers (“SC”) as of September 30, 2021 (including the acquisition of 4 after sales service and spares outlets pursuant to acquisition of Shaman Wheels Private Limited w.e.f. October 1, 2021).

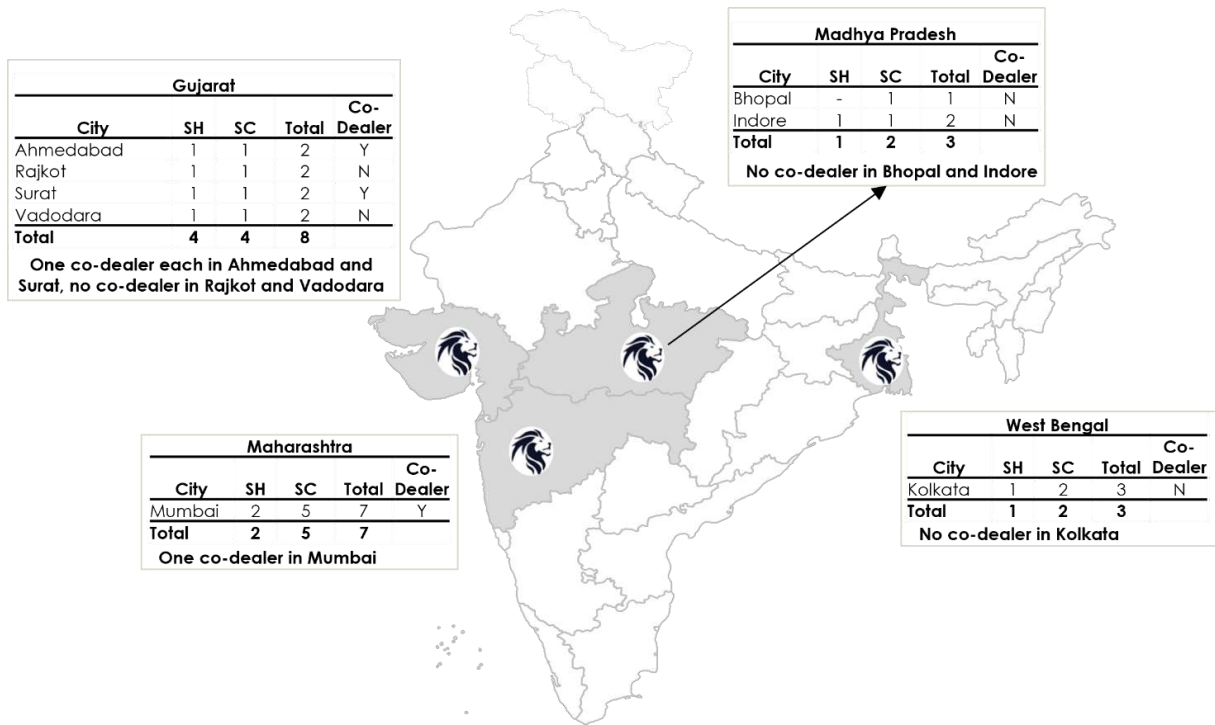

**Notes:**

Co-dealers are competing dealerships not operated by our Company

**Retail of new passenger vehicles**

Through our Mercedes-Benz dealerships, we offered the following sedan, saloon and SUV models, as of September 30, 2021:

Sedan and Saloon	SUV
<ul style="list-style-type: none"> <li>A Class</li> <li>C Class</li> <li>E Class</li> <li>Mercedes-Maybach S-Class</li> <li>S Class</li> </ul>	<ul style="list-style-type: none"> <li>GLA</li> <li>GLC</li> <li>GLE</li> <li>G Class</li> <li>GLS / GLS -Maybach</li> </ul>

In addition, we offer Mercedes-AMG models, which are high performance sports cars, V Class multi-purpose vehicles, specialty cars and Mercedes line of electric EQ vehicles.



The following table sets forth our sales volumes and sales revenue from Mercedes-Benz passenger vehicles and such

sales volumes as percentage of our total passenger vehicles sold and such sales revenue as a percentage of our consolidated passenger vehicle sales revenue, for the periods indicated.

(in ₹ millions except percentages and number of cars)

Mercedes-Benz	Six Months Ended September 30, 2021		Fiscal 2021		Fiscal 2020		Fiscal 2019	
	Sales	% of total	Sales	% of total	Sales	% of total	Sales	% of total
Volume of vehicles <sup>(1)</sup>	921	11.10%	1,133	8.53%	1,780	10.64%	2,264	10.24%
Revenue <sup>(2)</sup>	4,076.77	35.91%	4,752.73	32.88%	5,791.68	34.76%	7,122.83	31.21%

Notes:

(1) Volume is the number of Mercedes-Benz passenger vehicles sold and the volume as a percentage of volume of passenger vehicles sold of all OEMs by the Company.

(2) Sales are gross sales on a consolidated basis of new Mercedes-Benz passenger vehicles and such sales as percentage of consolidated passenger vehicle sales revenue.

### **Dealership Agreements and Agency Agreements**

We are an authorized dealer of Mercedes-Benz India Private Limited (“Mercedes-Benz”) and, through September 30, 2021 purchased our new vehicle inventory directly from Mercedes-Benz under dealership agreements. Beginning October 1, 2021, Mercedes-Benz moved to an agency model of business whereby all car sales are to be made directly among the customers and Mercedes-Benz and all vehicles will be sold to customers at the same prices across India. Under this model, we no longer purchase cars from Mercedes-Benz and resell them to the customers and hence, we will have no inventory of cars and customers will place orders through us to Mercedes-Benz on which we will earn commissions. The cars will be manufactured to the customers specifications and dispatched to our dealerships for delivery to the customer.

We have entered into agency agreements with Mercedes-Benz, effective as of October 1, 2021, under which we are an authorized agent of Mercedes-Benz on a non-exclusive basis, in Gujarat, Maharashtra, Madhya Pradesh and West Bengal. The agreements are valid for a term of three years. Our agency agreements require us to comply with the operational procedures and standards for sales and after-sales service of Mercedes-Benz, our systems should be acceptable to Mercedes-Benz, our staff and technicians are trained as per Mercedes-Benz’s requirements and we also comply with restrictions relating to inventory levels, signage, promotion and advertising, among other things. For further information on how our agency and dealer agreements, restrict our operations, see “*Risk Factors – We are subject to the significant influence of, and restrictions imposed by OEMs pursuant to the terms of our dealership or agency agreements that may adversely impact our business, results of operations, financial condition and prospects, including our ability to expand into new territories and acquire additional dealerships.*” on page 28.

### **After-sales service**

We have authorized Mercedes-Benz service centers and offer after-sales service as well as the sale of spares, lubricants, accessories and other products. As of September 30, 2021, we had 13\* Mercedes-Benz after-sales service and spares outlets. In the six months ended September 30, 2021, Fiscal 2021, Fiscal 2020 and Fiscal 2019, we serviced 11,676, 23,670, 27,050 and 25,317 Mercedes-Benz vehicles.

\* includes acquisition of 4 after sales service and spares outlets pursuant to acquisition of Shaman Wheels Private Limited w.e.f. October 1, 2021.

Our maintenance and repair services include warranty work, customer paid work, running repair and collision repair services. We also sell Mercedes-Benz spare parts in addition to our after-sales service. New Mercedes-Benz passenger vehicles sold are covered under manufacturer warranty for a period of three years (unlimited kms) from first registration plus up to an additional 3 years (unlimited kms) Star Care warranty. We also offer an extended warranty to help us retain our customers beyond the standard warranty period. We provide a 24-hour on road assistance in case of emergencies for three years from the first registration and 24-hour service for quick response in the case of break downs. In instances where services are covered under vehicle insurance policies, we assist customers in completing the relevant formalities to make the necessary claims under the insurance policies.

With effect from October 1, 2021, we have acquired 4 workshops of Mercedes-Benz from our co-dealer Shaman Wheels Private Limited in Mumbai, to enhance our service coverage of the Greater Mumbai area.

### **Honda Dealership**

We opened our first Honda outlet in Ahmedabad in 1998 and have expanded our presence to include 19 outlets in eight cities in Gujarat and Madhya Pradesh, as of September 30, 2021. We were the largest dealership partner for Honda in

terms of sales by volume in India accounting for over 5.48% of Honda passenger vehicles sold in Fiscal 2021. (Source: CRISIL Report, December 2021). Our Honda dealership is operated by us under the “Landmark Honda” brand.

We have Honda sales outlets in Ahmedabad, Indore, Jamnagar, Mehsana, Navsari, Rajkot, Surat and Vapi. The map below sets out details of our Honda showrooms and sales outlets (“SH”) and service centers (“SC”) as of September 30, 2021.

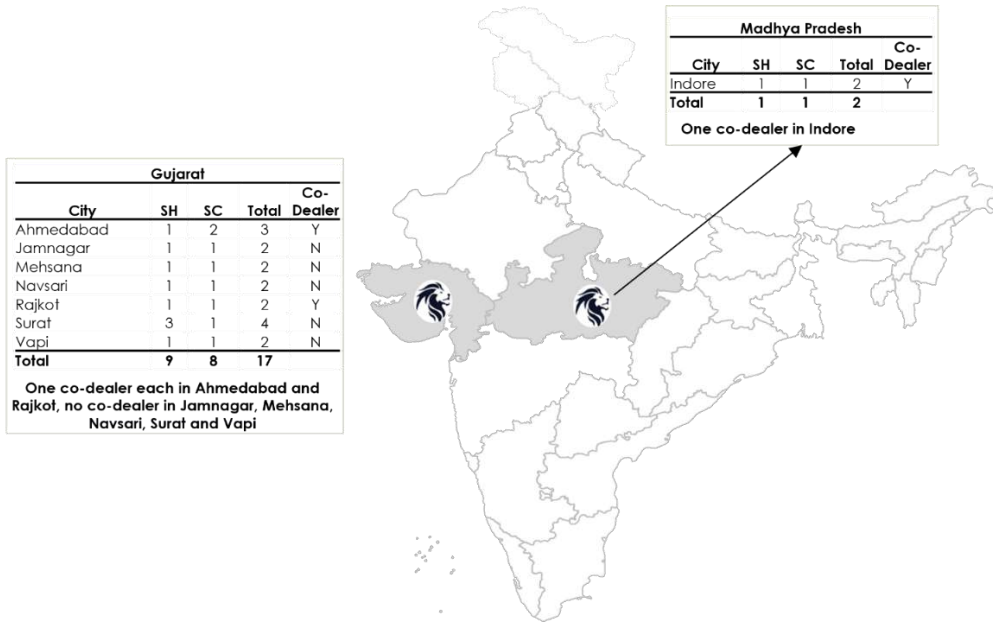

**Notes:**

Co-dealers are competing dealerships not operated by our Company

**Retail of new passenger vehicles**

Through our Honda dealership, as of September 30, 2021, we offered the following passenger vehicle models:

- City, a sedan;
- WR-V, a small SUV;
- Jazz, a hatchback; and
- Amaze, a compact sedan.





In addition, we expect that Honda will be launching new SUVs in the Indian market in the near future.

The following table sets forth our sales volumes and sales revenue from Honda passenger vehicles and such sales volumes as percentage of our total passenger vehicles sold and such sales revenue as a percentage of our consolidated passenger vehicle sales revenue, for the periods indicated.

(₹ in millions except percentages and number of cars)

Honda	Six Months Ended September 30, 2021		Fiscal 2021		Fiscal 2020		Fiscal 2019	
	Sales	% of total	Sales	% of total	Sales	% of total	Sales	% of total
Volume of vehicles <sup>(1)</sup>	2,414	29.10%	4,500	33.88%	5,801	34.67%	8,691	39.29%
Revenue <sup>(2)</sup>	1,659.15	14.61%	2,994.17	20.71%	3,687.34	22.13%	5,551.17	24.33%

Notes:

- (1) Volume is the number of Honda passenger vehicles sold and the volume as a percentage of volume of passenger vehicles sold of all OEMs by the Company.
- (2) Sales are gross sales on a consolidated basis of new Honda passenger vehicles and such sales as percentage of our consolidated passenger vehicle sales revenue.

### Dealership Agreements

We have entered into a dealership agreement with Honda Cars India Limited (“Honda”) under which we are an authorized dealer to sell and service passenger vehicles supplied by Honda, on a non-exclusive basis, in Gujarat and Madhya Pradesh. The agreement is valid for a term of one year and is renewable with the mutual consent of both parties. Currently, the agreement has been renewed until March 31, 2022. The dealership agreement covers business processes, operational standards and procedures with which we are required to comply. Further, pursuant to the terms of the agreements, we are subject to restrictions relating to inventory levels, the sales process, marketing and branding, showroom and service facilities, signage, personnel, changes in management, audits, and monthly financial reporting, among other things. For further information on how our agency and dealer agreements, restrict our operations, see “Risk Factors – We are subject to the significant influence of, and restrictions imposed by OEMs pursuant to the terms of our dealership or agency agreements that may adversely impact our business, results of operations, financial condition and prospects, including our ability to expand into new territories and acquire additional dealerships.” on page 28.

### After-sales service

We have authorized Honda service centers and offer after-sales service as well as the sale of spares, lubricants, accessories and other products. As of September 30, 2021, we had 9 Honda after-sales service and spares outlets. In the six months ended September 30, 2021, Fiscal 2021, Fiscal 2020 and Fiscal 2019, we serviced 59,230, 86,212, 109,654 and 109,545 Honda vehicles.

Our maintenance and repair services under each of our dealerships include warranty work, customer paid work, running repair and collision repair services. New Honda passenger vehicles sold are covered under manufacturer warranty for a period of three years or 100,000 kms. We also offer an extended warranty for an additional 2 years (unlimited kms) to help us retain our customers beyond the standard warranty period. We also offer road-side assistance in case of emergencies and periodic maintenance packages. In instances where services are covered under vehicle insurance policies, we assist customers in completing the relevant formalities to make the necessary claims under the insurance policies. Many of our service stations have extended evening and weekend service hours and also offer vehicle pick-up and drop services for the convenience of our customers.

### Jeep Dealership

We opened our first Jeep outlet in Delhi in 2017 and have expanded our presence, as of September 30, 2021, to include 16 outlets in 6 cities in Maharashtra, Uttar Pradesh, Haryana, Punjab and the National Capital Territory of Delhi. The Jeep brand is now owned by Stellantis after the merger of Fiat Chrysler Automobiles with the PSA Group. We were the largest dealership partner of Jeep in terms of sales by volume in India accounting for over 20.01% of Jeep passenger vehicles sold in 2020. (Source: CRISIL Report, December 2021). Our Jeep dealership is operated by us under the “Landmark Jeep” brand.

We have Jeep sales outlets in Delhi, Gurugram, Jalandhar, Ludhiana, Mumbai and Noida. The map below sets out details of our Jeep showrooms and sales outlets (“SH”) and service centers (“SC”) as of September 30, 2021.

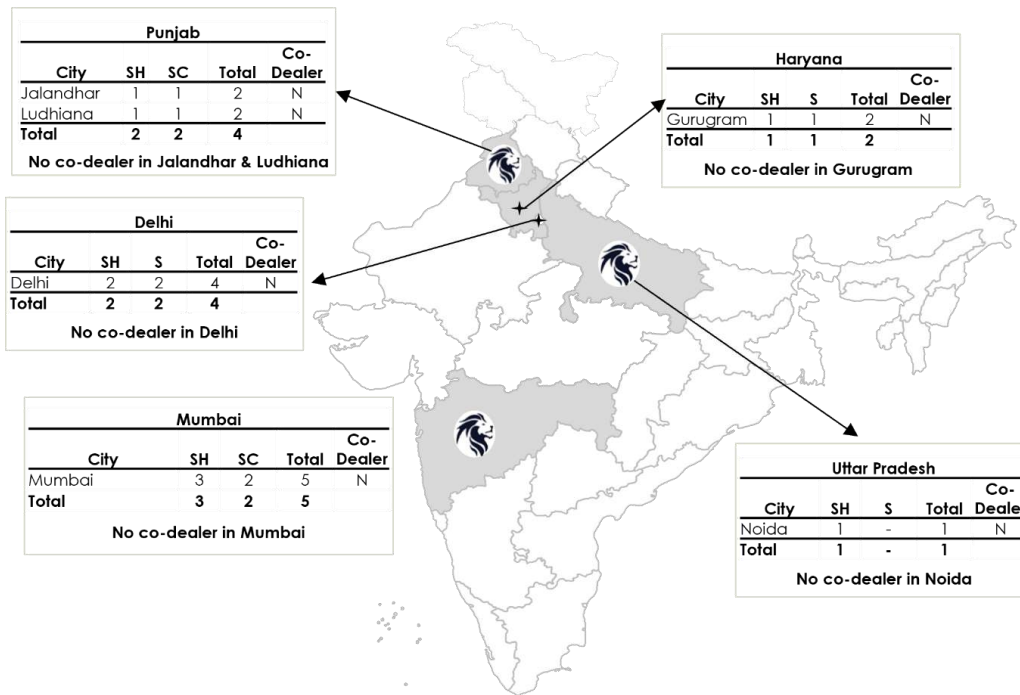

**Notes:**

Co-dealers are competing dealerships not operated by our Company

**Retail of new passenger vehicles**

Through our Jeep dealership, as of September 30, 2021, we offered Jeep brand vehicles including the Compass, a SUV, and the Wrangler, a large utility vehicle. In addition, we are exploring expanding our range of vehicles to include the full Stellantis offering.



The following table sets forth our sales volumes and sales revenue from Jeep passenger vehicles and such sales volumes as percentage of our total passenger vehicles sold and such sales revenue as a percentage of our consolidated passenger vehicle sales revenue, for the periods indicated.



(₹ in millions except percentages and number of cars)

Jeep	Six Months Ended September 30, 2021		Fiscal 2021		Fiscal 2020		Fiscal 2019	
	Sales	% of total	Sales	% of total	Sales	% of total	Sales	% of total
Volume of vehicles <sup>(1)</sup>	1,473	17.76%	1,311	9.87%	2,047	12.24%	3,745	16.93%
Revenue <sup>(2)</sup>	2,586.47	22.78%	2,044.50	14.14%	2,792.08	16.76%	4,866.45	21.33%

Notes:

- (1) Volume is the number of Jeep passenger vehicles sold and the volume as a percentage of volume of passenger vehicles sold of all OEMs by the Company.
- (2) Sales are gross sales on a consolidated basis of new Jeep passenger vehicles and such sales as percentage of our consolidated passenger vehicle sales revenue.

### Dealership Agreements

We have entered into a dealership agreement with FCA India Automobiles Limited (“FCA India”) under which we are an authorized dealer to sell and service the Jeep brand passenger vehicles supplied by FCA India in Mumbai, Delhi, Noida and Punjab. The agreement is valid for a term of three years and is renewable with the mutual consent of both parties. Currently, the agreement has been renewed until April 17, 2024. The dealership agreement covers business processes, operational standards and procedures with which we are required to comply. Further, pursuant to the terms of the agreements, we are subject to restrictions relating to inventory levels, the sales process, marketing and branding, showroom and service facilities, signage, personnel, changes in management, audits, and monthly financial reporting, among other things. For further information on how our agency and dealer agreements, restrict our operations, see “Risk Factors – We are subject to the significant influence of, and restrictions imposed by OEMs pursuant to the terms of our dealership or agency agreements that may adversely impact our business, results of operations, financial condition and prospects, including our ability to expand into new territories and acquire additional dealerships.” on page 28.

### After-sales service

We have authorized Jeep service centers and offer after-sales service as well as the sale of spares, lubricants, accessories and other products. As of September 30, 2021, we had 7 Jeep after-sales service and spares outlets. In the six months ended September 30, 2021, Fiscal 2021, Fiscal 2020 and Fiscal 2019, we serviced 16,782, 24,689, 29,767 and 22,194 Jeep vehicles.

Our maintenance and repair services under each of our dealerships include warranty work, customer paid work, running repair and collision repair services. New Jeep passenger vehicles sold are covered under manufacturer warranty up to 3 years or 100,000 kms. We also offer an extended warranty for an additional 2 years or 150,000 kms to help us retain our customers beyond the standard warranty period. We also offer roadside assistance in case of emergencies and periodic maintenance packages. In instances where services are covered under vehicle insurance policies, we assist customers in completing the relevant formalities to make the necessary claims under the insurance policies. Many of our service stations have extended evening and weekend service hours and also offer vehicle pick-up and drop services for the convenience of our customers.

### Volkswagen Dealership

We opened our first Volkswagen outlet in Ahmedabad in 2008 and have expanded our presence, as of September 30, 2021, to include 17 outlets in 8 cities in Gujarat, Haryana and the National Capital Territory of Delhi. We were the largest dealership partner for Volkswagen in terms of sales by volume in India accounting for over 5.85% of Volkswagen passenger vehicles sold in 2020. (Source: CRISIL Report, December 2021). Our Volkswagen dealership is operated by us under the “Volkswagen” brand.

We have Volkswagen sales outlets in Ahmedabad, National Capital Territory (Delhi), Navsari, Rajkot, Surat, Vadodara and Vapi. The map below sets out details of our Volkswagen showrooms and sales outlets (“SH”) and service centers (“SC”) as of September 30, 2021.

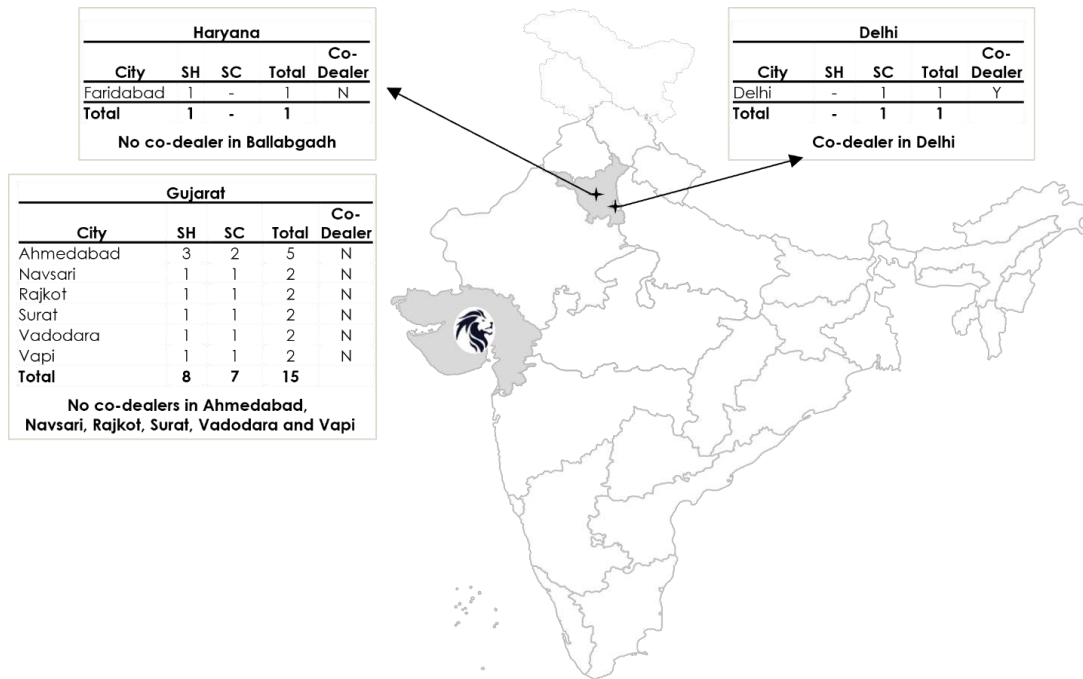

**Notes:**

Co-dealers are competing dealerships not operated by our Company

**Retail of new passenger vehicles**

Through our Volkswagen dealership, as of September 30, 2021, we offered the following passenger vehicle models:

- Taigun, a SUV;
- Polo, a hatchback;
- T-Roc, a SUV;
- Tiguan Allspace, a 7-seater SUV; and
- Vento, a sedan.



The following table sets forth our sales volumes and sales revenue from Volkswagen passenger vehicles and such sales volumes as percentage of our total passenger vehicles sold and such sales revenue as a percentage of our consolidated passenger vehicle sales revenue, for the periods indicated.

(₹ in millions except percentages and number of cars)

Volkswagen	Six Months Ended September 30, 2021		Fiscal 2021		Fiscal 2020		Fiscal 2019	
	Sales	% of total	Sales	% of total	Sales	% of total	Sales	% of total
Volume of vehicles <sup>(1)</sup>	673	8.11%	1,196	9.00%	1,647	9.84%	2,113	9.55%
Revenue <sup>(2)</sup>	531.20	4.68%	934.12	6.46%	1,155.53	6.94%	1,555.86	6.82%

Notes:

- (1) Volume is the number of Volkswagen passenger vehicles sold and the volume as a percentage of volume of passenger vehicles sold of all OEMs by the Company.
- (2) Sales are gross sales on a consolidated basis of new Volkswagen passenger vehicles and such sales as percentage of our consolidated passenger vehicle sales revenue.

### **Dealership Agreements**

We have entered into dealership agreements with Volkswagen Passenger Cars, a division of SKODA Auto Volkswagen India Private Limited (“Volkswagen”) and Automark Motors Private Limited under which we are an authorized dealer to sell and service passenger vehicles supplied by Volkswagen in Gujarat, Haryana and the National Capital Territory of Delhi on a non-exclusive basis. The agreements are valid for a term of three years. Currently, the agreement has been renewed until December 31, 2023. The dealership agreement covers business processes, operational standards and procedures with which we are required to comply. Further, pursuant to the terms of the agreements, we are subject to restrictions relating to inventory levels, the sales process, marketing and branding, showroom and service facilities, signage, personnel, changes in management, audits, and monthly financial reporting, among other things. For further information on how our agency and dealer agreements, restrict our operations, see “*Risk Factors – We are subject to the significant influence of, and restrictions imposed by OEMs pursuant to the terms of our dealership or agency agreements that may adversely impact our business, results of operations, financial condition and prospects, including our ability to expand into new territories and acquire additional dealerships.*” on page 28.

### **After-sales service**

We have authorized Volkswagen service centers and offer after-sales service as well as the sale of spares, lubricants, accessories and other products. As of September 30, 2021, we had 8 Volkswagen after-sales service and spares outlets. In the six months ended September 30, 2021, Fiscal 2021, Fiscal 2020 and Fiscal 2019, we serviced 18,939, 38,580, 54,556 and 58,192 Volkswagen vehicles.

Our maintenance and repair services under each of our dealerships include warranty work, customer paid work, running repair and collision repair services. New Volkswagen passenger vehicles sold are covered under manufacturer warranty for a period of up to 4 years or 150,000 kms We also offer extended warranties for an additional 2 years or 30,000 kms and 3 years or 50,000 kms to help us retain our customers beyond the standard warranty period. We also offer roadside assistance in case of emergencies and periodic maintenance packages. In instances where services are covered under vehicle insurance policies, we assist customers in completing the relevant formalities to make the necessary claims under the insurance policies. Many of our service stations have extended evening and weekend service hours and also offer vehicle pick-up and drop services for the convenience of our customers.

### **Renault Dealership**

We acquired our first Renault outlet in Punjab in 2016 and have expanded our presence, as of September 30, 2021, to include 35 outlets in 16 cities in Haryana, Maharashtra and Punjab. We are a dealer of Renault in greater Mumbai and the state of Punjab. We were the third largest dealership partner for Renault in terms of sales by volume in India accounting for over 4.62% of Renault passenger vehicles sold in 2020. (Source: CRISIL Report, December 2021). Our Renault dealership is operated by us under the “Renault” brand.

The map below sets out details of our Renault showrooms and sales outlets (“SH”) and service centers (“SC”) as of September 30, 2021.

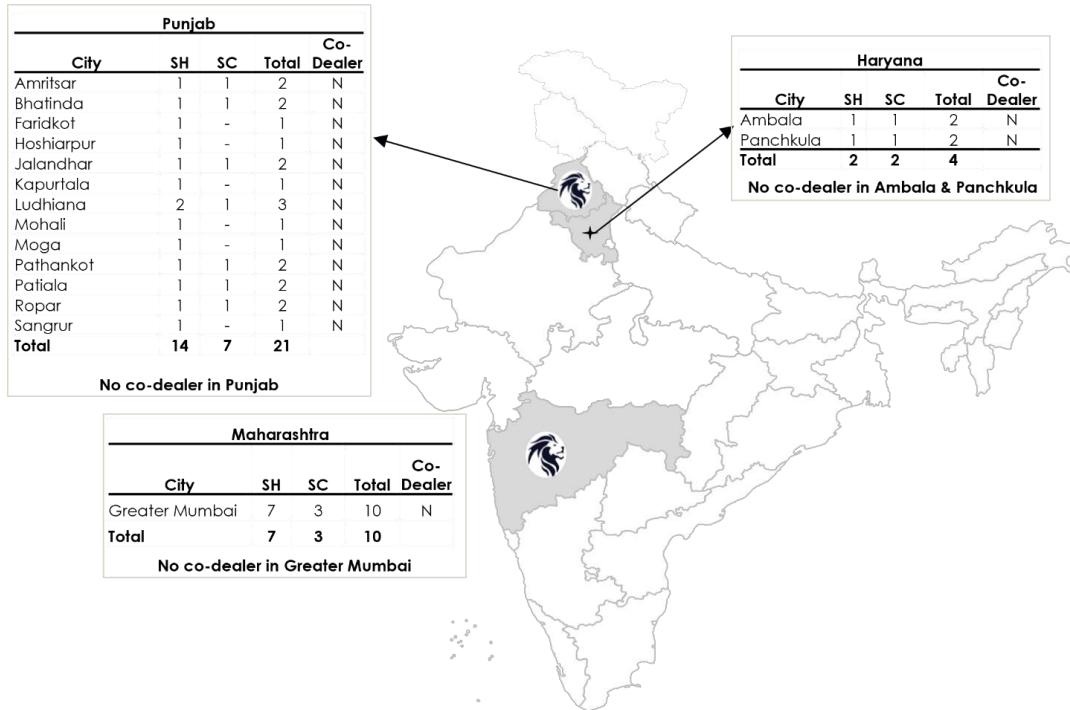

**Notes:**

Co-dealers are competing dealerships not operated by our Company

**Retail of new passenger vehicles**

Through our Renault dealership, as of September 30, 2021, we offered the following passenger vehicle models:

- Kiger; 5 seat SUV
- Duster, 5 seat SUV;
- Triber, 7 seat MUV; and
- KWID, 5 seat hatchback.



The following table sets forth our sales volumes and sales revenue from Renault passenger vehicles and such sales volumes as percentage of our total passenger vehicles sold and such sales revenue as a percentage of our consolidated passenger vehicle sales revenue, for the periods indicated.

(in ₹ millions except percentages and number of cars)

Renault	Six Months Ended September 30, 2021		Fiscal 2021		Fiscal 2020		Fiscal 2019	
	Sales	% of total	Sales	% of total	Sales	% of total	Sales	% of total
Volume of vehicles <sup>(1)</sup>	2,172	26.18%	4,261	32.08%	4,458	26.65%	3,594	16.25%
Revenue <sup>(2)</sup>	1,093.97	9.64%	1,864.02	12.89%	1,888.82	11.34%	1,387.69	6.08%

Notes:

- (1) Volume is the number of Renault passenger vehicles sold and the volume as a percentage of volume of passenger vehicles sold of all OEMs by the Company.
- (2) Sales are gross sales on a consolidated basis of new Renault passenger vehicles and such sales as percentage of our consolidated passenger vehicle sales revenue.

### **Dealership Agreements and Purchase Arrangements**

We have entered into dealership agreements with Renault India Private Limited (“Renault”) under which we are an authorized dealer to sell and service passenger vehicles supplied by Renault. In accordance with the subsequent agreement, we are Renault’s dealer in greater Mumbai, Punjab and Haryana. The dealership agreement is valid for a term of one year and is renewable with the mutual consent of both parties. Currently, the agreement has been renewed until September 30, 2022. Pursuant to the terms of the agreement, we are subject to numerous operational requirements and restrictions relating to inventory levels, working capital levels, the sales process, marketing and branding, showroom and service facilities, personnel, changes in management, and financial reporting, among other things. For further information on how our agency and dealer agreements, restrict our operations, see “*Risk Factors – We are subject to the significant influence of, and restrictions imposed by OEMs pursuant to the terms of our dealership or agency agreements that may adversely impact our business, results of operations, financial condition and prospects, including our ability to expand into new territories and acquire additional dealerships.*” on page 28.

### **After-sales service**

We have authorized Renault service centers and offer after-sales service as well as the sale of spares, lubricants, accessories and other products. As of September 30, 2021, we had 12 Renault after-sales service and spares outlets. In the six months ended September 30, 2021, Fiscal 2021, Fiscal 2020 and Fiscal 2019, we serviced 20,710, 39,595, 49,625 and 35,800 Renault vehicles.

Our maintenance and repair services under each of our dealerships include warranty work, customer paid work, running repair and collision repair services. New Renault passenger vehicles sold are covered under manufacturer warranty for a period of two years or 50,000 kms. We also offer extended warranties for an additional 1 year (or 10,000 kms), 2 years (or 30,000 kms) 3 years (or 50,000 kms) to help us retain our customers beyond the standard warranty period. We also offer roadside assistance in case of emergencies and periodic maintenance packages. In instances where services are covered under vehicle insurance policies, we assist customers in completing the relevant formalities to make the necessary claims under the insurance policies. Many of our service stations have extended evening and weekend service hours and also offer vehicle pick-up and drop services for the convenience of our customers.

### **Ashok Leyland Dealership**

We sell commercial vehicles through our dealership for Ashok Leyland Limited (“Ashok Leyland”). We opened our first Ashok Leyland sales outlet in Vadodara in 2012 and opened our second sales outlet in Ahmedabad in 2014. Our Ashok Leyland dealership is operated by us under the “*Landmark*” brand.

### **Sale of new commercial vehicles**

Through our Ashok Leyland dealership, as of September 30, 2021, we offered a range of mini-buses, trucks and light vehicles including:

#### **Buses**

- ICVs – LYNX 1511; Sunshine School Bus
- MDVs – VK -2011; TF -1812; Oyster Staff Bus

### Trucks

- Tractor trailers – UL020; U5525, U4620
- MAVs – GB 2820 6x2; M3520 8x2, GB4220- 10x2, Nr825 10x2
- Haulage trucks – EA 1920 4x2; EA1916 4x2
- Tippers – MA 1920 4x2; UE2820 6x4 RMC; ME2820T 6x4; MJ3520T 6x4; UJ3520T 8x4; UE2820T 6x4; ME2825T 6x4; MM4220T 10x4; N2825T 10x4
- ICVs – Ecomet 1215, 1415 and 1615; Boss 1215 and 1415; Guru 1215

In the six months ended September 30, 2021, Fiscal 2021, Fiscal 2020 and Fiscal 2019, we sold 642, 881, 723 and 1,190 new Ashok Leyland vehicles. In the six months ended September 30, 2021, Fiscal 2021, Fiscal 2020 and Fiscal 2019, our new commercial vehicle sales at our Ashok Leyland dealership were ₹1,405.32 million, ₹1,865.90 million, ₹1,229.74 million and ₹2,127.46 million, respectively.

### Dealership Agreements and Purchase Arrangements

We have entered into a dealership agreement with Ashok Leyland under which we are an authorized dealer to sell and service vehicles manufactured by Ashok Leyland in Vadodara and Ahmedabad on a non-exclusive basis. The agreement is valid from January 1, 2020 to March 31, 2023 and is renewable if we give Ashok Leyland notice at least three months before the expiry of the agreement to enter into a new agreement for a further period. For further information on how our agency and dealer agreements, restrict our operations, see “*Risk Factors – We are subject to the significant influence of, and restrictions imposed by OEMs pursuant to the terms of our dealership or agency agreements that may adversely impact our business, results of operations, financial condition and prospects, including our ability to expand into new territories and acquire additional dealerships.*” on page 28.

### After-sales service

We offer after-sales service at our two authorized Ashok Leyland service centers. In the six months ended September 30, 2021, Fiscal 2021, Fiscal 2020 and Fiscal 2019, we serviced 5,343, 7,713, 10,088 and 10,236 Ashok Leyland vehicles. We also sell Ashok Leyland spare parts and lubricants in addition as part of our after-sales service.

Our maintenance and repair services under each of our dealerships include warranty work, customer paid work, running repair and collision repair services. New Ashok Leyland commercial vehicles sold are covered under manufacturer warranty for a period of up to 3 years. We also offer an extended warranty of up to one year to help us retain our customers beyond the standard warranty period.

### Vehicle Finance and Insurance Sales

As a value add-on to our passenger vehicle sales, we facilitate the sale of third-party financial products including insurance policies and vehicle finance through our dealerships. Each of our dealerships offer finance and insurance to our customers. Mercedes-Benz and Renault have captive finance companies which give product offerings to the customers which are not available for competing OEMs.

We assist our customers in completing applications and other paperwork at our sales outlets and usually submit the applications on their behalf. We also look to renew policies at the time of vehicle service as well as through our call centers and help our customers with paperwork in the event of a claim. We typically receive a portion of the cost of the financing paid or sum assured by the customer for each transaction as a fee from the finance or insurance provider.

The table below sets forth our consolidated gross revenue from facilitated insurance and financial products during the six months ended September 30, 2021 and Fiscal 2021, Fiscal 2020 and Fiscal 2019 and such sales revenue as a percentage of our consolidated vehicle sales revenue, for the periods indicated.

(₹ in millions except percentages)

Particulars	Six Months Ended September 30, 2021		Fiscal 2021		Fiscal 2020		Fiscal 2019	
	Sales	% of total	Sales	% of total	Sales	% of total	Sales	% of total
Revenue from financial products	90.37	0.79%	139.48	0.94%	208.01	1.23%	262.24	1.14%

### Pre-owned Passenger Vehicle Sales

We buy and sell pre-owned passenger vehicles at each of dealerships and our strategy is to expand this business. Historically, our pre-owned vehicles business was restricted to accepting trade-ins from customers and facilitating the

sales of these vehicles through various brokers on a commission basis. We are now operating on two business models: (1) we facilitate the sale of the used vehicles back-to-back through our appointed panel of agents on a commission basis or (2) we take the vehicles on our books for sale after any needed refurbishment. We also receive an incentive from our OEMs for used vehicles traded in for new vehicles.

We have commenced using technology developed by Sheerdrive in the evaluation and pricing of used vehicles to ensure speed and accuracy. The use of technology in our pre-owned vehicle acquisition and sales processes is expected to improve our efficiencies. This will enable us to buy the vehicles in our own books and sell them through our own sales outlets without incurring any additional cost on infrastructure and manpower.

## **Sales and Marketing**

Our sales and marketing activities for our dealerships are carried out by our sales and marketing personnel at each of our dealerships, which is aligned to a central marketing team which provides support and direction. Our marketing strategy focuses on our individual businesses to capitalize on local branding, as well as corporate programs and web presence. This allows us to leverage scale and brand recognition. We align ourselves with the marketing implemented by our OEMs for their respective brands and integrate those initiatives and resources across the brands we represent. We have been increasing our sales and marketing budget to build a strong brand presence. In addition, to our individual brand marketing, we have been branding and position our Company with the “Group Landmark” brand.

Our Company has employed a combination of traditional advertising and social media marketing to reach a target audience. We regularly employ traditional advertising, which includes television advertisements, print ads, and other print media. We have advertised in a number of national newspapers. We use various local magazines and specialty magazines to reach target local audiences. For example, we advertise in trade to reach Surat based diamond merchants. Our sales force team also uses brochures and flyers to reach rural markets.

Our marketing campaigns are executed through social media platforms. Each of these platforms has different formats that serve different types of customers. We use these platforms for advertising offers, new model launches and even booking test drives. Additionally, leads are generated on a timely basis by using these platforms. Through our marketing programs we intend to increase customer engagement with our target market across other digital channels including our websites, email marketing, online advertising and search engine optimization.

We also sponsor events for promotions of our Group Landmark brand, customer engagement opportunities and/or customer databases. For example, we are the official sponsor for the Pune 7 Aces team in the Premier Badminton League and have been the luxury fleet partners for various celebrities. We also partner with various third-party brands to host customer engagement activities at our showrooms, which increases the amount of walk-ins and provides exposure to new sets of audiences. We also have promotional partners that have established, large following bases on social media. Our promotional partners either promote events or our brands with their following bases.

## **Customer Care**

Customer care managers at each of our dealerships are responsible for taking feedback from customers at various stages, right from the time of booking the vehicle up to delivery of the vehicle which is further followed up by post sales feedback. Each of our dealerships have dedicated helplines which address customer grievances. In addition, we are now using our chatbot on a leading instant messaging mobile application to resolve customers’ queries.

## **Information Technology**

Our IT systems are vital to our business, and we have our own inhouse technology team, which consisted of 13 employees focused on applications and 19 employees focused on IT infrastructure as of September 30, 2021.

We have our own ERP solution called Landmark Intelligence System which provides core and support functions to our HR, sales and after-sales service businesses. We also utilize the Tally (SAP B1 under development), to provide financial controls over different parts of our business. Further, we have a central purchase management system to control our inventory of cars, accessories and spare parts. We also have our own inhouse CRM solutions, which are used for our presales and service customer interactions.

We have a disaster recovery, business continuation and backup policy. All of our inhouse ERP systems are currently hosted on the one of the leading web services and they are being backed up at a nearest availability zone with a daily end of the day snapshot. Our CRM database backup is taken daily on from our local servers.

For information on the risk to our IT systems, see *“Risk Factors – Failure or disruption of our IT, manufacturing automation systems and/or ERP systems may adversely affect our business, financial condition and results of operations.”* on page 27.

## **Insurance**

We maintain insurance policies which cover our showrooms, sales outlets, after-sales service outlets and other properties to protect us against loss in the case of fire, special perils, burglary and housebreaking and to protect our vehicles and equipment. Further, we maintain insurance coverage including, fidelity guarantee for insurance against infidelity of employees; money insurance policy for protecting money in transit and protecting cash whilst on premises during business hours; plate glass insurance policy for accidental breakage of fixed plate glass in our showrooms, service centers and other units; and internal risk insurance for cases of bodily injuries, property damage, and damage to our own vehicles. We also have a directors’ and officers’ policy for our directors and senior management.

For further information, see *“See “Risk Factors — Our insurance coverage may not be adequate to protect us against all potential losses, which may have a material adverse effect on our business, financial condition and results of operations.”* on page 44”.

## **Competition**

We operate in a highly competitive industry. The automotive retail business are price, location, selection and service. Each of our markets includes a number of well capitalized competitors that have extensive automotive retail managerial experience, retail locations and facilities. We face competition from (i) several companies that operate numerous automotive retail stores on a regional or national basis and online and mobile sales platforms. We compete with other dealerships that sell the same vehicle brands that we sell, as well as dealers and certain manufacturers that sell other vehicle brands that we do not represent in a particular market. Other dealerships have agreements with various OEMs and, as such, generally have access to new vehicles on the same terms as we have. We also compete with other dealers for qualified employees, particularly for general managers and sales and service personnel. Under most of our dealership agreements with the OEMs, acquisition of multiple dealerships of a given vehicle brand within a particular market or dealerships of a new vehicle brand is subject to obtaining the prior consent of the OEM.

We also compete with independent automobile service shops and service centre chains. The principal competitive factors in the parts and service business are customer service, expertise with the particular vehicle lines, location and price. We also compete with a broad range of financial institutions in our business of facilitating sale of finance and insurance products. The principal competitive factors in the finance and insurance business are product selection, convenience, price, contract terms, special offers from other institutions and the ability to finance vehicle protection and aftermarket products.

For more information about our industry, see *“Industry Overview”* on page 105.

## **Environment, Social and Governance (ESG)**

We are subject to Indian laws and regulations relating to the protection of the environment, human health and safety and have procedures in place to ensure compliance. Our Company understands the extent of impact its business has on the global community and recognizes its duty to conduct business in a socially responsible manner.

We are committed to minimize our impact on the natural environment and conduct business in an environmentally responsible manner. We have a strategic tie up with Charge+Zone a leading electric automobile charging solution provider with charging points across various cities in India. We have installed 3 single gun Type2 (L2) electric automobile battery chargers of 7.2KW at our showrooms in Delhi, Mumbai and Ahmedabad, and we have plans to add additional locations. Type-2 chargers are compatible with the Mercedes-Benz and Volkswagen electric vehicles. As dealers of Mercedes which has already launched an electric vehicle, we provide charging facilities at our locations and have 13 chargers installed across our Mercedes showrooms and workshops.

Our Company is an equal opportunity employer and has adopted policies, guidelines and procedures to prohibit discrimination based on race, caste, religion, colour, ancestry, marital status, gender, sexual orientation, age, nationality, ethnic origin, disability or any other protected characteristic as established by law. The Company respects the culture and beliefs of all its employees. We continuously review our existing human resource initiatives to make them more inclusive, employee engaging and skill-development oriented. We continue to lay emphasis on building and sustaining an excellent organization climate based on human performance.



We undertake several initiatives to promote employee health and quality of life. We provide our employees with the benefits, resources and flexibility to maintain and improve their wellness. We maintain adequate standards of occupational health, safety and well-being to ensure seamless manufacturing operations, protect our employees and meet legal requirements. In this regard, we have formulated a Safety, Health and Environment Policy.

We have an internal code of conduct, which covers all our employees and board of directors. To further facilitate our governance centric approach, we have invested in compliance management tools such as SAP-ERP for accounting transparency amongst other business practices.

### **Human Resources**

As of September 30, 2021, we had 3,562 employees including 255 trainees with 16.09% of our staff having been with us for between 5 and 10 years and 7.52% of our staff having been with us over 10 years.

We do not have any union at our sales or after-sales service and spares outlets. We have not experienced any major work stoppages due to labour disputes or cessation of work in the last three years.

### **Training**

Our staff are trained periodically in sales and service. Specific training sessions are organized at the time of introduction of changes to existing models of vehicles or introduction of new models or sales schemes. Our staff members are also required to undergo specific periodic training sessions each year with the respective OEMs as per the terms of the dealership agreements or retailer and repairer agreements entered into by us with the OEMs.

### **Intellectual Property**

Our trade name “Group Landmark” (applied for) and 39 trademarks including our lion logo and various graphic representations of our name and initial “L” as well as a graphic representation of “WoW workshop on wheels” are registered with the Trademarks Registry, Ahmedabad. The following is our registered lion logo trademark:



Further, our subsidiary, Landmark  Automobiles Private Limited has 13 trademark applications filed with the Trademarks Registry, Mumbai.

### **Properties**

Our registered office is located at Landmark House, Opp. AEC, S. G. Highway, Thaltej, Near Gurudwara, Ahmedabad 380 059, Gujarat, India, which is owned by our subsidiary, LAPL and occupied by the Company on a lease basis.

In addition, our Mercedes-Benz outlet at Kolkata is owned by LCEPL. All other properties of the Group Landmark are held on a lease basis in the states of Maharashtra, Uttar Pradesh, Gujarat, Haryana, Delhi, Madhya Pradesh, Punjab and West Bengal. Our leased properties are in the name of our Company and the Subsidiaries. We use our owned and leased properties for showrooms, offices, service centers, stockyards and drive parking places. Our lease agreements for some properties have expired, and we have applied for their renewal. For further information, see “*Risk Factors-We are subject to risks associated with leasing space such as termination of, non-renewal of or failure to enforce, register or adequately stamp our lease agreements and we may not be able to operate our dealerships successfully.*” on page 42.

### **Corporate Social Responsibilities**

Our corporate social responsibilities (“CSR”) initiatives are focused on our green initiative which includes planting trees across Gujarat and Madhya Pradesh. Our tree planting project is part of part of ‘Mission Million Trees’ of Ahmedabad Municipal Corporation. In Fiscal 2021, Fiscal 2020 and Fiscal 2019, we have allocated ₹0.59 million, ₹Nil and ₹Nil to our CSR activities. We received an award for the best CSR initiative from the Federation of Automobile Dealers Association in 2019.

### **Recent Developments – COVID 19 Pandemic**

The outbreak of COVID-19 was declared a pandemic by the World Health Organization on March 11, 2020, and as of the date of this Draft Red Herring Prospectus, it is still ongoing and rapidly evolving. The GoI initiated a nation-wide

lockdown from March 24, 2020, that lasted until May 31, 2020 and has been extended periodically by varying degrees by state governments and local administrations. As our operations were not considered an essential service, we were required to discontinue our sales and services operations at our outlets during the nationwide lockdown.

Although the nationwide lockdown was lifted on June 1, 2020, restrictions on non-essential activities and travel were imposed until August 31, 2020, in multiple states across districts that were witnessing increases in COVID-19 cases. The second wave of COVID-19 infections impacted India in April, May and June 2021. The second wave resulted in significant strain on the health infrastructure in the country resulting in several states announcing lockdown measures. The second wave also resulted in a large part of the population working from home and implementing social distancing measures. In June 2021, the reported cases of COVID-19 from the second wave declined and the GoI and state governments started gradually easing some of the strict precautionary measures.

Our business, financial condition, results of operations and prospects were materially and adversely affected due to the COVID -19 pandemic, and these adverse effects included (but were not limited to) the following:

- During the national lockdown, we experienced a complete suspension of activities at substantially all of our sales outlets and after-sales service and spares centers for extended periods of time, the length of which depended on the location.
- With the partial and gradual easing of the lockdown, we experienced overall low consumer demand in the automotive markets, and consequently reduced footfalls at all of our outlets during the first and second quarter of Fiscal 2021. We experienced improved business conditions and improved financial results in the third and fourth quarters of Fiscal 2021. In the first and second quarters of Fiscal 2021, our revenues declined by 79% and 15%, respectively, as compared to first and second quarters of FY 2020. Improved business conditions in the third and fourth quarter of Fiscal 2021, enabled us to show an increase of 1% and 53%, respectively, in the third and fourth quarters of Fiscal 2021 as compared to third and fourth quarters of Fiscal 2020.
- Due to second wave, in the first quarter of Fiscal 2022, we again experienced low consumer demand and reduced footfall at all of our outlets but not as pronounced as the decline in the first quarter of Fiscal 2021. Our revenue in the first quarter of Fiscal 2022 increased by 377% as compared to the first quarter of Fiscal 2021 but declined by 21% from the fourth quarter of Fiscal 2021.
- As the impact of the second wave lessened, we experienced a strong second quarter of Fiscal 2022, and our revenues increased by 92% as compared to the second quarter of Fiscal 2021 and increased by 64% from the first quarter of Fiscal 2022.
- Our after-sales service and spare parts revenue also declined in the first and second quarters of Fiscal 2021 but returned to previous levels in the third and fourth quarters. Our after -sales service and spare parts revenue also declined during the second wave in April 2021 and May 2021 but again returned to previous levels by July 2021.
- In response to the lock-down restrictions, we shifted our focus to digital and on-line channels. We facilitated enquiries throughour websites, social media platforms and also contacted customers through video conferencing means.

For further information on the impact of COVID-19 on our business and the risks associated with COVID-19 to our business, see *“Risk Factors – The COVID-19 pandemic had a material adverse effect on our business, results of operation and financial condition and the continuing impact of the COVID-19 pandemic is uncertain and still evolving, and could continue to adversely affect our business, results of operations and financial condition.”* on page 33.

## KEY REGULATIONS AND POLICIES IN INDIA

The following description is a summary of certain sector specific laws and regulations in India, which are applicable to our business and operations. The information detailed in this section has been obtained from publications available in the public domain. The regulations and their descriptions set out below may not be exhaustive and are only intended to provide general information to the bidders and are neither designed nor intended to substitute for professional legal advice. The information in this section is based on the current provisions of applicable laws in India that are subject to change or modification by subsequent legislative, regulatory, administrative or judicial decisions.

We operate in the automotive retail business through our network of dealerships spread across 31 cities in eight states and union territories including Maharashtra, Uttar Pradesh, Gujarat, Haryana, Madhya Pradesh, Punjab, West Bengal and the National Capital Territory of Delhi. For details, see “*Our Business*” on page 133.

Under the provisions of various Central Government and State Government statutes and legislations, our Company and our Subsidiaries are required to obtain and periodically renew certain licenses or registrations and to seek statutory permissions to conduct our business and operations. For details, see “*Government and Other Approvals*” on page 328.

Given below is a brief description of certain relevant legislations that are currently applicable to the business carried on by us.

### INDIAN LAWS APPLICABLE TO OUR COMPANY

#### I. Key laws applicable to our business operations

The key laws applicable to the automotive industry include:

- *The Batteries (Management and Handling) Rules, 2001 (“Batteries Rules”)*

The Batteries Rules apply to every manufacturer, importer, re-conditioner, assembler, dealer, recycler, auctioneer, consumer and bulk consumer involved in manufacture, processing, sale, purchase and use of batteries or components thereof. The Batteries Rules provides that it shall be the responsibility of a manufacturer, importer, assembler and re-conditioner to, inter alia, ensure that the used batteries are collected back against new batteries sold as per the applicable law and to ensure that used batteries collected back are of similar type and specifications as that of the new batteries sold. In addition, the manufacturer, importer, assembler and re-conditioner is also required to file half-yearly returns of their sales and buy-back to the State Pollution Control Board in Form-I latest by June 30 and December 31 of every year, set up collection centres for collection of used batteries from consumers or dealers, ensure that used batteries collected are sent only to the registered recyclers, ensure safe transportation and create public awareness through advertisements and publications of hazards of lead, addresses of dealers and designated collection centres etc. As per the Batteries Rules, every dealer is required to file half-yearly returns of the sale of new batteries and buy-back of old batteries to the manufacturer in Form V by 31<sup>st</sup> May and 30<sup>th</sup> November of every year.

- Shops and Establishments Legislations

Under the provisions of local shops and establishments legislations applicable in the states in which establishments are set up, establishments are required to be registered as prescribed. Such legislations regulate the working and employment conditions of the workers employed in shops and establishments including commercial establishments and provide for fixation of working hours, rest intervals, overtime, holiday, leave, termination of service, maintenance of shops and establishments and other rights and obligations of the employers and employee. Our locations/units have to be registered under the shops and establishments legislations of the state where they are located.

- *Sale of Goods Act, 1930 (the “Sale of Goods Act”)*

The Sale of Goods Act governs contracts relating to sale of goods in India. It provides for the setting up of contracts where the seller transfers or agrees to transfer the title (ownership) in the goods to the buyer for consideration. The contracts for sale of goods are subject to the general principles of the law relating to contracts. A contract of sale may be absolute or conditional. The Sale of Goods Act, 1930 contains provisions in relation to the essential aspects of such contracts, including the transfer of ownership of the goods, delivery of goods, rights and duties of the buyer and seller, remedies for breach of contract and the conditions and warranties implied under a contract for sale of

goods.

- *Motor Vehicles Act, 1988 (“MVA”) and Central Motor Vehicles Rules, 1989 (“CMV Rules”)*

The MVA read with the CMV Rules is an umbrella legislation which regulates all aspects of road transport vehicles including licensing of drivers and conductors, registration of motor vehicles, control of motor vehicles through permits, licensing of driving schools, special provisions relating to state transport undertakings, traffic regulation and insurance. As per MVA and the CMV Rules, no person shall drive any motor vehicle in any public place or in any other place unless the vehicle is registered with the registering authority and the vehicle carries a registration mark displayed in the manner as specified in the MVA and the CMV Rules. The CMV Rules also state that no person shall establish or maintain any driving school or establishment for imparting instructions for hire or reward in driving motor vehicles without a license in Form 11 granted by the licensing authority.

## II. Laws governing foreign investments

Foreign investment in India is governed by the provisions of FEMA along with the rules, regulations and notifications made by RBI thereunder, and the Consolidated Foreign Direct Investment Policy (“**FDI Policy**”) issued by the Department for Promotion of Industry and Internal Trade (“**DPIIT**”) from time to time.

Under the current consolidated FDI Policy, effective from October 15, 2020, issued by the DPIIT including and modifications thereto or substitutions thereof, issued from time to time, 100% FDI through automatic route is permitted in the retail trading sector.

## III. Key applicable intellectual property laws

- *The Copyright Act, 1957 (“Copyright Act”)*

The Copyright Act governs copyrights subsisting in original literary, dramatic, musical or artistic works, cinematograph films, and sound recordings, including computer programmes, tables and compilations including computer databases. Even while copyright registration is not a prerequisite for acquiring or enforcing a copyright in an otherwise copyrightable work, registration under the Copyright Act acts as a prima facie evidence of the particulars entered therein and helps expedite infringement proceedings and reduce delay caused due to evidentiary considerations.

- *Trade Marks Act, 1999 (“Trade Marks Act”)*

The Trade Marks Act provides for the application and registration of trademarks in India. The purpose of the Trade Marks Act is to grant exclusive rights to marks such as a brand, label, heading, among others, and to obtain relief in case of infringement of such marks. Application for the registration of trademarks has to be made Controller-General of Patents, Designs and Trade Marks who is a Registrar of Trademarks for the purposes of the Trade Marks Act. The Trade Marks Act prohibits registration of deceptively similar trademarks. It also provides for penalties for infringement, falsifying and falsely applying trademarks and using them to cause confusion among the public.

## IV. Environment Regulations

We are subject to various environment regulations as the operation of our establishments might have an impact on the environment in which they are situated. The basic purpose of the statutes given below is to control, abate and prevent pollution. In order to achieve these objectives, Pollution Control Boards (“**PCBs**”), which are vested with diverse powers to deal with water and air pollution, have been set up in each state. The PCBs are responsible for setting the standards for maintenance of clean air and water, directing the installation of pollution control devices in industries and undertaking inspection to ensure that industries are functioning in compliance with the standards prescribed. These authorities also have the power of search, seizure and investigation. All industries are required to obtain consent orders from the PCBs, which are indicative of the fact that the industry in question is functioning in compliance with the pollution control norms. These consent orders are required to be kept renewed.

- *Environment Protection Act, 1986 (“EPA”) and Environment (Protection) Rules, 1986*

The EPA is the umbrella legislation in respect of the various environmental protection laws in India. Under the EPA, the Government of India is empowered to take any measure it deems necessary or expedient for protecting and improving the quality of the environment and preventing and controlling environmental pollution. This includes

rules for, *inter alia*, laying down standards for the quality of environment, standards for emission of discharge of environment pollutants from various sources, as provided under the Environment (Protection) Rules, 1986, inspection of any premises, plant, equipment, machinery, examination of manufacturing processes and materials likely to cause pollution. Penalties for violation of the EPA include fines up to ₹ 100,000 or imprisonment of up to five years, or both. In case the failure or contravention continues, an additional fine may be imposed which may extend to five thousand rupees for every day during which such failure or contravention continues and the imprisonment can extend up to seven years if the violation of the EPA continues. There are provisions with respect to certain compliances by persons handling hazardous substances, furnishing of information to the authorities in certain cases, establishment of environment laboratories and appointment of Government analysts.

- *Water (Prevention and Control of Pollution) Act, 1974 (“Water Act”) and Water (Prevention and Control of Pollution) Cess Act, 1977*

The Water Act aims to prevent and control water pollution as well as restore water quality by establishing and empowering the central and state pollution control board. Under the Water Act, any person establishing any industry, operation or process, any treatment or disposal system, using any new or altered outlet for the discharge of sewage or new discharge of sewage, must obtain the consent of the relevant state pollution control board, which is empowered to establish standards and conditions that are required to be complied with. Further, the Water Act empowers the state boards to lay down standards of treatment of sewage and trade effluents to be discharged into any particular stream taking into account the minimum fair-weather dilution available in that stream and the tolerance limits of pollution permissible in the water of the stream, after the discharge of such effluents. In certain cases, the state pollution control board may cause the local magistrates to restrain the activities of such person who is likely to cause pollution. Penalty for the contravention of the provisions of the Water Act include imposition of fines and/or imprisonment.

- *Air (Prevention and Control of Pollution) Act, 1981 (“Air Act”)*

The Air Act has been enacted to provide for the prevention, control and abatement of air pollution. The Air Act was enacted with a view to protect the environment and surroundings from any adverse effects of the pollutants that may emanate from any factory or manufacturing operation or activity. It lays down the standards with regard to emissions and pollutants that are a direct result of any operation or activity. Pursuant to the provisions of the Air Act, any person, establishing or operating any industrial plant within an air pollution control area, must obtain the consent of the relevant state pollution control board, prior to establishing or operating such industrial plant. The state pollution control board may then grant consent, subject to mentioned conditions relating to pollution control equipment to be installed at the facilities. No person operating any industrial plant in any air pollution control area is permitted to discharge the emission of any air pollutant in excess of the standards laid down by the state pollution control board.

- *Hazardous and Other Wastes (Management and Transboundary Movement) Rules, 2016, (“Hazardous Wastes Rules”)*

The Hazardous Wastes Rules impose an obligation on every occupier of a facility generating hazardous waste to deploy safe and environmentally sound measures for handling of hazardous waste generated at such facility. Every person engaged in generation, processing, treatment, packaging, storage, transportation, use, collection, destruction, conversion, offering for sale and transfer of hazardous waste, must obtain an approval from the applicable state pollution control board. The occupier, the importer, the transporter and the operator of disposal facility are liable for damages to the environment or third party resulting from the improper handling and disposal of hazardous waste.

- *Manufacture, Storage and Import of Hazardous Chemical Rules, 1989 (“Hazardous Chemical Rules”)*

The Hazardous Chemical Rules were formulated by the Central Government in exercise of the powers conferred to them under the Environment Protection Act, 1986. The rules seek to regulate the manufacture, storage and import of hazardous chemicals in India. The Hazardous Chemical Rules recognise a list of chemicals that qualify as hazardous for the purpose of these rules, and requires the occupier, who has control over these substances to ensure that adequate steps are taken in the facility to prevent any major accidents. Further, the occupier is also required to provide safety reports as required by the provisions of the Hazardous Chemical Rules, and also prepare an on-site and off-site emergency plan with details on how to manage major accidents.

- Fire prevention and life safety measures

We are subject to the fire control and safety rules and regulations framed by the governments of the states and union

territory in which we operate, as given below:

- (i) Maharashtra Fire Prevention & Life Safety Measure Act, 2006 and Maharashtra Fire Prevention and Life Safety Measures Rules, 2009;
- (ii) Uttar Pradesh Fire Prevention and Fire Safety Act, 2005;
- (iii) Gujarat Fire Prevention and Life Safety Measures Act, 2013;
- (iv) Haryana Fire Service Act, 2009;
- (v) Punjab Fire Prevention and Fire Safety Act, 2004;
- (vi) West Bengal Fire Services Act, 1950; and
- (vii) Delhi Fire Service Act, 2007 and Delhi Fire Service Rules, 2010.

## V. Tax Legislations

The tax related laws that are applicable to our Company include the Central Goods and Services Tax Act, 2017 and relevant goods and services acts passed by various state governments, Income Tax Act, 1961, Income Tax Rules, 1962, as amended by the Finance Act in respective years, along with the applicable rules framed thereunder. Further, the Goods and Services Acts enacted by the following states and union territory in which we operate shall also be applicable.

## VI. Labour laws and Regulations

In respect of our business and operations, our Company and Subsidiaries are also required to obtain licences and registrations and make timely payments as prescribed under various central labour laws and regulations including, *inter alia*

- Child Labour (Prohibition and Regulation) Act, 1986;
- Employees' Provident Funds and Miscellaneous Provisions Act, 1952; \*\*\*\*
- Employees' State Insurance Act, 1948; \*\*\*\*
- Factories Act, 1948; \*\*
- Industrial Disputes Act, 1947 and Industrial Disputes (Central) Rules, 1957; \*\*\*
- Industrial Employment (Standing Orders) Act, 1946; \*\*\*
- Maternity Benefit Act, 1961; \*\*\*\*
- Minimum Wages Act, 1948; \*
- Motor Transport Workers Act, 1961;
- Payment of Bonus Act, 1965; \*
- Payment of Gratuity Act, 1972; \*\*\*\*
- Payment of Wages Act, 1936; \*
- Equal Remuneration Act, 1976; \* and
- Employee's Compensation Act, 1923

\* *The Code on Wages, 2019 received the assent of the President of India on August 8, 2019 and proposes to subsume four existing laws namely, the Payment of Wages Act, 1936, the Minimum Wages Act, 1948, the Payment of Bonus Act, 1965 and the Equal Remuneration Act, 1976. The provisions of this code will be brought into force on a date to be notified by the Central Government.*

\*\* *The Government of India enacted 'The Occupational Safety, Health and Working Conditions Code, 2020' which received the assent of the President of India on September 28, 2020. The provisions of this code are proposed to be brought into force on April 1, 2021. It proposes to subsume several separate legislations, including the Factories Act, 1948, the Contract Labour (Regulation and Abolition) Act, 1970, the Inter-State Migrant Workmen (Regulation of Employment and Conditions of Service) Act, 1979 and the Building and Other Construction Workers (Regulation of Employment and Conditions of Service) Act, 1996.*

\*\*\* *The Government of India enacted 'The Industrial Relations Code, 2020' which received the assent of the President of India on September 28, 2020. The provisions of this code are proposed to be brought into force on April 1, 2021. It proposes to subsume three separate legislations, namely, the Industrial Disputes Act, 1947, the Trade Unions Act, 1926 and the Industrial Employment (Standing Orders) Act, 1946.*

\*\*\*\* *The Government of India enacted 'The Code on Social Security, 2020 which received the assent of the President of India on September 28, 2020. The provisions of this code are proposed to be brought into force on April 1, 2021. It proposes to subsume several separate legislations including the Employee's Compensation Act, 1923, the Employees' State Insurance Act, 1948, the Employees' Provident Funds and Miscellaneous Provisions Act, 1952, the Maternity Benefit Act, 1961, the Payment of Gratuity Act, 1972, the Building and Other Construction Workers (Regulation of Employment and Condition of Service) Act, 1996.*

Furthermore, the Company and Subsidiaries are also required to comply with the various labour law statutes and regulations enacted across states where our dealerships and service centres are located.

## VII. Other Regulations

- *Consumer Protection Act, 2019 (“CPA 2019”)*

The Consumer Protection Act, 2019 superseded the Consumer Protection Act, 1986 and came into force on July 20, 2020. The CPA 2019 has introduced certain definitions including, *inter alia*, ‘product liability’, product manufacturer’ and ‘defect’. The CPA 2019 further established Central Consumer Protection Authority to protect, promote and enforce the rights of the consumers.

In addition to the above, our Company and Subsidiaries are also required to, among other things, comply with the provisions of certain other legislations including the Electricity Act, 2003 read with the Indian Electricity Rules, 1956 and the relevant Panchayat/ Municipality/ Corporation Acts enacted by the states of Maharashtra, Uttar Pradesh, Gujarat, Haryana, Madhya Pradesh, Punjab, West Bengal and the union territory of National Capital Territory of Delhi.

## VIII. Applicable Plans and Policies

- *The Automotive Mission Plan, 2016-2026 (“Automotive Mission Plan”)*

The Automotive Mission Plan, 2016-2026 was released by the Department of Heavy Industry jointly with Indian Automobile Industries in September 2015, and it seeks to define the path of evolution of the automotive ecosystem in India including specific regulations and policies that govern research, design, technology, testing, manufacturing, imports/exports, sales, use, repair, and recycling of automotive vehicles, components and services. The Automotive Mission Plan aims to achieve various objectives including *inter alia*, to make the Indian automotive industry a top job creating industry and the prime mover of manufacturing sector as well as of the “Make in India” programme, and to promote safe, efficient and comfortable mobility, with an eye on environmental protection and affordability through both public and personal transport options. The Automotive Mission Plan seeks to impose norms pertaining to auto fuels and emissions, inspection and certification among others. The plan recognises the need of an articulate system to ensure that the vehicles are compliant with the global standards of safety. Under the Automotive Mission Plan, specific interventions are envisaged to sustain and improve manufacturing competitiveness and to address challenges of environment and safety.

- *Electric Vehicle Policy*

The ever-increasing vehicular population has been a concerning issue. Vehicles driven on traditional fuels form a major contributor of hazardous components to the environment. Further to the rapid depletion of fossil fuels, industries are shifting to eco-friendly technologies. The Central Government launched the Phase I of the Faster Adoption and Manufacturing of (Hybrid &) Electric Vehicles (FAME-India) Scheme in India (“**FAME Scheme**”) in 2015 under the National Electric Mobility Mission Plan, 2020 with an aim to promote eco-friendly vehicles in the country. Pursuant to the FAME Scheme, the state governments launched their respective electric vehicle policies (“**EV Policies**”). The EV Policies for the states of Maharashtra, Uttar Pradesh, Gujarat, Haryana, Madhya Pradesh, Punjab, West Bengal, and the union territory National Capital Territory of Delhi have made provisions for various percentages of subsidy that may be availed by the buyers of these vehicles. The Phase I of the FAME Scheme was allowed up to March 31, 2019. Thereafter, the Central Government has approved the Phase II of the FAME Scheme for a period of three years commencing from April 1, 2019. The scheme was put in place to encourage faster adoption of electric and hybrid vehicle by way of offering incentives on purchase of electric vehicles.

- *Bharat Stage (BS) VI Emission Standards (“BS-VI Standards”)*

The Indian Ministry of Road Transport and Highways issued a draft notification of Bharat Stage (BS) VI emission standards for all major on-road vehicle categories in India in February 2016. The adoption of these standards seeks to bring the Indian motor vehicle regulations into alignment with European Union regulations for light-duty passenger cars and commercial vehicles, heavy-duty trucks and buses, and two-wheeled vehicles. Taking a leap from the Bharat Stage-V emission standards, these standards were enforced amid the lockdown on April 1, 2020. The BS-VI Standards set forth emission standards, type approval requirements, on-board diagnostic system specifications, and durability levels for all major vehicle categories in India. Additionally, the BS-VI standards also have specifications for reference and commercial fuels.

## HISTORY AND CERTAIN CORPORATE MATTERS

### Our brief history

Our Company was originally incorporated as ‘Landmark Insurance Broking Private Limited’ in Mumbai, Maharashtra, as a private limited company under the Companies Act, 1956, pursuant to a certificate of incorporation dated February 23, 2006, issued by the RoC, Mumbai. The name of our Company was subsequently changed to ‘Landmark Cars Private Limited’ pursuant to a fresh certificate of incorporation granted by the RoC, Mumbai on May 6, 2009. Thereafter, our Company was converted into a public limited company pursuant to a special resolution passed in the extra ordinary general meeting of the shareholders held on November 10, 2021 and the name of our Company was changed to our present name ‘Landmark Cars Limited’, pursuant to a fresh certificate of incorporation issued by the RoC on December 3, 2021.

### Changes in our Registered Office

Except as disclosed below, there has been no change in the address of our Registered Office since incorporation.

Effective date of change	Details of change	Reason for change
September 23, 2009	The registered office of our Company was changed from Landmark, 554, Dr. G M Bhosale Road, Worli, Mumbai 400 018, Maharashtra to 3 <sup>rd</sup> Floor, Landmark House, Opp. AEC, Near Gurudwara, Thaltej Cross Road, S.G. Highway, Ahmedabad 380 059, Gujarat	Administrative convenience
February 6, 2015	The registered office of our Company was changed from 3 <sup>rd</sup> Floor, Landmark House, Opp. AEC, Near Gurudwara, Thaltej Cross Road, S.G. Highway, Ahmedabad 380 059, Gujarat to Sun Court, Survey no. 383/P, FP-37 & 38, Near Sola flyover, S.G. Road, Ahmedabad, 380 063, Gujarat	Administrative convenience
May 17, 2021	The registered office of our Company changed from Sun Court, Survey no. 383/P, FP-37 & 38, Near Sola flyover, S.G. Road, Ahmedabad, 380 063 to Landmark House, Opp. AEC, S.G. Highway Thaltej, Near Gurudwara, Ahmedabad 380 059, Gujarat	Administrative convenience

### Main objects of our Company

The main objects contained in our Memorandum of Association are as follows:

- “1. To buy, sell, market, let on hire, import, export, repair, maintain and deal in all kinds and descriptions of automobiles, whether propelled or assisted by means of petrol, spirit, gas, mineral oils, electricity, animal, atomic or any kind of fuel or power or energy including auto cycles, motor cycles, scooters, mopeds, motor cars, auto rickshaws, trucks, tractors, delivery axels, tankers, ferries, buses, mini buses, matador tempo or other vehicles and their spare parts, components, accessories and ancillary equipment's including automotive equipment's, axles, hydraulic jacks, airbrakes equipment's, suspension units, pressed steel cabs, bearing, piston rings, crankshafts, truck bodies.
2. To carry on the business of distributions and servicing of motor insurance policy (ies) including add-ons.
3. To carry on the business or provide services of Business Processes Outsourcing not limited to marketing, customer relationship management services, Customer Contact Service Centers or Call Center (In bound and / or out bound) activities wherein the information / data shall be collected/acquired by means of audio or audio & video and/or messenger and/or feedbacks-and/ or such web support mode and such data shall be entered, management, supervised, processed, stored, retrieved, shared, operated by means of required software's/applications and / or in consultation of service providers, if any, which shall facilitate/provide all required kinds of analytical purpose relating to marketing advertising, technical research, back office or such other services as per the needs of the Company and/or its Clients and the Company shall carry on such business/ provide incidental/ ancillary/support/ services enabling herein.”

The main objects as contained in the Memorandum of Association enables our Company to carry on the business presently being carried out.



## Amendments to our Memorandum of Association

Set forth below, are the amendments to our Memorandum of Association in the 10 years preceding the date of this Draft Red Herring Prospectus:

Date of Shareholders Resolution/ Effective Date	Particulars
December 7, 2013	Clause V of our Memorandum of Association was substituted to reflect the conversion of 10,000 unissued equity shares of ₹ 10 each into 10,000 8% redeemable non-cumulative non-convertible preference shares of face value of ₹ 10 each and 990,000 equity shares of face value of ₹ 10 each. The authorized share capital of our Company became ₹ 10,000,000
December 9, 2014	Clause V of our Memorandum of Association was substituted to reflect the reclassification of the authorized share capital of our Company from ₹ 10,000,000 divided into 990,000 equity shares of face value of ₹ 10 each and 10,000 8% redeemable non-cumulative non-convertible preference shares of ₹ 10 each to ₹ 2,00,00,000 divided into 16,90,000 equity shares of face value of ₹ 10 each, 10,000 8% redeemable non-cumulative non-convertible preference shares of face value of ₹ 10 each and 300,000 0.01% cumulative compulsorily convertible preference shares of face value of ₹ 10 each
September 29, 2016	Clause V of our Memorandum of Association was substituted to reflect the reclassification of the authorized share capital of our Company from ₹ 20,000,000 comprising of 1,690,000 shares of ₹ 10 each, 10,000 8% redeemable non-cumulative non-convertible preference shares of face value of ₹ 10 each and 300,000 0.01% cumulative compulsorily convertible preference shares of ₹ 10 each to ₹ 20,000,000 comprising of 2,000,000 equity shares of face value of ₹ 10 each
March 18, 2017	Clause V of our Memorandum of Association was substituted to reflect an increase in the authorized share capital of our Company from ₹ 20,000,000 divided into 2,000,000 equity shares of face value of ₹ 10 each to ₹ 100,000,000 divided into 10,000,000 equity shares of face value of ₹ 10 each
December 22, 2017	Clause III of our Memorandum of Association was amended to reflect insertion of sub-sub clause 2 of sub-clause A stating the main objects to be pursued by the Company on its incorporation
September 26, 2018	Clause V of our Memorandum of Association was substituted to reflect an increase in the authorized share capital from ₹ 100,000,000 divided into 10,000,000 equity shares of face value of ₹ 10 each to ₹ 190,000,000 divided into 19,000,000 equity shares of face value of ₹ 10 each
May 13, 2019	Clause III of our Memorandum of Association was amended to insert clause number 3 after clause number 2: <i>“3. To carry on the business of providing services of Business Process Outsourcing not limited to marketing, customer relationship management services, Customer Contact Service Centres or call center (in bound and/or out bound) activities wherein the information/data shall be collected/ acquired by means of audio or audio &amp; video and/or messenger and/or feedback and/or such web support mode and such data shall be entered, management, supervised, processed, stored, retrieved, shared, operated by means of required software’s/ applications and/or in consultation of service providers, if any, which shall facilitate/provide all required kinds of analytical purpose relating to marketing, advertising, technical, research, back office or such other services as per the needs of the Company and/or its Clients and the Company shall carry on such business/ provide incidental/ancillary/support/ services enabling herein.”</i>
May 14, 2019	Clause V of our Memorandum of Association was substituted to reflect an increase in the authorized share capital of our Company pursuant to the Schemes of Arrangement from ₹ 190,000,000 divided into 19,000,000 equity shares of face value of ₹ 10 each to ₹ 270,500,000 divided into 200,000 8% redeemable preference shares of face value of ₹ 10 each and 26,850,000 equity shares of face value of ₹ 10 each
November 10, 2021	Clause V of our Memorandum of Association was substituted to reflect the sub-division of the face value of equity shares from ₹ 10 to ₹ 5. The authorized share capital of our Company was amended from ₹ 270,500,000 comprising of 26,850,000 equity shares of face value of ₹ 10 each and 200,000 redeemable preference shares of face value of ₹ 10 each to ₹ 270,500,000 comprising of 53,700,000 Equity Shares of face value of ₹ 5 and 400,000 redeemable preference shares of face value of ₹ 5

Date of Shareholders Resolution/ Effective Date	Particulars
	Clause I of our Memorandum of Association was amended to reflect the change in the name of our Company from “ <i>Landmark Cars Private Limited</i> ” to “ <i>Landmark Cars Limited</i> ”

### Major events and milestones of our Company and its Subsidiaries

The table below sets forth some of the major events and milestones in the history of our Company and its Subsidiaries:

Calendar Year	Particulars
1998	We commenced our Honda dealership in Ahmedabad
2009	We commenced our Volkswagen dealership in Ahmedabad and Gujarat
	We commenced our Mercedes-Benz dealership in Ahmedabad
2012	We commenced our Ashok Leyland dealership in Ahmedabad, Kheda, Anand, Gandhinagar, Vadodara, Panchmahal and Dahod in Gujarat
2013	We commenced our Mercedes-Benz Kolkata dealership in West Bengal
2014	Investment by TPG Growth in our Company
2016	We commenced our Renault dealership in Punjab
2018	We acquired a competing Volkswagen dealer in Ahmedabad
2019	Composite Scheme of arrangement and amalgamation in the nature of demerger and amalgamation between our Company, Landmark Commercial Vehicles Private Limited and Watermark Commercial Vehicles Private Limited and their respective shareholders and creditors, approved and sanctioned by the National Company Law Tribunal, Ahmedabad by way of its order dated April 4, 2019
	Composite Scheme of arrangement and amalgamation in the nature of demerger and amalgamation between our Company, Landmark Automobiles Private Limited and Watermark Automobiles Private Limited and their respective shareholders and creditors, approved and sanctioned by the National Company Law Tribunal, Ahmedabad by way of its order dated April 4, 2019, read with order dated April 15, 2019
	Composite Scheme of arrangement and amalgamation in the nature of demerger and amalgamation between our Company, Automark Motors Private Limited and Watermark Vehicles Private Limited and their respective shareholders and creditors, approved and sanctioned by the National Company Law Tribunal, Ahmedabad by way of its order dated April 4, 2019, read with order dated April 15, 2019
2021	Appointed as a dealer for Jeep in Ludhiana and Jalandhar
	We opened a Jeep connect showroom in Thane, Maharashtra
	Acquisition of four service centres of Mercedes-Benz, as a going concern, on a slump sale basis from Shaman Wheels Private Limited in Mumbai and Navi Mumbai

### Awards, accreditations or recognitions

The table below sets forth some of the key awards, accreditations and recognitions received by our Company and its Subsidiaries:

Sr. No.	Awards, accreditations, and recognitions	Year of Award
1	Platinum Award for Best Overall Performance - 2010 Category B Benchmark Cars, Ahmedabad	2010
2	Highest volume achiever – Bronze was awarded to Landmark Honda at the Annual Dealer Convention, New Delhi	2013
3	HR Partner of the Year 2013 was awarded to Benchmark Cars, Gujarat	2013
4	Exceptional performance in sales satisfaction was awarded to Landmark Honda Ahmedabad for the sales period July – September 2015 by Honda Cars India Limited.	2015
5	Mercedes Benz Winner of the best place to work award for 2015 (Category 2) was awarded to Benchmark Cars, Gujarat	2015
6	Benchmark Cars – Gujarat was awarded the Best Partner for Daimler Financial Services Category A H1-2018	2018
7	Group Landmark was awarded the “Customer Centricity” award by Autocar	2019
8	Group Landmark was awarded top dealer of the year (West) at the Auto Retail Forum	2019

Sr. No.	Awards, accreditations, and recognitions	Year of Award
9	Most innovative marketing practices dealer award at the Volkswagen Annual Brand Conference 2019	2019
10	Vibrant power award at the Volkswagen Annual Brand Conference 2019	2019
11	Group Landmark was recognized as one of the 'Top 50 companies with Great People Managers in the Great People Manager Study 2019' by the Great Manager Institute	2019
12	Best volume contribution was awarded to Benchmark Motors Private Limited (Mumbai/ Punjab - Rank 3) at the Renault Dealer Conference 2021	2021
13	Group Landmark was awarded the Business leader of the year - after sales excellence at the World Leadership Congress and Awards	2021
14	Best new car retail performance was awarded to Volkswagen at the Annual Business & TCO Conference 2021	2021

### Our holding company

As on the date of this Draft Red Herring Prospectus, our Company does not have a holding company.

### Subsidiaries, associates or joint ventures

We do not have any associates or joint ventures. For details with respect to our Subsidiaries, see "Our Subsidiaries" beginning on page 173.

### Time/cost overrun

There have been no time or cost over-runs in setting up of projects by our Company.

### Defaults or rescheduling/ restructuring of borrowings with financial institutions/banks

As on the date of this Draft Red Herring Prospectus, there have been no defaults, restructuring or rescheduling of borrowings availed by our Company from financial institutions or banks.

### Details of material acquisitions or divestments of business/undertakings in the last 10 years

Except as disclosed below, our Company has not acquired or divested any business/undertaking in the 10 years preceding the date of this Draft Red Herring Prospectus:

(₹ in million)				
Calendar Year	Relevant OEM	Location	Details of acquisition	Total cost of acquisition*
2021	Mercedes-Benz	Mumbai and Thane	Acquisition of business of servicing of Mercedes-Benz vehicles as a going concern on "slump sale" basis from Shaman Wheels Private Limited	350.00 <sup>#</sup>
	Volkswagen	Surat	Purchase of fixed assets	39.10
	Honda	Vapi	Purchase of fixed assets	10.00
	Jeep and Fiat	Punjab	Purchase of assets, spares and accessories	5.81
2018	Volkswagen	Ahmedabad	Purchase of fixed assets	90.00
2016 and 2017	Renault	Punjab	Purchase of fixed assets	245.35
2013	Mercedes-Benz	Kolkata	Purchase of fixed assets	125.37
<b>Total</b>				<b>865.63</b>

<sup>#</sup> Total consideration payable could range from ₹350-700 million, subject to any downward adjustment that may be required as a result of COVID-19-related lockdowns as per the terms of the business transfer agreement.

\*Does not include goods and services tax paid.

### Launch of key products or services, entry into new geographies or exit from existing markets, capacity/facility creation, location of plants

For details of key products or services launched by our Company, entry into new geographies or exit from existing markets, location of our sales outlets/service and spare parts outlets, see "Our Business" and "- Major events and

*milestones of our Company and its Subsidiaries*” on pages 133 and 169. There has been no capacity/facility creation in our Company.

### **Mergers or amalgamations in the last 10 years**

Except as disclosed below, our Company has not undertaken any merger or amalgamation in the 10 years preceding the date of this Draft Red Herring Prospectus.

#### **Composite scheme of arrangement and amalgamation in the nature of demerger and amalgamation between our Company, Automark Motors Private Limited (“AMPL/Transferor”) and Watermark Vehicles Private Limited (“WVPL”) and their respective shareholders and creditors, approved and sanctioned by the National Company Law Tribunal, Ahmedabad by way of its order dated April 4, 2019 read with the order dated April 15, 2019 (“Scheme of Arrangement - I”)**

A composite scheme of arrangement was filed by AMPL, WVPL and our Company (together with WVPL, as the “**Resulting Companies**”) before the National Company Law Tribunal, Ahmedabad Bench (“**NCLT**”), under Sections 230 to 233, and other applicable provisions of the Companies Act, 2013 (“**Scheme of Arrangement-I**”), seeking approval for the composite scheme of arrangement and amalgamation of the Transferor and Resulting Companies. The appointed date for the Scheme of Arrangement-I was April 1, 2018 (“**Appointed Date**”). The Scheme of Arrangement-I was authenticated pursuant to the order of the NCLT on April 4, 2019 read with order dated April 15, 2019. In terms of the Scheme of Arrangement-I, the Transferor stood demerged and amalgamated with the Resulting Companies as a going concern, and all assets, liabilities, licences, permits, registrations, contracts, employees, etc., as applicable, stood transferred or deemed to be transferred to and vested in the Resulting Companies. In consideration of the assets, liabilities, and undertakings pertaining to the business of operation of showrooms to buy and sell automobiles of a single brand “Volkswagen”, the operation of workshops and garages to repair and service the automobiles of AMPL (“**Demerged Undertaking**”) being transferred to WVPL, our Company issued and allotted 13,624 equity shares of our Company of ₹10 each for every 10,000 equity shares of AMPL of ₹10 each. Further, in consideration of the assets, liabilities and undertakings pertaining to the group investment business (“**Residual Business**”) of AMPL being transferred to our Company, our Company issued and allotted 85 equity shares of our Company of ₹10 each for every 10,000 equity shares of AMPL of ₹10 each. Pursuant to the Scheme of Arrangement - I, AMPL stood dissolved without being wound-up and its name was struck-off from the records of the relevant registrar of companies. Upon sanctioning of the Scheme of Arrangement – I, the name of WVPL was changed to AMPL. For details of such allotment, see “*Capital Structure- Notes to the Capital Structure - Equity share capital history of our Company*” on page 76.

#### **Composite scheme of arrangement and amalgamation in the nature of demerger and amalgamation between our Company, Landmark Automobiles Private Limited (“Transferor/LAPL”) and Watermark Automobiles Private Limited (“WAPL”) and their respective shareholders and creditors, approved and sanctioned by the National Company Law Tribunal, Ahmedabad by way of its order dated April 4, 2019 read with order dated April 15, 2019 (“Scheme of Arrangement - II”)**

A composite scheme of arrangement was filed by LAPL, WAPL and our Company (together with WAPL, as the “**Resulting Companies**”) before the National Company Law Tribunal, Ahmedabad Bench (“**NCLT**”), under Sections 230 to 233, and other applicable provisions of the Companies Act, 2013, seeking approval for the composite scheme of arrangement and amalgamation of the Transferor and the Resulting Companies. The appointed date for the Scheme of Arrangement-II was April 1, 2018 (“**Appointed Date**”). The Scheme of Arrangement-II was authenticated pursuant to the order of the NCLT on April 4, 2019, read with order dated April 15, 2019. In terms of the Scheme of Arrangement-II, the Transferor stood demerged and amalgamated with the Resulting Companies as a going concern, and all assets, liabilities, licences, permits, registrations, contracts, employees, etc., as applicable, stood transferred or deemed to be transferred to and vested in the Resulting Companies. In consideration of the assets, liabilities and undertakings pertaining to the business of operation of showrooms to buy and sell automobiles of a single brand “Honda”, the operation of workshops and garages to repair and service the automobiles of LAPL (“**Demerged Undertaking**”) being transferred to WAPL, our Company issued and allotted 27,678 equity shares of our Company of ₹10 each for every 10,000 equity shares of LAPL of ₹10 each. Further, in consideration of the assets, liabilities and undertakings pertaining to the group investment business (“**Residual Business**”) of LAPL being transferred to our Company, our Company issued and allotted 7,704 equity shares of our Company of ₹10 each for every 10,000 equity shares of LAPL of ₹10 each. Pursuant to the Scheme of Arrangement - II, LAPL stood dissolved without being wound-up and its name was struck-off from the records of the relevant registrar of companies. Upon sanctioning of the Scheme of Arrangement – II, the name of WAPL was changed to LAPL. For details of such allotment, see “*Capital Structure- Notes to the Capital Structure - Equity share capital history of our Company*” on page 76.

**Composite scheme of arrangement and amalgamation in the nature of demerger and amalgamation between our Company, Landmark Commercial Vehicles Private Limited (“LCVPL/Transferor”) and Watermark Commercial Vehicles Private Limited (“WCVPL”) and their respective shareholders and creditors, approved and sanctioned by the National Company Law Tribunal, Ahmedabad by way of its order dated April 4, 2019, read with order dated April 15, 2019 (“Scheme of Arrangement - III”)**

A composite scheme of arrangement was filed by LCVPL, WCVPL and our Company (together with WCVPL, as the “**Resulting Companies**”) before the National Company Law Tribunal, Ahmedabad Bench (“**NCLT**”), under Sections 230 to 233, and other applicable provisions of the Companies Act, 2013, seeking approval for the composite scheme of arrangement and amalgamation of the Transferor and Resulting Companies. The appointed date for the Scheme of Arrangement-III was October 1, 2018 (“**Appointed Date**”). The Scheme of Arrangement-III was authenticated pursuant to the order of the NCLT on April 4, 2019. In terms of the Scheme of Arrangement-III, the Transferor stood demerged and amalgamated with the Resulting Companies as a going concern, and all assets, liabilities, licences, permits, registrations, contracts, employees, etc., as applicable, stood transferred or deemed to be transferred to and vested in the Resulting Companies. In consideration of the assets, liabilities, and undertakings pertaining to the business of operation of showrooms to buy and sell automobiles of a single brand “Ashok Leyland”, the operation of workshops and garages to repair and service the automobiles of LCVPL (“**Demerged Undertaking**”) being transferred to WCVPL, our Company issued and allotted 4,022 equity shares of our Company of ₹10 each for every 10,000 equity shares of LCVPL of ₹10 each. Further, in consideration of the assets, liabilities and undertakings pertaining to the group investment business (“**Residual Business**”) of LCVPL being transferred to our Company, our Company issued and allotted 14 equity shares of our Company of ₹10 each for every 10,000 equity shares of LCVPL of ₹10 each. Pursuant to the Scheme of Arrangement - II, LAPL stood dissolved without being wound-up and its name was struck-off from the records of the relevant registrar of companies. Upon sanctioning of the Scheme of Arrangement – III, the name of WCVPL was changed to LCVPL. For details of such allotment, see “*Capital Structure- Notes to the Capital Structure - Equity share capital history of our Company*” on page 76.

**Revaluation of assets in the last 10 years**

Our Company has not revalued its assets in the 10 years preceding the date of this Draft Red Herring Prospectus.

**Details of subsisting shareholders agreements**

**Shareholders Agreement dated November 4, 2014, entered into between TPG Growth (“Investor”), Sanjay Karsandas Thakker (“Sponsor 1”), Ami Sanjay Thakker (“Sponsor 2” and collectively along with Sponsor 1, the “Sponsors”) and our Company as amended by the amendment agreements dated January 29, 2016, and September 30, 2018, and the Waiver cum Amendment Agreement dated January 11, 2022.**

The Shareholders Agreement confers certain rights and obligations on the parties and imposes certain restrictions on the transfer of securities. Pursuant to the Shareholders Agreement, the Investor has agreed to *inter alia* subscribe to the 291,083 compulsorily convertible preference shares of our Company, having a face value of ₹10 (“**CCPS**”). The consideration for the issuance of CCPS received from the Investor shall be utilised solely for the working capital and growth requirements of the group companies of our Company. In relation to the management and directorship, the Board of Directors shall include a director who shall be nominated for appointment by the Investor (“**Investor Director**”). The Investor shall also be entitled to appoint one observer on the Board and such observer all be entitled to attend all the Board and committee meetings, receive notices and communications for Investor Director. Our Company will appoint one director nominated by the Investor on the board of directors for each of the group companies of our Company and none of them shall be liable to retire by rotation. Further, pursuant to the amendment agreement dated September 30, 2018, there are certain affirmative rights to the Investor for certain reserved matters, *inter alia* being (a) amending or waiving any provision of the Articles of Association or the Memorandum of Association or changing the rights of any class of shares; (b) issuing, allotting, redeeming, or repurchasing any shares or debt securities including, without limitation, issuing bonus shares, of any group company; (c) incorporating any subsidiary or other body corporate; (d) entering into, modifying or terminating any material contract or arrangement or any contract affecting a material part of the business, which is (i) outside the ordinary course of business; (ii) intended to persist for longer than 12 (twelve) months; (iii) contains any unusual or onerous commitment(s); or (iv) could involve liability to make payments in excess of ₹20 million.

In the event of winding up, all the Equity Shares held by the Investor, shall receive: (i) all amounts invested by the Investor in acquiring the Equity Shares; (ii) the Investor’s relevant proportion, as per the Shareholders Agreement, of all the assets and funds of our Company legally available for distribution to the shareholders, on priority, from the total proceeds from such winding up after discharging or making any provision for discharging the liabilities of our Company.

In the event the amount received by the Investor upon winding up is lesser than the amounts it is entitled to, the Shareholders (other than the Investor) shall be jointly and severally liable to pay the shortfall amount to the Investor, provided that such amount does not exceed the amounts received by the Shareholders as a result of such winding up.

Pursuant to the Waiver cum Amendment Agreement, the Shareholders Agreement shall automatically terminate upon commencement of listing of the Equity Shares on a recognised stock exchange in India, provided that TPG Growth shall have the right to nominate one (1) director on the Board of our Company, until such time that TPG Growth (together with its affiliates) continues to hold at least five percent (5%) of the issued and fully paid-up Equity Share capital of our Company. Provided that such right may be exercised after approval of such right by way of a special resolution by the Shareholders, at a general meeting held post the listing of the Equity Shares.

Pursuant to the Waiver cum Amendment Agreement, TPG Growth has agreed to waive and suspend, *inter alia*, the following rights: (a) information and inspection rights from the date of filing of the Red Herring Prospectus; (b) right to appoint an observer on the Board from the date of the filing of the Red Herring Prospectus; and (c) rights relating to transfer restrictions, right of first refusal, tag-along, pre-emptive rights etc. as required for the Offer from the date of execution of the Waiver cum Amendment Agreement.

Other than the right of the (i) Investor to nominate one (1) Director on our Board (as mentioned above) and (ii) Promoter to elect the Chairman, which will be subject to a special resolution by the Shareholders of our Company, at a general meeting held post listing of the Equity Shares, no special rights available to the Shareholders shall survive the listing of the Equity Shares on the Stock Exchanges pursuant to the Offer.

**Shares Subscription and Shareholders Agreement dated February 14, 2013, entered into between Sanjay Karsandas Thakker, Ami Sanjay Thakker, Landmark Cars (East) Private Limited, Autocity Services Private Limited (“ASPL”), and our Company (“Kolkata Shares Subscription and Shareholders Agreement”)**

The Kolkata Shares Subscription and Shareholders Agreement confers certain rights and obligations on the parties and imposes certain restrictions on the transfer of securities. The Kolkata Shares Subscription and Shareholders Agreement was entered into to record the equity investment made by ASPL in LCPL. Pursuant to the terms of the agreement, ASPL is entitled to certain rights, *inter alia* (i) anti-dilution rights subject to a specified threshold; (ii) dividend rights; (iii) tag along rights; and (iv) drag along rights. Further, both parties have the right of first refusal on any transfers made by the other party.

Pursuant to the Kolkata Shares Subscription and Shareholders Agreement, ASPL agreed to subscribe to 150,000 Class B equity shares of our Company for ₹10 each (“**Class B Equity Shares**”) for a consideration of ₹1.50 million. ASPL is entitled to dividend declared by our Company. The Class B Equity Shares allotted to ASPL are not freely transferable, except as disclosed in the Kolkata Shares Subscription and Shareholders Agreement. Further, ASPL has no voting or participatory rights *inter alia* in the management and operations of our Company.

**Other agreements**

Neither our Promoter nor any of the Key Managerial Personnel, Directors or employees of our Company have entered into an agreement, either by themselves or on behalf of any other person, with any shareholder or any other third party with regard to compensation or profit sharing in connection with dealings in the securities of our Company.

Except as disclosed above, our Company has not entered into any subsisting material agreement, other than in the ordinary course of business.

**Significant financial and/or strategic partners**

Our Company does not have any significant financial and/or strategic partners as of the date of filing this Draft Red Herring Prospectus.

**Details of guarantees given to third parties by the promoter participating in the Offer for Sale**

Our Promoter is not offering any Equity Shares held by him in the Offer for Sale.

## OUR SUBSIDIARIES

As on the date of this Draft Red Herring Prospectus, our Company has seven Subsidiaries, the details of which are set out below:

### 1. *Automark Motors Private Limited (“AMPL”)*

#### *Corporate information*

AMPL was originally incorporated as Watermark Vehicles Private Limited on March 23, 2018, under the Companies Act, 2013. Consequent to the NCLT Order, its name was changed to AMPL and a fresh certificate of incorporation was issued on July 9, 2019. AMPL’s CIN is U50500GJ2018PTC101476 and has its registered office at Landmark House, Opp. AEC, S.G. Highway Thaltej, Near Gurudwara, Ahmedabad Gujarat 380 059, India

#### *Nature of business*

AMPL is currently engaged in the business of buying, selling, marketing, repairing, servicing, maintaining and / or dealing in all kinds of new passenger vehicles (Volkswagen), used passenger vehicles and their spare parts and accessories.

#### *Capital structure*

Particulars	No. of equity shares of face value of ₹10 each
Authorised equity share capital	1,000,000
Issued, subscribed and paid-up equity share capital	1,000,000

#### *Shareholding pattern*

The shareholding pattern of AMPL as on the date of this Draft Red Herring Prospectus is as follows:

S. No.	Name of the shareholder	No. of equity shares held	Face value (₹)	Percentage of total equity share capital (%)
1.	Landmark Cars Limited	990,000	10	99.00
2.	Sanjay Karsandas Thakker on behalf of Landmark Cars Limited	10,000	10	1.00
<b>Total</b>		<b>1,000,000</b>		<b>100.00</b>

### 2. *Landmark Automobiles Private Limited (“LAPL”)*

#### *Corporate information*

LAPL was originally incorporated as Watermark Automobiles Private Limited on March 6, 2018, under the Companies Act, 2013. Consequent to the NCLT Order, its name was changed to LAPL and a fresh certificate of incorporation was issued on July 9, 2019. Its CIN is U50100GJ2018PTC101082 and has its registered office situated at Landmark House, Opp. AEC, Near Gurudwara, Sarkhej Highway, Thaltej Ahmedabad, Gujarat, 380 059 India.

#### *Nature of business*

LAPL is currently engaged in the business of buying, selling, marketing, repairing, servicing, maintaining and / or dealing in all kinds of new passenger vehicles (Honda), used passenger vehicles and their spare parts and accessories.

#### *Capital structure*

Particulars	No. of equity shares of face value of ₹10 each
Authorised equity share capital	1,000,000
Issued, subscribed and paid-up equity share capital	1,000,000

#### *Shareholding Pattern*

The shareholding pattern of LAPL as on the date of this Draft Red Herring Prospectus is as follows:

S. No.	Name of the shareholder	No. of equity shares held	Face value (₹)	Percentage of total equity share capital (%)
1.	Landmark Cars Limited	990,000	10	99.00
2.	Sanjay Karsandas Thakker on behalf of Landmark Cars Limited	10,000	10	1.00
<b>Total</b>		<b>1,000,000</b>		<b>100.00</b>

### 3. Landmark Commercial Vehicles Private Limited (“LCVPL”)

#### Corporate information

LCVPL was initially incorporated as Watermark Commercial Vehicles Private Limited pursuant to a certificate of incorporation dated April 24, 2018. Consequent to the NCLT Order, the name was changed to LCVPL and a fresh certificate of incorporation was issued on July 9, 2019. LCVPL’s CIN is U50500GJ2018PTC102015. Its registered office is situated at Landmark House, Opp. AEC, Near Gurudwara, S.G. Highway Thaltej, Ahmedabad Gujarat 380 059, India.

#### Nature of business

LCVPL is currently engaged in the business of buying, selling, marketing, repairing, servicing, maintaining and/or dealing in all kinds of new commercial vehicles (Ashok Leyland) and their spare parts and accessories.

#### Capital structure

Particulars	No. of equity shares of face value of ₹10 each
Authorised equity share capital	1,000,000
Issued, subscribed and paid-up equity share capital	1,000,000

#### Shareholding Pattern

The shareholding pattern of LCVPL as on the date of this Draft Red Herring Prospectus is as follows:

S. No.	Name of the shareholder	No. of equity shares held	Face value (₹)	Percentage of total equity share capital (%)
1.	Landmark Cars Limited	999,999	10	100.00
2.	Sanjay Karsandas Thakker on behalf of Landmark Cars Limited	1	10	-
<b>Total</b>		<b>1,000,000</b>		<b>100.00</b>

### 4. Landmark Cars (East) Private Limited (“LCEPL”)

#### Corporate information

LCEPL was incorporated on January 10, 2013, under the Companies Act, 1956 as a private limited company. LCEPL’s CIN is U50404GJ2013PTC073332 and has its registered office at Landmark House, Opp. AEC, S.G. Highway Thaltej, Near Gurudwara, Ahmedabad, Gujarat 380 059, India.

#### Nature of business

LCEPL is currently engaged in the business of buying, selling, marketing, repairing, servicing, maintaining and /or dealing in all kinds of new passenger vehicles (Mercedes-Benz), used passenger vehicles and their spare parts and accessories.

#### Capital Structure

Particulars	No. of equity shares of face value of ₹10 each
<b>AUTHORISED EQUITY SHARE CAPITAL</b>	<b>1,000,000</b>
Class A equity shares	850,000



Particulars	No. of equity shares of face value of ₹10 each
Class B equity shares	150,000
<b>ISSUED, SUBSCRIBED AND PAID-UP EQUITY SHARE CAPITAL</b>	<b>1,000,000</b>
Class A equity shares	850,000
Class B equity shares	150,000

### Shareholding Pattern

The shareholding pattern of LCEPL as on the date of this Draft Red Herring Prospectus is as follows:

Sr. No.	Name of the shareholder	No. of equity shares held	Face value (₹)	Percentage of total equity share capital (%)	Percentage of voting rights (%)
1.	Landmark Cars Limited	830,000	10	83.00%	97.65%
2.	Sanjay Karsandas Thakker jointly with Ami Sanjay Thakker	10,000	10	1.00%	1.18%
3.	Ami Sanjay Thakker jointly with Sanjay Karsandas Thakker	10,000	10	1.00%	1.18%
4.	Autocity Services Private Limited	150,000*	10	15.00%	-*
<b>Total</b>		<b>1,000,000</b>		<b>100.00</b>	

\*Shares with no voting rights in accordance with the Kolkata Shares Subscription and Shareholders Agreement.

### 5. Landmark Lifestyle Cars Private Limited (“LLCPL”)

#### Corporate information

LLCPL was incorporated on October 19, 2015, under the Companies Act, 2013, as a private limited company. LLCPL’s CIN is U50500GJ2015PTC084794. Its registered office is situated at Landmark House, Opp. AEC, Near Gurudwara, Thaltej Cross Road, Sarkhej Highway Thaltej, Ahmedabad 380 059, Gujarat, India.

#### Nature of business

LLCPL is currently engaged in the business of buying, selling, marketing, repairing, servicing, maintaining and /or dealing in all kinds of new passenger vehicles (Jeep), their spare parts and accessories and used passenger vehicles.

#### Capital structure

Particulars	No. of shares of face value of ₹10 each
<b>AUTHORISED SHARE CAPITAL</b>	<b>21,300,000</b>
Equity share capital	6,000,000
Preference share capital	15,300,000
<b>ISSUED, SUBSCRIBED AND PAID-UP SHARE CAPITAL</b>	<b>21,000,000</b>
Equity share capital	6,000,000
Preference share capital	15,000,000

#### Shareholding pattern

The equity shareholding pattern of LLCPL as on the date of this Draft Red Herring Prospectus is as follows:

S. No.	Name of the shareholder	No. of equity shares held	Face value (₹)	Percentage of total equity share capital (%)
1.	Landmark Cars Limited	5,999,999	10	100.00
2.	Sanjay Karsandas Thakker as a nominee of Landmark Cars Limited	1	10	-
<b>Total</b>		<b>6,000,000</b>		<b>100.00</b>

The preference shareholding pattern of LLCPL as on the date of this Draft Red Herring Prospectus is as follows:

S. No.	Name of the shareholder	No. of non-convertible non-cumulative redeemable preference shares	Face Value (₹)	Percentage of total preference share capital (%)
1.	Landmark Cars Limited	15,000,000	10	100%

#### 6. Benchmark Motors Private Limited (“BMPL”)

##### Corporate information

BMPL was incorporated on October 14, 2016, under the Companies Act, 2013 as a private limited company. Its CIN is U50400GJ2016PTC094085 and its registered office is situated at Landmark House, Opp. AEC, Near Gurudwara, Thaltej Cross Road, Sarkhej Highway, Thaltej, Ahmedabad Gujarat 380 059, India.

##### Nature of business

BMPL is currently engaged in the business of buying, selling, marketing, repairing, servicing, maintaining and / or dealing in all kinds of new passenger vehicles (Renault), used passenger vehicles and their spare parts and accessories.

##### Capital structure

Particulars	No. of shares of face value of ₹10 each
<b>AUTHORISED SHARE CAPITAL</b>	<b>44,300,000</b>
Equity share capital	11,000,000
Preference share capital	33,300,000
<b>ISSUED, SUBSCRIBED AND PAID-UP SHARE CAPITAL</b>	<b>44,000,000</b>
Equity share capital	11,000,000
Preference share capital	33,000,000

##### Shareholding pattern

The equity shareholding pattern of BMPL as on the date of this Draft Red Herring Prospectus is as follows:

Sr. No.	Name of the shareholder	No. of equity shares held	Face Value (₹)	Percentage of total equity share capital (%)
1.	Landmark Cars Limited	10,999,999	10	100.00
2.	Sanjay Karsandas Thakker as a nominee of Landmark Cars Limited	1	10	-
<b>Total</b>		<b>11,000,000</b>		<b>100.00</b>

The preference shareholding pattern of BMPL as on the date of this Draft Red Herring Prospectus is as follows:

Sr. No.	Name of the shareholder	No. of non-convertible non-cumulative redeemable preference shares	Face Value (₹)	Percentage of total preference share capital (%)
1.	Landmark Cars Limited (RPS1)	25,000,000	10	75.76
2.	Landmark Cars Limited (RPS2)	8,000,000	10	24.24
<b>Total</b>		<b>33,000,000</b>		<b>100.00</b>

#### 7. Watermark Cars Private Limited (“WCPL”)

##### Corporate information

WCPL was incorporated on November 16, 2016, under the Companies Act, 2013 as a private limited company. Its CIN is U50500GJ2016PTC094392. Its registered office is situated at Landmark House, Opp. AEC, Near Gurudwara, Thaltej Cross Road, Sarkhej Highway, Thaltej, Ahmedabad, Gujarat 380 059, India.

### *Nature of business*

WCPL is currently engaged in the business of BYD brand passenger cars for Delhi and Mumbai location, sale of vehicle accessories and business of shared services.

### *Capital structure*

Particulars	No. of shares of face value of ₹10 each
<b>AUTHORISED SHARE CAPITAL</b>	<b>23,000,000</b>
Equity share capital	20,000,000
Preference share capital	3,000,000
<b>ISSUED, SUBSCRIBED AND PAID-UP SHARE CAPITAL</b>	<b>4,000,000</b>
Equity share capital	1,000,000
Preference share capital	3,000,000

### *Shareholding pattern*

The equity shareholding pattern of WCPL as on the date of this Draft Red Herring Prospectus is as follows:

Sr. No.	Name of the shareholder	No. of equity shares held	Face Value (₹)	Percentage of total equity share capital (%)
1.	Landmark Cars Limited	999,950	10	99.99
2.	Sanjay Karsandas Thakker as a nominee of Landmark Cars Limited	50	10	0.01
<b>Total</b>		<b>1,000,000</b>		<b>100.00</b>

The preference shareholding pattern of WCPL as on the date of this Draft Red Herring Prospectus is as follows:

Sr. No.	Name of the shareholder	No. of non-convertible non-cumulative redeemable preference shares	Face Value (₹)	Percentage of total preference share capital (%)
1.	Landmark Cars Limited	3,000,000	10	100.00

### **Accumulated profits or losses**

As on the date of this Draft Red Herring Prospectus, there are no accumulated profits or losses of our Subsidiaries that have not been accounted for or consolidated by our Company.

### **Common Pursuits**

All our Subsidiaries are in the same line of business as that of our Company. Our Company will adopt necessary procedures and practices as permitted by law and regulatory guidelines to address any conflict situations if they arise.

### **Related business transactions**

Except as disclosed in “*Restated Consolidated Financial Information*” on page 202, there have been no related business transactions of our Subsidiaries with our Company during the six months ended September 30, 2021 and the last three Fiscals.

### **Interest in our Company**

Except as disclosed in “*Our Business*” on page 133, as on the date of this Draft Red Herring Prospectus, the Subsidiaries do not have any business interest in our Company.

### **Other confirmations**

None of our Subsidiaries are listed on any stock exchange in India or abroad. Further, neither have any of the securities of our Subsidiaries been refused listing by any stock exchange in India or abroad, nor have any of our Subsidiaries failed to meet the listing requirements of any stock exchange in India or abroad.

## OUR MANAGEMENT

### Board of Directors

As on the date of this Draft Red Herring Prospectus, we have eight Directors on our Board, of whom four are Independent Directors, including one-woman Independent Director. Our Company is in compliance with the corporate governance laws prescribed under the SEBI Listing Regulations and the Companies Act, 2013, in relation to the composition of our Board and constitution of committees thereof.

The following table sets forth the details of our Board as on the date of this Draft Red Herring Prospectus:

Name, designation, date of birth, address, occupation, current term, period of directorship and DIN	Age (years)	Other directorships
<p><b>Sanjay Karsandas Thakker</b></p> <p><i>Designation:</i> Chairman and Executive Director</p> <p><i>Date of birth:</i> November 20, 1965</p> <p><i>Address:</i> 10, Laxmi Nivas, Near Gamdevi Police Station 22, Kashibai Navrange Marg, Gamdevi Grant Road S.O, Mumbai 400 007, Maharashtra</p> <p><i>Occupation:</i> Business</p> <p><i>Current term:</i> Three years with effect from October 28, 2021 till October 27, 2024. Not liable to retire by rotation.</p> <p><i>Period of directorship:</i> Since February 23, 2006</p> <p><i>DIN:</i> 00156093</p>	56	<ul style="list-style-type: none"> <li>• Automark Motors Private Limited;</li> <li>• Benchmark Motors Private Limited;</li> <li>• Ekta Housemakers Private Limited;</li> <li>• Kamlesh Real Estates Private Limited;</li> <li>• Landmark Automobiles Private Limited;</li> <li>• Landmark Cars (East) Private Limited;</li> <li>• Landmark Commercial Vehicles Private Limited;</li> <li>• Landmark Insurance Brokers Private Limited;</li> <li>• Landmark Lifestyle Cars Private Limited;</li> <li>• Landmark Pre-Owned Cars Private Limited;</li> <li>• Sewri Land Company Private Limited;</li> <li>• Watermark Cars Private Limited;</li> <li>• Wild Dreams Media and Communications Private Limited; and</li> <li>• Wild Dreams Trading Company Private Limited</li> </ul>
<p><b>Aryaman Sanjay Thakker</b></p> <p><i>Designation:</i> Executive Director</p> <p><i>Date of birth:</i> September 8, 1992</p> <p><i>Address:</i> 10, Laxmi Nivas, Near Gamdevi Police Station 22, Kashibai Navrange Marg, Gamdevi Grant Road S.O, Mumbai 400 007, Maharashtra</p> <p><i>Occupation:</i> Employment</p> <p><i>Current term:</i> Three years with effect from October 28, 2021 till October 27, 2024. Liable to retire by rotation.</p> <p><i>Period of directorship:</i> Since December 10, 2020</p> <p><i>DIN:</i> 07625409</p>	29	<ul style="list-style-type: none"> <li>• Interstellar Services Private Limited;</li> <li>• Landmark Cars (East) Private Limited; and</li> <li>• Landmark Commercial Vehicles Private Limited</li> </ul>
<p><b>Paras Somani</b></p> <p><i>Designation:</i> Executive Whole-Time Director</p>	48	<ul style="list-style-type: none"> <li>• Landmark Cars (East) Private Limited; and</li> <li>• Landmark Pre-Owned Cars Private Limited</li> </ul>

Name, designation, date of birth, address, occupation, current term, period of directorship and DIN	Age (years)	Other directorships
<p><i>Date of birth:</i> November 21, 1973</p> <p><i>Address:</i> 702, Eminence-14, Zydus Hospital Road, Near Baghban Party Plot, Opp. Thaltej Fire Station, Thaltej, Ahmedabad 380 059, Gujarat</p> <p><i>Occupation:</i> Employment</p> <p><i>Current term:</i> Three years with effect from October 28, 2021 till October 27, 2024. Liable to retire by rotation</p> <p><i>Period of directorship:</i> Since October 24, 2009</p> <p><i>DIN:</i> 02742256</p>		
<p><b>Akshay Tanna</b></p> <p><i>Designation:</i> Nominee Director of TPG Growth</p> <p><i>Date of birth:</i> November 20, 1982</p> <p><i>Address:</i> A/72, Darshan Apartments, Mount Pleasant Road, Malabar Hill, Near Chief Minister's Bungalow, Mumbai 400 006, Maharashtra</p> <p><i>Occupation:</i> Business</p> <p><i>Current term:</i> Liable to retire by rotation.</p> <p><i>Period of directorship:</i> Since December 10, 2020</p> <p><i>DIN:</i> 02967021</p>	39	<ul style="list-style-type: none"> <li>• Big Tree Entertainment Private Limited;</li> <li>• Brainbees Solutions Private Limited;</li> <li>• Dodla Dairy Limited;</li> <li>• Lakeside Dairy Limited;</li> <li>• Landmark Insurance Brokers Private Limited;</li> <li>• Livspace Pte. Ltd;</li> <li>• SK Finance Limited; and</li> <li>• Swastik Hospitality Products Private Limited</li> </ul>
<p><b>Manish Balkishan Chokhani</b></p> <p><i>Designation:</i> Independent Director</p> <p><i>Date of birth:</i> October 14, 1966</p> <p><i>Address:</i> 161, Silver Arch, 66, L Jagmohandas Marg, Near Petit Hall Compound, Nepean Sea Road, Malabar Hill, Mumbai 400 006</p> <p><i>Occupation:</i> Business</p> <p><i>Current term:</i> For a period of five years, with effect from October 28, 2021. Not liable to retire by rotation.</p> <p><i>Period of directorship:</i> Since October 28, 2021</p>	55	<ul style="list-style-type: none"> <li>• Auxilo Finserve Private Limited;</li> <li>• Laxmi Organic Industries Limited;</li> <li>• Livinguard A.G.</li> <li>• Quadrillion Capital Private Limited;</li> <li>• Sears Securities and Investments Private Limited;</li> <li>• Shoppers Stop Limited; and</li> <li>• Westlife Development Limited</li> </ul>

Name, designation, date of birth, address, occupation, current term, period of directorship and DIN	Age (years)	Other directorships
<i>DIN:</i> 00204011		
<p><b>Gautam Yogendra Trivedi</b></p> <p><i>Designation:</i> Independent Director</p> <p><i>Date of birth:</i> January 24, 1966</p> <p><i>Address:</i> 7<sup>th</sup> Floor, Mistry Manor, 62-A Nepean Sea Road, Near Priyadarshini Park, Malabar Hill, Mumbai 400 006, India</p> <p><i>Occupation:</i> Investment Manager</p> <p><i>Current term:</i> For a period of five years, with effect from October 28, 2021. Not liable to retire by rotation.</p> <p><i>Period of directorship:</i> Since October 28, 2021</p> <p><i>DIN:</i> 02647162</p>	55	<ul style="list-style-type: none"> <li>• Anaheim Trading Private Limited;</li> <li>• Extramarks Education India Private Limited;</li> <li>• Landmark Automobiles Private Limited;</li> <li>• Raymond Apparel Limited;</li> <li>• Trivedi Consultants Private Limited; and</li> <li>• UFO Moviez India Limited</li> </ul>
<p><b>Sucheta Nilesh Shah</b></p> <p><i>Designation:</i> Independent Director</p> <p><i>Date of birth:</i> August 31, 1966</p> <p><i>Address:</i> 90/2, Neeta Building, G Road, Marine Drive, Kalbadevi, Mumbai 400 002, Maharashtra, India</p> <p><i>Occupation:</i> Business in Financial services</p> <p><i>Current term:</i> For a period of five years, with effect from October 28, 2021. Not liable to retire by rotation</p> <p><i>Period of directorship:</i> Since October 28, 2021</p> <p><i>DIN:</i> 00322403</p>	55	<ul style="list-style-type: none"> <li>• Atlas Integrated Finance Limited;</li> <li>• Atlas Wealth Management Private Limited;</li> <li>• Automark Motors Private Limited;</li> <li>• IHSEDU Agrochem Private Limited;</li> <li>• Jayant Agro-Organics Limited; and</li> <li>• The Indian Hume Pipe Company Limited.</li> </ul>
<p><b>Ramakant Sharma</b></p> <p><i>Designation:</i> Independent Director</p> <p><i>Date of birth:</i> December 12, 1979</p> <p><i>Address:</i> B404, Knightsbridge Apartments, Brookefields, CMR IT College, Kundalahalli, Bangalore North, Bangalore, Marathahalli Colony, Karnataka, 560 037</p> <p><i>Occupation:</i> Business</p>	42	<ul style="list-style-type: none"> <li>• API Holdings Private Limited;</li> <li>• Home Interior Designs E-Commerce Private Limited;</li> <li>• Lambda Test INC.;</li> <li>• Livspace Pte. Ltd.;</li> <li>• Pay later Partners Pte. Ltd.; and</li> <li>• Workspace Business Services Private Limited.</li> </ul>

Name, designation, date of birth, address, occupation, current term, period of directorship and DIN	Age (years)	Other directorships
<p><i>Current term:</i> For a period of five years, with effect from October 28, 2021. Not liable to retire by rotation.</p> <p><i>Period of directorship:</i> Since October 28, 2021</p> <p><i>DIN:</i> 02318054</p>		

### Brief profiles of our Directors

**Sanjay Karsandas Thakker** is the Chairman and Executive Director of our Company. He has a bachelor's degree in commerce from Sydenham College of Commerce and Economics, University of Bombay. He founded the Group Landmark in 1998. He has more than two decades of experience in the automobile industry. He was awarded with the title of 'Business Leader of the Year' at the 19<sup>th</sup> global edition and 4<sup>th</sup> Indian edition of the Business Leader of the Year Awards presented by World Leadership Congress and Awards on February 17, 2021.

**Aryaman Sanjay Thakker** is an Executive Director of our Company. He has a bachelor's degree in business administration from the Bharati Vidyapeeth Deemed University, Pune and has a master's degree of science in marketing and strategy from the University of Warwick. He joined Group Landmark in 2017 as a General Manager of LAPL.

**Paras Somani** is an Executive Whole-Time Director of our Company. He has a bachelor's degree in commerce from the Saurashtra University and has also participated in the ISBCEO Leadership Programme by the Indian School of Business, Hyderabad from July 2017 to August 2018. He joined Group Landmark in 2006 as the Vice President- Sales in LAPL and currently leads the Mercedes-Benz and Volkswagen business. in Group Landmark. He has over two decades of experience in sales and banking. He was previously associated with Kotak Mahindra Primus Limited.

**Akshay Tanna** is the Nominee Director of TPG Growth. He has a bachelor's degree of science in economics from University of Pennsylvania. He has over a decade of experience in private equity and investment banking and is one of the winners of Economic Times '40 Under Forty' - 2020 edition. He has been employed with TPG Capital India Private Limited since 2011 and is currently a partner at TPG Growth & Rise Fund.

**Manish Balkishan Chokhani**, is an Independent Director of our Company. He holds a masters' degree in business administration from London Business School, University of London. He is an associate of the Institute of Chartered Accountants of India and has been admitted as a fellow of the All-India Management Association. Prior to joining the Company, he was the director of Enam Securities Private Limited from 2006 to 2019. He has in the past served as the managing director and chief executive officer of Axis Capital Limited. He served as chairman of TPG Growth India during the period of 2015-2016 and as a senior advisor to TPG Growth during 2013 to 2019. He also serves on the governing board of Flame University. He is a member of the Young Presidents' Organization, Inc. He has also served as a member of the SEBI's Alternative Investment Policy Advisory Committee.

**Gautam Yogendra Trivedi** is an Independent Director of our Company. He holds a bachelors' degree in Commerce from Sydenham College of Commerce and Economics, University of Bombay and a bachelor's degree in law from Government Law College, University of Bombay and a master's degree in business administration from University of Southern California, Los Angeles. He has served as a vice president – new businesses at Reliance Industries Limited. He has also served as the managing director and head of equities, India at Religare Capital Markets Limited and as an executive director in the Asia Pacific Shares department of the equities division at Goldman Sachs (Asia) LLC. He has been previously associated with DSP Financial Consultants Limited, Credit Lyonnais Securities India Private Limited and Jardine Fleming Holdings Limited. He is also the co-founder and managing partner of Nepean Capital LLP since June 1, 2017.

**Sucheta Nilesh Shah** is an Independent Director of our Company. She holds a bachelors' degree in commerce from Sydenham College of Commerce and Economics and has completed her master's in management studies from S P Jain Institute of Management and Research, University of Bombay. She is the Executive director of Atlas Integrated Finance Limited. She was the Chairperson of FICCI Maharashtra, MSME Committee, during FY 18-19 and FY 19-20. She was the Chairperson of the FLO Mumbai Chapter for the year 2011-12 and was the National Head for SWAYAM, a support cell for women entrepreneurs, an initiative by FICCI FLO from the year 2015 to 2018. She has been the director of Grameen Initiative for Women. She was also a director of TATA Housing Development Company Limited.

**Ramakant Sharma** is an Independent Director of our Company. He holds a bachelor's degree in technology in materials and metallurgical engineering from Indian Institute of Technology, Kanpur and has completed post graduate programme in management from the Indian School of Business, Hyderabad. He has over 10 years of experience in engineering and management roles and has been in the past associated with Zapak Digital Entertainment Limited, GE Medical Systems (India) Private Limited, Ketera Software India Private Limited, Myntra Designs Private Limited and Livespace.com (Home Interior Designs E-commerce Private Limited).

### **Relationship between our Directors**

None of our Directors are related to each other, except Aryaman Sanjay Thakker who is the son of Sanjay Karsandas Thakker.

### **Confirmations**

None of our Directors is or was a director of any company listed on any stock exchange, whose shares have been or were suspended from being traded during the five years preceding the date of this Draft Red Herring Prospectus, during the term of his/her directorship in such company.

None of our Directors is, or was a director of any listed company, which has been or was delisted from any stock exchange, during the term of his/her directorship in such company.

No consideration, either in cash or shares or in any other form have been paid or agreed to be paid to any of our Directors or to the firms, trusts or companies in which they have an interest in, by any person, either to induce any of our Directors to become or to help any of them qualify as a director, or otherwise for services rendered by them or by the firm, trust or company in which they are interested, in connection with the promotion or formation of our Company.

### **Arrangement or understanding with major Shareholders, customers, suppliers, or others**

Except for our Investor Director, Akshay Tanna, who has been nominated to our Board by TPG Growth, pursuant to the Shareholders Agreement, none of our Directors have been appointed pursuant to any arrangement or understanding with our major Shareholders, customers, suppliers or others.

### **Service contracts with Directors**

Our Company has not entered into any service contracts with any Director, which provide for benefits upon termination of employment.

### **Terms of appointment of our Executive Directors**

#### ***Sanjay Karsandas Thakker, Chairman and Executive Director***

Our Board at their meeting held on October 28, 2021 approved the appointment of Sanjay Karsandas Thakker as Chairman and Executive Director for a period of three years with effect from October 28, 2021. Our Shareholders have approved such appointment at the extra-ordinary general meeting held on November 10, 2021 with a remuneration of ₹ 15.00 million per annum.

#### ***Aryaman Sanjay Thakker, Executive Director***

Our Board at their meeting held on October 28, 2021 approved the appointment of Aryaman Sanjay Thakker as Executive Director for a period of three years with effect from October 28, 2021. Our Shareholders have approved such appointment at the extra-ordinary general meeting held on November 10, 2021 with a remuneration of ₹ 7.50 million per annum.

#### ***Paras Somani, Executive Whole-Time Director***

Our Board at their meeting held on October 28, 2021 approved the appointment of Paras Somani as the Executive Whole-Time Director for a period of three years with effect from October 28, 2021. Our Shareholders have approved such appointment at the extra-ordinary general meeting held on November 10, 2021 with a remuneration of a minimum of ₹ 11.00 million per annum.



## Terms of appointment of our Independent Directors

Pursuant to their appointment letters with the Company, the sitting fees payable to our Independent Directors is ₹ 0.10 million per meeting of the Board, ₹ 0.02 million per committee meeting and ₹ 0.05 million per meeting of the board of directors of the Subsidiaries, within the limits prescribed under the Companies Act, 2013, and the rules notified thereunder. Additionally, each Independent Director is also entitled to reimbursement of expenses such as travel, accommodation and other incidental expenses incurred in the performance of their duties, as stipulated in their terms of appointment.

## Payment of benefits to Directors

Our Company has not entered into any contract appointing or fixing the remuneration of a Director in the two years preceding the date of this Draft Red Herring Prospectus.

Except as disclosed below, our Company has not paid any compensation or granted any benefit on an individual basis to any of our Directors (including contingent or deferred compensation) other than the remuneration paid to them in Fiscal 2021.

Our Executive Directors, Sanjay Karsandas Thakker, Aryaman Sanjay Thakker and Paras Somani receive benefits *inter alia* vehicles for official use.

The remuneration paid to our Directors in Fiscal 2021 is as follows:

### 1. Executive Directors

The details of the remuneration paid to our Executive Directors in Fiscal 2021 is set out below:

<i>(in ₹ million)</i>		
Name of Director	Designation	Remuneration from Company
Sanjay Karsandas Thakker	Chairman and Executive Director	7.49
Aryaman Sanjay Thakker	Executive Director	2.00
Paras Somani	Executive Whole-Time Director	6.13

### 2. Independent Directors

All our Independent Directors were appointed during the current Fiscal i.e., Fiscal 2022. Accordingly, no remuneration was paid to them in Fiscal 2021.

### 3. Investor Director

No remuneration was paid by us to the Investor Director in Fiscal 2021.

### 4. Remuneration paid or payable by our Subsidiaries

Except our Executive Whole-Time Director, Paras Somani, none of our Directors were paid any remuneration by our Subsidiaries in Fiscal 2021.

<i>(in ₹ million)</i>		
Name of Director	Designation	Remuneration from LCEPL
Paras Somani	Executive Whole-Time Director	2.03

## Shareholding of Directors in our Company

Our Articles of Association do not require our Directors to hold qualification shares.

The table below sets forth details of Equity Shares held by the Directors, as on date of this Draft Red Herring Prospectus:

Sr. No.	Name of the Director	Number of Equity Shares held
1.	Sanjay Karsandas Thakker (jointly with Ami Sanjay Thakker)	15,154,768
2.	Aryaman Sanjay Thakker (jointly with Sanjay Karsandas Thakker)	565,040

## **Borrowing Powers**

Pursuant to our Articles of Association, subject to applicable provisions of the Companies Act, 2013, and the resolution passed by our Shareholders in their general meeting held on November 10, 2021, our Board has been authorized to borrow any sum or sums of money(ies) from time to time, at its discretion, provided that the total amount so borrowed together with the monies already borrowed by our Company (apart from temporary loans obtained from our Company's bankers in the ordinary course of business) by the Board shall not at any time exceed ₹ 5,000 million over and above the aggregate of the paid up share capital, free reserves and the securities premium of our Company

## **Bonus or profit-sharing plan for our Directors**

Except for the performance linked bonus payable to our Executive Whole -Time Director, for the Financial Year 2021-22, none of our Directors are party to any bonus or profit-sharing plan of our Company.

## **Loans to Directors**

Our Company and Subsidiaries have not provided any loan to our Directors.

## **Interest of Directors**

All our Independent Directors may be deemed to be interested to the extent of sitting fees payable to them for attending meetings of our Board and/or committees thereof as approved by our Board, the reimbursement of expenses payable to them as approved by our Board.

Our Executive Directors may be deemed to be interested to the extent of the remuneration payable to each of them by our Company as Directors of our Company.

Our Executive-Whole Time Director may be interested to the extent of remuneration payable to him by our Subsidiary, LCEPL, pursuant to being on the board of directors of LCEPL.

All the Directors may be deemed to be interested in the contracts, agreements/arrangements entered into or to be entered into by our Company with any company which is promoted by them or in which they hold directorships or any partnership firm in which they are partners.

Our Executive Directors may also be interested to the extent of their shareholding in our Company and to the extent of any dividend payable to them and other distributions in respect of such shareholding. Our Executive-Whole Time Director may also be interested to the extent of options granted to him under the ESOP Scheme.

### *Interest of Directors in the promotion or formation of our Company*

Except for Sanjay Karsandas Thakker, our Promoter, as on the date of this Draft Red Herring Prospectus, none of our Directors have any interest in the promotion or formation of our Company.

Our Directors do not have any interest in any property acquired or proposed to be acquired of or by our Company.

Further, our Directors do not have any interest in any transaction by our Company for acquisition of land, construction of building or supply of machinery during the three years preceding the date of this Draft Red Herring Prospectus.

## **Changes to our Board in the last three years**

<b>Name</b>	<b>Date of change</b>	<b>Designation (at the time of change)</b>	<b>Reason</b>
Mayank Bajpai	December 10, 2020	Non-executive director	Resignation
Akshay Tanna	December 10, 2020	Additional director	Appointment*
Aryaman Sanjay Thakker	December 10, 2020	Additional director	Appointment*
Ami Sanjay Thakker	October 28, 2021	Non-executive director	Resignation
Akshay Tanna	October 28, 2021	Nominee Director of TPG Growth	Change in designation
Aryaman Sanjay Thakker	October 28, 2021	Executive Director	Change in designation
Sanjay Karsandas Thakker	October 28, 2021	Chairman and Executive Director	Change in designation
Paras Somani	October 28, 2021	Executive Whole-Time Director	Change in designation
Manish Balkishan Chokhani	October 28, 2021	Additional independent director	Appointment**

Name	Date of change	Designation (at the time of change)	Reason
Gautam Yogendra Trivedi	October 28, 2021	Additional independent director	Appointment**
Sucheta Nilesh Shah	October 28, 2021	Additional independent director	Appointment**
Ramakant Sharma	October 28, 2021	Additional independent director	Appointment**

\*Akshay Tanna and Aryaman Sanjay Thakker were originally appointed as additional directors by our Board with effect from December 10, 2020. Subsequently, their appointments were regularized pursuant to a resolution of our Shareholders on December 31, 2020.

\*\*Manish Balkishan Chokhani, Gautam Yogendra Trivedi, Sucheta Nilesh Shah and Ramakant Sharma were originally appointed as additional independent directors by our Board with effect from October 28, 2021. Subsequently, their appointments were regularized pursuant to a resolution of our Shareholders on November 10, 2021.

## Corporate Governance

The provisions of the Companies Act, 2013 along with the SEBI Listing Regulations, with respect to corporate governance, will be applicable to our Company immediately upon the listing of the Equity Shares on the Stock Exchanges.

Our Company and Material Subsidiaries are in compliance with the requirements of the applicable regulations in respect of corporate governance in accordance with the SEBI Listing Regulations, and the Companies Act, 2013, pertaining to the composition of the Board and constitution of the committees thereof.

As on the date of filing this Draft Red Herring Prospectus, we have eight Directors on our Board, of whom four are Independent Directors, including one woman Independent Director.

Our Company undertakes to take all necessary steps to continue to comply with all the requirements of the SEBI Listing Regulations and the Companies Act, 2013.

## Committees of our Board

In terms of the SEBI Listing Regulations and the provisions of the Companies Act, 2013, our Company has constituted the following Board-level committees:

1. Audit Committee;
2. Nomination and Remuneration Committee;
3. Stakeholders' Relationship Committee;
4. Corporate Social Responsibility Committee; and
5. Risk Management Committee

### 1. *Audit Committee*

The Audit Committee was constituted by a resolution of our Board dated October 28, 2021. The current constitution of the Audit Committee is as follows:

Name of Director	Position in the Committee	Designation
Sucheta Nilesh Shah	Chairman	Independent Director
Gautam Yogendra Trivedi	Member	Independent Director
Paras Somani	Member	Executive Whole -Time Director

(i) The Audit Committee shall have powers, which shall be as under:

- (a) To investigate any activity within its terms of reference;
- (b) To seek information that it properly requires from any employee of the Company or any associate or subsidiary, joint venture Company in order to perform its duties and all employees are directed by the Board to co-operate with any request made by the Committee from any employee of the Company;
- (c) To obtain outside legal or other professional advice;
- (d) To secure attendance of outsiders with relevant expertise, if it considers necessary and to seek their advice, whenever required; and

(e) Perform such powers as may be prescribed under the Companies Act and SEBI Listing Regulations.

(ii) The role of the Audit Committee shall be as under:

- (a) Oversight of the Company's financial reporting process, examination of the financial statement and the auditors' report thereon and the disclosure of its financial information to ensure that the financial statement is correct, sufficient, and credible;
- (b) Monitoring the end use of funds raised through public offers and related matters;
- (c) Recommendation for appointment, re-appointment and replacement, remuneration and terms of appointment of auditors, including the internal auditor, cost auditor and statutory auditor, of the Company and the fixation of audit fee;
- (d) Approval of payments to statutory auditors for any other services rendered by the statutory auditors of the Company;
- (e) Reviewing, with the management, the annual financial statements and auditor's report thereon before submission to the Board for approval, with particular reference to:
  - i. Matters required to be included in the Director's Responsibility Statement to be included in the Board's report in terms of clause (c) of sub-section 3 of section 134 of the Companies Act;
  - ii. Changes, if any, in accounting policies and practices and reasons for the same;
  - iii. Major accounting entries involving estimates based on the exercise of judgment by the management of the Company;
  - iv. Significant adjustments made in the financial statements arising out of audit findings;
  - v. Compliance with listing and other legal requirements relating to financial statements;
  - vi. Disclosure of any related party transactions; and
  - vii. Qualifications/modified opinion(s) in the draft audit report.
- (f) Reviewing, with the management, the quarterly, half yearly and annual financial statements before submission to the board for approval;
- (g) Reviewing, with the management, the statement of uses/application of funds raised through an issue (public issue, rights issue, preferential issue, etc.), the statement of funds utilised for purposes other than those stated in the offer document/prospectus/notice and the report submitted by the monitoring agency monitoring the utilisation of proceeds of a public or rights issue, and making appropriate recommendations to the Board to take up steps in this matter;
- (h) Reviewing and monitoring the auditor's independence and performance, and effectiveness of audit process;
- (i) Formulating a policy on related party transactions, which shall include materiality of related party transactions;
- (j) Approval or any subsequent modification of transactions of the Company with related parties and omnibus approval for related party transactions proposed to be entered into by the Company subject to such conditions as may be prescribed;
- (k) Review, at least on a quarterly basis, the details of related party transactions entered into by the Company pursuant to each of the omnibus approvals given;
- (l) Scrutiny of inter-corporate loans and investments;
- (m) Valuation of undertakings or assets of the company, wherever it is necessary;
- (n) Evaluation of internal financial controls and risk management systems;

- (o) Reviewing, with the management, performance of statutory and internal auditors, adequacy of the internal control systems;
  - (p) Reviewing the adequacy of internal audit function, if any, including the structure of the internal audit department, staffing and seniority of the official heading the department, reporting structure coverage and frequency of internal audit;
  - (q) Discussion with internal auditors of any significant findings and follow up there on;
  - (r) Reviewing the findings of any internal investigations by the internal auditors into matters where there is suspected fraud or irregularity or a failure of internal control systems of a material nature and reporting the matter to the Board;
  - (s) Discussion with statutory auditors before the audit commences, about the nature and scope of audit as well as post-audit discussion to ascertain any area of concern;
  - (t) Looking into the reasons for substantial defaults in the payment to the depositors, debenture holders, shareholders (in case of non-payment of declared dividends) and creditors;
  - (u) Recommending to the board of directors the appointment and removal of the external auditor, fixation of audit fees and approval for payment for any other services;
  - (v) Reviewing the functioning of the whistle blower mechanism;
  - (w) Approval of the appointment of the Chief Financial Officer of the Company (i.e., the whole-time finance director or any other person heading the finance function or discharging that function) after assessing the qualifications, experience, and background, etc., of the candidate;
  - (x) Carrying out any other functions as provided under the provisions of the Companies Act, the SEBI Listing Regulations and other applicable laws;
  - (y) To formulate, review and make recommendations to the Board to amend the Audit Committee charter from time to time;
  - (z) Establishing a vigil mechanism for directors and employees to report their genuine concerns or grievances;
  - (aa) Carrying out any other function as is mentioned in the terms of reference of the Audit Committee;
  - (bb) Reviewing the utilization of loans and/or advances from/investment by the holding company in the subsidiary exceeding rupees 100 crore or 10% of the asset size of the subsidiary, whichever is lower including existing loans / advances / investments existing as on the date of coming into force of this provision;
  - (cc) Considering and commenting on rationale, cost-benefits and impact of schemes involving merger, demerger, amalgamation etc., on the listed entity and its shareholders; and
  - (dd) Such roles as may be prescribed under the Companies Act and SEBI Listing Regulations.
- (iii) The Audit Committee shall mandatorily review the following information:
- (a) Management discussion and analysis of financial condition and results of operations;
  - (b) Statement of significant related party transactions (as defined by the Audit Committee), submitted by the management of the Company;
  - (c) Management letters/letters of internal control weaknesses issued by the statutory auditors of the Company;
  - (d) Internal audit reports relating to internal control weaknesses;
  - (e) The appointment, removal, and terms of remuneration of the chief internal auditor shall be subject to review

by the Audit Committee;

(f) Statement of deviations:

- i. quarterly statement of deviation(s) including report of monitoring agency, if applicable, submitted to stock exchange(s) in terms of Regulation 32(1) of the SEBI Listing Regulations;
- ii. annual statement of funds utilised for purposes other than those stated in the offer document/prospectus/notice in terms of Regulation 32(7) of the SEBI Listing Regulations; and
- iii. review the financial statements, in particular, the investments made by any unlisted subsidiary.

(iv) To carry out such other functions as may be specifically referred to the Committee by the Board of Directors and/or other Committees of Directors of the Company; and

(v) To make available its terms of reference and review periodically those terms of reference and its own effectiveness and recommend any necessary changes to the Board.

## 2. ***Nomination and Remuneration Committee (“NRC”)***

The NRC was constituted by a resolution of our Board dated October 28, 2021. The current constitution of the NRC is as follows:

<b>Name of Director</b>	<b>Position in the Committee</b>	<b>Designation</b>
Gautam Yogendra Trivedi	Chairman	Independent Director
Sucheta Nilesh Shah	Member	Independent Director
Akshay Tanna	Member	Nominee Director of TPG Growth

The scope and function of the NRC is in accordance with Section 178 of the Companies Act, 2013 read with Regulation 19 of the SEBI Listing Regulations and its terms of reference are as follows:

- (a) To be responsible for identifying and nominating, for the approval of the Board and ultimately the shareholders, candidates to fill Board vacancies as and when they arise as well as putting in place plans for succession, in particular with respect to the Chairman of the Board and the Chief Executive Officer;
- (b) Formulation of the criteria for determining qualifications, positive attributes and independence of a director and recommend to the Board a policy, relating to the remuneration of the directors, key managerial personnel and other employees;
- (c) The below is the term of reference of NRC:
  - i. the level and composition of remuneration be reasonable and sufficient to attract, retain and motivate directors of the quality required to run our Company successfully;
  - ii. relationship of remuneration to performance is clear and meets appropriate performance benchmarks; and
  - iii. remuneration to directors, key managerial personnel and senior management involves a balance between fixed and incentive pay reflecting short- and long-term performance objectives appropriate to the working of the Company and its goals.
- (d) Formulation of criteria for evaluation of performance of independent directors and the Board;
- (e) For every appointment of an independent director, evaluate the balance of skills, knowledge, and experience on the board and on the basis of such evaluation, prepare a description of the role and capabilities required of an independent director. The person recommended to the board for appointment as an independent director shall have the capabilities identified in such description. For the purpose of identifying suitable candidates, the committee may (a) use the services of an external agencies, if required; (b) consider candidates from a wide range of backgrounds, having due regard to diversity; and (c) consider the time commitments of the candidates;
- (f) Devising a policy on Board diversity;

- (g) Identifying persons who are qualified to become directors of the Company and who may be appointed in senior management in accordance with the criteria laid down and recommend to the Board their appointment and removal. The Company shall disclose the remuneration policy and the evaluation criteria in its annual report;
- (h) Analysing, monitoring, and reviewing various human resource and compensation matters;
- (i) Determining the Company's policy on specific remuneration packages for executive directors including pension rights and any compensation payment, and determining remuneration packages of such directors;
- (j) Recommending the remuneration, in whatever form, payable to the senior management personnel and other staff (as deemed necessary);
- (k) Reviewing and approving compensation strategy from time to time in the context of the then current Indian market in accordance with applicable laws;
- (l) Determining whether to extend or continue the term of appointment of the independent director, on the basis of the report of performance evaluation of independent directors;
- (m) Perform such functions as are required to be performed by the compensation committee under the Securities and Exchange Board of India (Share Based Employee Benefits and Sweat Equity) Regulations, 2021 as may be amended from time to time;
- (n) Construing and interpreting the ESOP Scheme and any agreements defining the rights and obligations of the Company and eligible employees under the ESOP Scheme, and prescribing, amending and/or rescinding rules and regulations relating to the administration of the ESOP Scheme;
- (o) Framing suitable policies, procedures, and systems to ensure that there is no violation of securities laws, as amended from time to time, including:
  - i. the Securities and Exchange Board of India (Prohibition of Insider Trading) Regulations, 2015, as amended; and
  - ii. the Securities and Exchange Board of India (Prohibition of Fraudulent and Unfair Trade Practices Relating to the Securities Market) Regulations, 2003, as amended;
 by the Company and its employees, as applicable;
- (p) To administer the employee stock option scheme/plan approved by the Board and shareholders of the Company in accordance with the terms of such scheme/plan ("**ESOP Scheme**") including the following:
  - i. Determining the eligibility of employees to participate under the ESOP Scheme;
  - ii. Determining the quantum of option to be granted under the ESOP Scheme per employee and in aggregate;
  - iii. Date of grant;
  - iv. Determining the exercise price of the option under the ESOP Scheme;
  - v. The conditions under which option may vest in employee and may lapse in case of termination of employment for misconduct;
  - vi. The exercise period within which the employee should exercise the option and that option would lapse on failure to exercise the option within the exercise period;
  - vii. The specified time period within which the employee shall exercise the vested option in the event of termination or resignation of an employee;
  - viii. The right of an employee to exercise all the options vested in him at one time or at various points of time within the exercise period;

- ix. Re-pricing of the options which are not exercised, whether or not they have been vested if stock option rendered unattractive due to fall in the market price of the equity shares;
- x. The grant, vest and exercise of option in case of employees who are on long leave;
- xi. Allow exercise of unvested options on such terms and conditions as it may deem fit;
- xii. The procedure for cashless exercise of options;
- xiii. formulate the procedure for funding the exercise of options;
- xiv. Forfeiture/ cancellation of options granted;
- xv. Formulate the procedure for buy-back of specified securities issued under the SBEB Regulations, if to be undertaken at any time by the Company, and the applicable terms and conditions, including:
  - permissible sources of financing for buy-back; and
  - any minimum financial thresholds to be maintained by the Company as per its last financial statements;
- xvi. Limits upon quantum of specified securities that the Company may buy-back in a financial year.
- xvii. Formulating and implementing the procedure for making a fair and reasonable adjustment to the number of options and to the exercise price in case of corporate actions such as rights issues, bonus issues, merger, sale of division and others. In this regard following shall be taken into consideration:
  - (a) The number and the price of stock option shall be adjusted in a manner such that total value of the option to the employee remains the same after the corporate action;
  - (b) For this purpose, follow global best practices in this area including the procedures followed by the derivative markets in India and abroad may be considered; and
  - (c) The vesting period and the life of the option shall be left unaltered as far as possible to protect the rights of the employee who is granted such option.
- (q) To construe and interpret the ESOP Scheme and any agreements defining the rights and obligations of the Company and eligible employees under the ESOP Scheme, and prescribing, amending and/or rescinding rules and regulations relating to the administration of the ESOP Scheme;
- (r) Performing such other activities as may be delegated by the Board and/or are statutorily prescribed by any law to be required to be attended by the Nomination and remuneration committee;
- (s) Such terms of reference as may be prescribed under the Companies Act and SEBI Listing Regulations; and
- (t) To make available its terms of reference and review annually those terms of reference and its own effectiveness and recommend any necessary changes to the Board.

### 3. **Corporate Social Responsibility Committee (“CSR Committee”)**

The CSR Committee was constituted by a resolution of our Board dated October 28, 2021. The current constitution of the CSR Committee is as follows:

<b>Name of Director</b>	<b>Position in the Committee</b>	<b>Designation</b>
Aryaman Sanjay Thakker	Chairman	Executive Director
Ramakant Sharma	Member	Independent Director
Paras Somani	Member	Executive Whole -Time Director

The terms of reference of the CSR Committee framed in accordance with Section 135 of the Companies Act, 2013,



shall be restated as under:

- (a) To formulate and recommend to the board, a corporate social responsibility policy which shall indicate the activities to be undertaken by the Company as specified in Schedule VII of the Companies Act and the rules made thereunder and make any revisions therein as and when decided by the Board;
- (b) To identify corporate social responsibility policy partners and corporate social responsibility policy programmes;
- (c) To recommend the amount of expenditure to be incurred for the corporate social responsibility activities and the distribution of the same to various corporate social responsibility programmes undertaken by the Company;
- (d) To delegate responsibilities to the corporate social responsibility team and supervise proper execution of all delegated responsibilities;
- (e) To review and monitor the implementation of corporate social responsibility programmes and issuing necessary directions as required for proper implementation and timely completion of corporate social responsibility programmes;
- (f) To perform such other duties and functions as the Board may require the corporate social responsibility committee to undertake to promote the corporate social responsibility activities of the Company and exercise such other powers as may be conferred upon the CSR Committee in terms of the provisions of Section 135 of the Companies Act; and
- (g) All such activities may be notified from time to time.”

#### 4. **Stakeholders Relationship Committee (“SRC”)**

The SRC was constituted by a resolution of our Board dated October 28, 2021. The current constitution of the SRC is as follows:

<b>Name of Director</b>	<b>Position in the Committee</b>	<b>Designation</b>
Gautam Yogendra Trivedi	Chairman	Independent Director
Ramakant Sharma	Member	Independent Director
Aryaman Sanjay Thakker	Member	Executive Director

The scope and function of the SRC is in accordance with Regulation 20 of the SEBI Listing Regulations and its terms of reference are as follows:

- (a) Redressal of the grievances of the security holders of the listed entity including complaints related to transfer/transmission of shares, non-receipt of annual report, non-receipt of declared dividends, issue of new/duplicate certificates, general meetings etc.;
- (b) Reviewing of measures taken for effective exercise of voting rights by shareholders;
- (c) Reviewing the measures and initiatives taken by the Company for reducing the quantum of unclaimed dividends and ensuring timely receipt of dividend warrants/annual reports/statutory notices by the shareholders of the Company;
- (d) Reviewing the adherence to the service standards by the Company with respect to various services rendered by the registrar and transfer agent of our Company and to recommend measures for overall improvement in the quality of investor services; and
- (e) Carrying out such other functions as may be specified by the Board from time to time or specified/provided under the Companies Act or SEBI Listing Regulations, or by any other regulatory authority.

#### 5. **Risk Management Committee (“RMC”)**

The RMC was constituted by a resolution of our Board dated October 28, 2021. The current constitution of the RMC is as follows:

Name of Director	Position in the Committee	Designation
Manish Balkishan Chokhani	Chairman	Independent Director
Akshay Tanna	Member	Nominee Director of TPG Growth
Surendra Kumar Agarwal	Member	Chief Financial Officer

The scope and function of the RMC is in accordance with Regulation 21 of the SEBI Listing Regulations and its terms of reference shall be as follows:

- (a) To formulate a detailed risk management policy which shall include:
  - i. framework for identification of internal and external risks specifically faced by the Company, in particular including financial, operational, sectoral, sustainability (particularly, Environmental, Social and Governance (ESG) related risks), information, cyber security risks or any other risk as may be determined by the Committee;
  - ii. measures for risk mitigation including systems and processes for internal control of identified risks; and
  - iii. business continuity plan.
- (b) To ensure that appropriate methodology, processes and systems are in place to monitor and evaluate risks associated with the business of the Company;
- (c) To monitor and oversee implementation of the risk management policy, including evaluating the adequacy of risk management systems;
- (d) To periodically review the risk management policy, at least once in two years, including by considering the changing industry dynamics and evolving complexity;
- (e) To keep the Board informed about the nature and content of its discussions, recommendations and actions to be taken;
- (f) To review the appointment, removal, and terms of remuneration of the Chief Risk Officer, if any;
- (g) To coordinate its activities with other committees, in instances where there is any overlap with activities of such committees, as per the framework laid down by the Board;
- (h) To monitor and review the risk management plan and perform such other functions including specifically cyber security, as may be delegated by the Board.

### Management organization chart

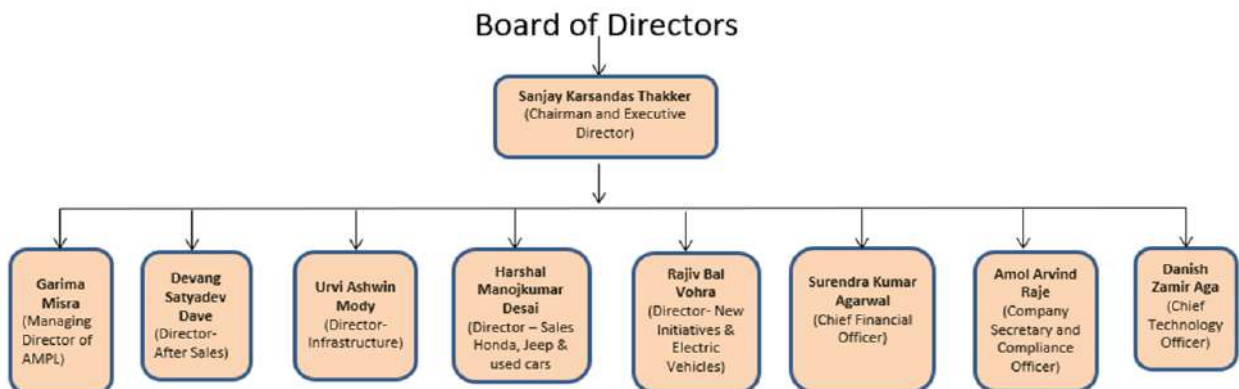

## Key Managerial Personnel

In addition to Sanjay Karsandas Thakker, our Chairman and Executive Director, Paras Somani, our Executive Whole-Time Director and Aryaman Sanjay Thakker, our Executive Director, whose details are provided in “*Our Management-Brief profiles of our Directors*” on page 182, the details of our other Key Managerial Personnel as on the date of this Draft Red Herring Prospectus are as set forth below:

**Garima Misra** is the managing director of AMPL (Volkswagen business), Jeep North and Group Marketing. She has been associated with Group Landmark since September 5, 1998. She holds a bachelors’ degree in commerce (honours) from the Delhi University and a master’s degree in business administration from Fore School of Management. She has 23 years of experience in automobile retail industry and was a part of the founding team at Group Landmark. Prior to joining Group Landmark, she was associated with Blue Skies Travels & Tours Private Limited. She has been appointed as the state chairperson of Delhi chapter of the Federation of Automobile Dealers Associations for the period 2020-2022. For Fiscal 2021, she received ₹8.23 million from our Company as remuneration.

**Urvi Ashwin Mody** is the Director -Infrastructure in Group Landmark. She holds a diploma in architecture from the Board of Technical Examinations, Maharashtra and a diploma in business management from S. P Mandali’s WE School, Prin. L.N. Welingkar Institute of Management Development & Research, Mumbai. She is also registered with the Council of Architecture. She has been with Group Landmark since October 1, 1999. She has 22 years of experience in setting up retail and factory infrastructure. For Fiscal 2021, she received ₹ 4.02 million from our Company as remuneration.

**Surendra Kumar Agarwal** is the Chief Financial Officer of our Company and has been associated with our Company since 2018. He holds a bachelors’ degree in commerce from Rajasthan University and is also an associate of the Institute of Chartered Accountants of India. He has over two decades of experience in finance and accounting roles. Prior to this, he was associated with Trent Hypermarket Private Limited Videocon Appliances Limited and Century Rayon. For Fiscal 2021, he received ₹ 5.78 million from our Company as remuneration.

**Devang Satyadev Dave** is the Director - After Sales with Group Landmark. He holds an advanced diploma in management from the ICFAI University, Dehradun. He has been with Group Landmark since February 15, 2002. He has 19 years of experience in the automobile industry. For Fiscal 2021, he received ₹ 7.44 million from our Company as remuneration.

**Harshal Manojkumar Desai** is the Director – Sales -Honda, Jeep (Mumbai) and used cars business in Group Landmark. He holds a bachelor’s degree in science from Maharaja Sayajirao University of Baroda. He has over 23 years of experience in the automobile industry. He oversees sales for Honda passenger vehicles in LAPL and holds directorship on the boards of LLCPL and WCPL. He is also in-charge the pre-owned car business for the Group Landmark. He has been associated with Group Landmark since 2007 when he was appointed as a General Manager- Sales in LAPL. Prior to joining our Company, he was associated with Kamdhenu Motors Private Limited for ten years. For Fiscal 2021, he received ₹ 4.88 million as remuneration from our Company.

**Rajiv Bal Vohra** is the Director - New Initiatives and Electric Vehicles in Group Landmark. He holds a bachelors’ degree in electrical engineering from the Bangalore University and a master’s degree in international business from the Indian Institute of Foreign Trade. He has been associated with our Company since December 1, 2016 and has over 23 years of experience in marketing. He has previously worked with Trading Enterprises, Al Futtaim Group, Dubai, H D Motor Company India Private Limited (Harley-Davidson, India) and Honda Siel Cars India Limited. For Fiscal 2021, he received ₹ 7.90 million from our Company as remuneration.

**Amol Arvind Raje** is the Company Secretary and Compliance Officer of our Company. He holds a bachelor’s degree in commerce and bachelor’s degree in law from the University of Mumbai and is also an associate member of the Institute of Company Secretaries of India. He has been associated with our Company since 2021. He has 16 years of experience and has been previously associated with Bombay Dyeing & Manufacturing Company Limited, And Designs India Limited, and Tara Jewels Limited. For Fiscal 2021, he received ₹ 0.60 million from our Company as remuneration.

**Danish Zamir Aga** is the Chief Technology Officer-Business Intelligence Cell of our Company. He holds a bachelor’s degree in electronics and telecommunication engineering from University of Mumbai and has been with our Company since 2021. He has over 15 years of global experience in managing strategic, and legacy technology transformation projects, primarily in, financial services, foreign exchange, and telecom domains. He has previously worked with i2i Enterprise Limited and has been a part of technology leadership team for organizations like Bank of America Merrill Lynch and J. P. Morgan Services India Private Limited. For Fiscal 2021, he received ₹ 0.64 million from our Company as remuneration.

### **Status of the Key Managerial Personnel**

All our Key Managerial Personnel are permanent employees of our Company. Pursuant to conversion of our Company from private to public, our Company passed a resolution dated October 28, 2021, under Section 203 of the Act appointing Surendra Kumar Agarwal as the KMP i.e. CFO of the Company.

### **Retirement and termination benefits**

Except applicable statutory and contractual (if any) benefits, none of our Key Managerial Personnel would receive any benefits on their retirement or on termination of their employment with our Company.

### **Family relationships of Directors with Key Managerial Personnel**

Except as stated below, none of our Key Managerial Personnel are related to any of our Directors, or other Key Managerial Personnel.

- Urvi Ashwin Mody is the sister of the spouse of Sanjay Karsandas Thakker and aunt of Aryaman Sanjay Thakker.

### **Arrangements and Understanding with Major Shareholders**

None of our Key Managerial Personnel have been selected pursuant to any arrangement or understanding with any major Shareholders, customers or suppliers of our Company, or others.

### **Shareholding of the Key Managerial Personnel**

Except as stated below, none of our Key Managerial Personnel (other than Executive Directors) hold any Equity Shares as on date of this Draft Red Herring Prospectus.

<b>S. No.</b>	<b>Name</b>	<b>No. of Equity Shares</b>	<b>Percentage of the pre-Offer Equity Share capital (%)</b>
1.	Garima Misra	1,012,012	2.76%

### **Service Contracts with Key Managerial Personnel**

Our Directors and Key Managerial Personnel have not entered into any service contracts with our Company.

### **Contingent and deferred compensation payable to Key Managerial Personnel**

There is no contingent or deferred compensation payable to Key Managerial Personnel, which does not form part of their remuneration.

### **Bonus or profit-sharing plan of the Key Managerial Personnel**

Except for the performance linked bonus payable to certain of our Key Managerial Personnel namely Paras Somani, Urvi Ashwin Mody, Devang Satyadev Dave, Harshal Manojkumar Desai, Rajiv Bal Vohra and Garima Misra, for the Financial Year 2021-22, none of our Key Managerial Personnel are a party to any bonus or profit-sharing plan of our Company.

### **Interest of Key Managerial Personnel**

For details of the interest of our Executive Directors in our Company, see “*Our Management - Interest of Directors*” on page 185.

Our Key Managerial Personnel (other than our Directors and Promoter) are interested in our Company only to the extent of (i) the remuneration or benefits to which they are entitled in accordance with the terms of their appointment or reimbursement of expenses incurred by them during the ordinary course of their business by our Company; and (ii) the Equity Shares and employee stock options held by them, if any, and any dividend payable to them and other benefits arising out of such shareholding.

### **Changes in the Key Managerial Personnel in last three years:**

For details of the changes in our Executive Directors, see “*Our Management - Changes to our Board in the last three years*” on page 185. The changes in our Key Managerial Personnel (other than our Directors) in the three years preceding the date of this Draft Red Herring Prospectus is as mentioned below:

<b>Name</b>	<b>Designation</b>	<b>Date of Change</b>	<b>Reason</b>
Shrikant Rashmikant Khatri	Company secretary	March 29, 2021	Resignation and further appointment as company secretary of LLCPL.
Amol Arvind Raje*	Company Secretary	March 29, 2021	Appointment
Danish Zamir Aga	Chief Technology Officer- Business Intelligence Cell	February 15, 2021	Appointment

\* *Amol Arvind Raje has been appointed as the Compliance Officer to the Offer by the IPO Committee at their meeting held on January 11, 2022.*

The attrition of the Key Managerial Personnel of our Company is not high compared to the industry.

#### **Payment or Benefit to officers of our Company (non-salary related)**

Except as disclosed under “*Our Management - Payment of benefits to Directors*” on page 184, no amount or benefit has been paid or given since incorporation or intended to be paid or given to any officer of the Company, including our directors and Key Managerial Personnel.

#### **Employee stock options**

For details of our Company’s employee stock option plan, see “*Capital Structure – Employee Stock Option Scheme*” on page 81.

## OUR PROMOTER AND PROMOTER GROUP

### Promoter

The Promoter of our Company is Sanjay Karsandas Thakker.

As on the date of this Draft Red Herring Prospectus, our Promoter holds 15,154,768 Equity Shares, representing 41.38% of the issued, subscribed and paid-up Equity Share capital of our Company. For details, please see the section titled “*Capital Structure – Notes to Capital Structure - Details of shareholding of our Promoter and members of the Promoter Group in our Company*” beginning on page 84.

Details of our Promoter are as follows:



*Sanjay Karsandas Thakker*, aged 56 years, is the Promoter and is also the Chairman and Executive Director of our Company.

PAN: AACPT2376C

For the complete profile of Sanjay Karsandas Thakker, along with details of his date of birth, personal address, educational qualifications, professional experience, position/posts held in the past, directorships held, special achievements and business and financial activities, see “*Our Management – Board of Directors*” on page 178 and “*Our Management – Brief profiles of Directors*” on page 181.

Our Company confirms that the PAN, bank account number, Aadhar card number, driving licence number and passport number of Sanjay Karsandas Thakker shall be submitted to the Stock Exchanges at the time of filing this Draft Red Herring Prospectus.

### Other ventures of our Promoter

Other than as disclosed below and in the section “*Our Management – Board of Directors*” on page 178, our Promoter is not involved in any other ventures.

Name of venture	Nature of interest of Promoter
Ankan Printers LLP	Partner
Ranchhoddas Jethabhai and Co	Partner

### Change in control of our Company

There has been no change in control of our Company in the five years immediately preceding the date of this Draft Red Herring Prospectus.

### Interests of the Promoter

Our Promoter is interested in our Company to the extent he is the Promoter of our Company and to the extent of his respective shareholding in our Company (directly or indirectly, as the case may be), the dividend payable, interest payable on the loans provided to the Company, any other distributions in respect of his respective shareholding in our Company and the rights afforded to him in terms of the Shareholders Agreement. Further, our Promoter is also interested in our Company to the extent of remuneration payable to him in his capacity as the Chairman and Executive Director of our Company. He has also received benefits *inter alia*, a vehicle for official use, being the Chairman and Executive Director. For further details, see “*Capital Structure - Notes to Capital Structure – Details of shareholding of our Promoter and members of the Promoter Group in our Company*” beginning on page 84. Additionally, our Promoter may be interested in transactions entered into by our Company with other entities (i) in which our Promoter holds shares, or (ii) controlled by our Promoter.

No sum has been paid or agreed to be paid to our Promoter or to any firm or company in which our Promoter is interested, in cash or shares or otherwise by any person, either to induce him to become or to qualify him, as a director or promoter or otherwise for services rendered by him or by such firm or company, in connection with the promotion or formation of our Company.

Our Promoter has no interest in any property acquired by our Company in the preceding three years from the date of this Draft Red Herring Prospectus or proposed to be acquired by our Company or in any transaction with respect to the acquisition of land, construction of building or supply of machinery.

Our Promoter has no interest in any venture that is involved in the same line of business or activity to those conducted by our Company and its Subsidiaries.

As on the date of this September 30, 2021, our Promoter has extended a loan of ₹ 79.50 million (excluding interest) to our Company and its Subsidiaries.

#### **Payment or Benefits to Promoter or Promoter Group**

Except as disclosed herein and as stated in “*Restated Consolidated Financial Information - Related Party Transactions*” on page 251, the remuneration paid to the Promoter in his capacity as a director as stated in “*Our Management – Payment of benefits to directors – Executive Directors*” on page 183, and dividend payable, there has been no amount paid or benefits given by our Company to our Promoter or any of the members of the Promoter Group during the two years preceding the date of this Draft Red Herring Prospectus nor is there any intention to pay any amount or give any benefit to our Promoter or Promoter Group as on the date of this Draft Red Herring Prospectus.

#### **Companies or firms with which our Promoter have disassociated in the last three years**

Our Promoter has not disassociated himself from any other company or firm in the three years preceding the date of this Draft Red Herring Prospectus.

#### **Material Guarantees**

As on the date of this Draft Red Herring Prospectus, our Promoter has not given any material guarantee to any third party with respect to the Equity Shares.

#### **Promoter Group**

In addition to our Promoter, the individuals and entities that form a part of the Promoter Group of our Company in terms of Regulation 2(1)(pp) of the SEBI ICDR Regulations are set out below:

#### **Natural persons who are part of the Promoter Group**

The natural persons who are part of the Promoter Group, are as follows:

<b>Sr. No.</b>	<b>Name of member of our Promoter Group</b>	<b>Relationship with our Promoter</b>
1.	Ami Sanjay Thakker	Spouse
2.	Udayan Karsandas Thakker	Brother
3.	Aryaman Sanjay Thakker	Son
4.	Aparajita Sanjay Thakker	Daughter
5.	Smita Ashwin Mody	Mother of spouse
6.	Urvi Ashwin Mody	Sister of spouse

#### **Entities forming part of the Promoter Group**

The entities, partnerships and proprietorships forming part of our Promoter Group by virtue of such entities being controlled by our Promoter or persons related to our Promoter, are as follows:

1. Ekta Housemakers Private Limited;
2. Landmark Pre-Owned Cars Private Limited;
3. Wild Dreams Trading Company Private Limited;
4. Kamlesh Real Estates Private Limited;
5. Sewri Land Company Private Limited;

6. Wild Dreams Media and Communications Private Limited;
7. Landmark Insurance Brokers Private Limited;
8. Interstellar Services Private Limited;
9. Express BPO Services Private Limited;
10. Ankan Printers LLP;
11. Adorn Studio LLP;
12. Acadia Marketing LLP;
13. Curated Journeys2xplor LLP;
14. Ranchhoddas Jethabhai and Co.;
15. Sanjay Karsandas Thakker HUF;
16. Karsandas Ranchhoddas Thakker HUF; and
17. Udayan Karsandas Thakker (HUF).



## GROUP COMPANIES

In terms of the SEBI ICDR Regulations, the term “group companies”, includes (i) such companies (other than the Promoter and the Subsidiaries) with which there were related party transactions during the period for which financial information is disclosed, as covered under applicable accounting standards, and (ii) any other companies considered material by the Board.

Accordingly, all such companies with which our Company had related party transactions as covered under the relevant accounting standard (i.e., Ind AS 24), as per the Restated Consolidated Financial Information, have been considered as Group Companies in terms of the SEBI ICDR Regulations.

In addition to the above, pursuant to the Materiality Policy, a company shall be considered material and shall be disclosed as a Group Company in this Draft Red Herring Prospectus if such company is a member of the Promoter Group with which there were one or more transactions during the most recently completed fiscal year or the most recent period disclosed in the Restated Consolidated Financial Information, which individually or cumulatively in value exceeds 10% of the total consolidated income of our Company for the latest fiscal year as per the Restated Consolidated Financial Information.

Based on the above, our Group Companies are set forth below:

1. Wild Dreams Media and Communications Private Limited;
2. Landmark Insurance Brokers Private Limited; and
3. Landmark Pre-Owned Cars Private Limited.

### *Details of our Group Companies*

The details of our Group Companies are provided below:

#### **1. Wild Dreams Media and Communications Private Limited (“WDMCPL”)**

##### *Registered office*

The registered office of WDMCPL is situated at 3<sup>rd</sup> Floor, Landmark House, Near Gurudwara, Thaltej, S. G. Highway, Ahmedabad – 380 059, Gujarat, India.

##### *Financial information*

Certain financial information derived from the audited financial statements of WDMCPL for the last three financial years, as required by the SEBI ICDR Regulations, are available on the website of our Company at <https://www.grouplandmark.in/corporate-document/>.

#### **2. Landmark Insurance Brokers Private Limited (“LIBPL”)**

##### *Registered office*

The registered office of LIBPL is situated at 1187/22, 4<sup>th</sup> Floor, Venkatesh Meher, Ghole Road Shivaji Nagar, Pune 411 005, Maharashtra, India.

##### *Financial information*

Certain financial information derived from the audited financial statements of LIBPL for the last three financial years, as required by the SEBI ICDR Regulations, are available on the website of our Company at <https://www.grouplandmark.in/corporate-document/>.

#### **3. Landmark Pre-Owned Cars Private Limited (“LPOCPL”)**

##### *Registered office*

The registered office of LPOCPL is situated at 3<sup>rd</sup> Floor, Landmark House, Opposite AEC, Near Gurudwara, Thaltej, S.G. Highway, Ahmedabad 380 059, Gujarat, India.

#### *Financial information*

Certain financial information derived from the audited financial statements of LPOCPL for the last three financial years, as required by the SEBI ICDR Regulations, are available on the website of our Company at <https://www.grouplandmark.in/corporate-document/>.

#### **Nature and extent of interest of Group Companies**

##### *In the promotion of our Company*

None of our Group Companies have any interest in the promotion of our Company.

##### *In the properties acquired by our Company in the past three years before filing this Draft Red Herring Prospectus or proposed to be acquired by our Company*

None of our Group Companies are interested in the properties acquired by our Company in the three years preceding the filing of this Draft Red Herring Prospectus or proposed to be acquired by our Company.

##### *In transactions for acquisition of land, construction of building and supply of machinery, etc.*

None of our Group Companies are interested in any transactions for acquisition of land, construction of building or supply of machinery, etc. entered into by our Company.

#### **Common pursuits**

As on the date of this Draft Red Herring Prospectus, there are no common pursuits between our Group Companies and our Company.

#### **Related business transactions within our Group Companies and significance on the financial performance of our Company**

Except the transactions disclosed in “*Related Party Transactions*” and “*Restated Consolidated Financial Information – Related Party Transactions*” on pages 271 and 251, there are no other related business transactions with the Group Companies.

#### **Litigation**

There are no litigation proceedings involving our Group Companies which may have a material impact on our Company.

#### **Business interest of Group Companies**

Except in the ordinary course of business and as stated in “*Related Party Transactions*” on page 271, none of our Group Companies have any business interest in our Company.

#### **Confirmations**

None of our Group Companies have any securities listed on a stock exchange. Further, none of our Group Companies has made any public or rights issue (as defined under the SEBI ICDR Regulations) of securities in the three years preceding the date of this Draft Red Herring Prospectus.

*It is clarified that details available on the websites of our Group Companies and our Company do not form part of this Draft Red Herring Prospectus. Anyone placing reliance on any other source of information, including the websites of Company or our Group Companies mentioned above, would be doing so at their own risk.*

## DIVIDEND POLICY

The declaration and payment of dividends will be recommended by our Board and approved by our Shareholders, at their discretion and subject to the provisions of the Articles of Association and applicable law, including the Companies Act. The dividend policy of our Company was approved and adopted by way of a resolution dated January 11, 2022, passed by our Board of Directors.

The Board shall, *inter alia*, consider certain financial, internal and external parameters before declaring dividend including level of debt, capital expenditure requirement, working capital requirement and profit earned during the year. Our Company may also, from time to time, pay interim dividends. The objective of the dividend policy is rewarding its Shareholders and retaining capital for growth and ensuring fairness, sustainability, and consistency in distributing profits to Shareholders.

The details of the dividend paid by our Company on the Equity Shares during the last three Fiscals and the six months period ended September 30, 2021, are given below:

Particulars	Six months ended September 30, 2021	Fiscal 2021	Fiscal 2020	Fiscal 2019
Number of equity shares at year/period ended	18,312,810	18,312,810	18,312,810	79,12,590
Face value per equity share (in ₹)	10	10	10	10
Dividend paid (in ₹ million)	13.74	Nil	Nil	13.37
Dividend per Equity Share (in ₹)	0.75	Nil	Nil	1.69
Rate of dividend (%)	7.50	Nil	Nil	16.90
Dividend distribution tax (in ₹ million)	Not applicable	Nil	Nil	2.72
Dividend distribution tax (%)	Not applicable	Not applicable	Not applicable	20.36
Mode of payment of dividend	Bank transfer	Nil	Nil	Bank transfer

*Note: The dividend for Fiscal Year 2017-2018 was paid in Fiscal Year 2018-2019 and Fiscal Year 2020-2021 was paid in Fiscal Year 2021-2022*

Our Company has not declared or paid any dividend from October 1, 2021 until the date of this Draft Red Herring Prospectus.

In addition, our ability to pay dividends may be impacted by a number of factors, including restrictive covenants under the loan or financing arrangements our Company is currently availing of or may enter into to finance our fund requirements for our business activities. For further details, please see the section entitled “*Financial Indebtedness*” on page 311.

The amount of dividend paid in the past is not necessarily indicative of the dividend policy of our Company or dividend amounts, if any, in the future. There is no guarantee that any dividends will be declared or paid or the amount thereof will be decreased in the future. For details, see “*Risk Factors – We cannot assure payment of dividends on the Equity Shares in the future.*” on page 55.

**SECTION VI – FINANCIAL INFORMATION**  
**RESTATED CONSOLIDATED FINANCIAL INFORMATION**

*[The remainder of this page has intentionally been left blank]*

## **INDEPENDENT AUDITOR’S EXAMINATION REPORT ON RESTATED CONSOLIDATED FINANCIAL INFORMATION**

The Board of Directors

Landmark Cars Limited (Formerly known as “Landmark Cars Private Limited”)

Dear Sirs,

1. We have examined the attached Restated Consolidated Financial Information of Landmark Cars Limited (Formerly known as “Landmark Cars Private Limited”) (the “Company”), and its subsidiaries (the Company and its subsidiaries are collectively referred to as the “Group”) which comprises of the Restated Consolidated Statement of Assets and Liabilities as at September 30, 2021, March 31 2021, 2020 and 2019, the Restated Consolidated Statements of Profit and Loss (including other comprehensive income), Restated Consolidated Statement of changes in equity and the Restated Consolidated Statement of Cash Flows for the period of six months ended September 30, 2021 and for the years ended March 31 2021, 2020 and 2019, and a summary of Significant Accounting Policies, and other explanatory information (collectively, the “Restated Consolidated Financial Information”), as approved by the Board of Directors of the Company (“the Board”) at their meeting held on January 17, 2022 for the purpose of inclusion in the Draft Red Herring Prospectus (“DRHP”) prepared by the Company in connection with its proposed initial public offer of equity shares (“IPO”) prepared in terms of the requirements of:
  - a) Section 26 of Part I of Chapter III of the Companies Act, 2013, as amended (“the Act”);
  - b) the Securities and Exchange Board of India (Issue of Capital and Disclosure Requirements) Regulations, 2018, as amended (the “ICDR Regulations”); and
  - c) the Guidance Note on Reports in Company Prospectuses (Revised 2019) issued by the Institute of Chartered Accountants of India (“ICAI”), as amended from time to time (the “Guidance Note”) read with SEBI Communication as mentioned in Note 2.1 to the Restated Consolidated Financial Information, as applicable.
2. The Company’s Board of Directors is responsible for the preparation of the Restated Consolidated Financial Information for the purpose of inclusion in the DRHP to be filed with Securities and Exchange Board of India (the “SEBI”), BSE Limited and National Stock Exchange of India Limited (collectively, with BSE Limited, the “Stock Exchanges”) in connection with the IPO. The Restated Consolidated Financial Information have been prepared by the management of the Company on the basis of preparation stated in Note 2.1 to the Restated Consolidated Financial Information. The responsibility of the respective board of directors of the companies included in the Group includes designing, implementing and maintaining adequate internal control relevant to the preparation and presentation of the Restated Consolidated Financial Information. The respective board of directors are also responsible for identifying and ensuring that the Group complies with the Act, ICDR Regulations and the Guidance Note read with SEBI Communication, as applicable.
3. We have examined these Restated Consolidated Financial Information taking into consideration:
  - a) The terms of reference and terms of our engagement agreed upon with you in accordance with our engagement letter dated January 17, 2022 in connection with the IPO;
  - b) The Guidance Note read with SEBI Communication, as applicable. The Guidance Note also requires that we comply with the ethical requirements of the Code of Ethics issued by the ICAI;
  - c) Concepts of test checks and materiality to obtain reasonable assurance based on verification of evidence supporting the Restated Consolidated Financial Information; and
  - d) The requirements of Section 26 of the Act and the ICDR Regulations. Our work was performed solely to assist you in meeting your responsibilities in relation to your compliance with the Act, the ICDR Regulations and the Guidance Note read with SEBI Communication, as applicable in connection with the IPO.

4. These Restated Consolidated Financial Information have been compiled by the management from:
- i. the audited Special Purpose Consolidated Interim Ind AS Financial Statements of the Group as at and for six month period ended September 30, 2021 prepared in accordance with the recognition and measurement principles of Indian Accounting Standard (Ind AS) 34 "Interim Financial Reporting", as prescribed under section 133 of the Act read with Companies (Indian Accounting Standards) Rules 2015, as amended and other accounting principles generally accepted in India (the "Special Purpose Consolidated Interim Ind AS Financial Statements") which have been approved by the Board of Directors at their meeting held on January 17, 2022.
  - ii. the audited Consolidated Ind AS Financial Statements of the Group as at and for the year ended March 31, 2021 along with comparative audited consolidated Ind AS financial statements for the year ended March 31, 2020 (the "Consolidated Ind AS Financial Statements") which have been approved by the Board of Directors at their meeting held on July 23, 2021. The comparative information as at and for the year ended March 31, 2020 included in such Consolidated Ind AS Financial Statements have been prepared by making Ind AS adjustments to the audited consolidated Indian GAAP financial statements of the Group as at and for the year ended March 31, 2020, prepared in accordance with the accounting standards notified under the Section 133 of the Act ("Indian GAAP") which was approved by the Board of directors at their meeting held on December 31, 2020.
  - iii. the audited special purpose consolidated Ind AS financial statements as at and for the year ended March 31, 2019 prepared on the basis as described in Note 2(1) to the Restated Consolidated Financial Information, which have been approved by the Board of Directors at their meeting held on January 17, 2022.
5. For the purpose of our examination, we have relied on reports issued by us dated January 17, 2022, July 23, 2021 and January 17, 2022 in relation to the Special Purpose Consolidated Interim Ind AS Financial Statements of the Group as at and for the six month period ended September 30, 2021, Consolidated Ind AS Financial Statements of the Group as at and for the year ended March 31, 2021 and Special Purpose Consolidated Ind AS financial statements of the Group as at and for the year ended March 31, 2019 respectively as referred in Paragraph 4 above which includes the following explanatory paragraphs (also refer Note 2.1 of the Restated Consolidated Financial Information)

#### **Basis of Accounting and Restriction on Distribution and Use**

We draw attention to Note 2.1 to the Special Purpose Consolidated Ind AS Financial Statements, which describes the purpose and basis of preparation. The Special Purpose Consolidated Ind AS Financial Statements have been prepared by the Company solely for the purpose of preparation of the restated consolidated financial information as required under the Securities and Exchange Board of India (Issue of Capital and Disclosure Requirements) Regulations, 2018 as amended from time to time (the "ICDR Regulations") in relation to the proposed initial public offering of the Company and to comply with the SEBI Communication. As a result, the Special Purpose Consolidated Ind AS Financial Statements may not be suitable for any another purpose and are not financial statements prepared pursuant to any requirements under section 129 of the Companies Act, 2013. The Special Purpose Consolidated Ind AS Financial Statements cannot be referred to or distributed or included in any offering document or used for any other purpose except with our prior consent in writing. Our report is intended solely for the purpose of preparation of the restated consolidated financial information and to comply with SEBI Communication and is not to be used, referred to or distributed for any other purpose without our prior written consent.

Our opinion is not modified in respect of this matter.

6. Based on our examination and according to the information and explanations given to us, we report that the Restated Consolidated Financial Information:
- a) have been prepared after incorporating adjustments for the changes in accounting policies, material errors and regrouping / reclassifications retrospectively in the financial years ended March 31, 2021, 2020 and 2019 to reflect the same accounting treatment as per the accounting policies and grouping / classifications followed as at and for the six months period ended September 30, 2021;
  - b) do not require any adjustment for modification as there is no modification in the underlying audit reports. There is an item relating to emphasis of matter (refer paragraph 5 above), which do not require any adjustment to the Restated Consolidated Financial Information; and

- c) have been prepared in accordance with the Act, ICDR Regulations and the Guidance Note read with SEBI Communication, as applicable
7. We have complied with the relevant applicable requirements of the Standard on Quality Control (SQC) 1, Quality Control for Firms that Perform Audits and Reviews of Historical Financial Information, and Other Assurance and Related Services Engagements.
  8. The Restated Consolidated Financial Information do not reflect the effects of events that occurred subsequent to the respective dates of the reports on the audited Special Purpose Interim Consolidated Ind AS financial statements/ audited Consolidated Ind AS Financial Statements / audited Consolidated Indian GAAP Financial Statements mentioned in paragraph 4 above.
  9. This report should not in any way be construed as a reissuance or re-dating of any of the previous audit reports issued by us, nor should this report be construed as a new opinion on any of the financial statements referred to herein.
  10. We have no responsibility to update our report for events and circumstances occurring after the date of the report.
  11. Our report is intended solely for use of the Board of Directors for the purpose for inclusion in the DRHP to be filed with SEBI and Stock Exchanges in connection with the IPO. Our report should not be used, referred to, or distributed for any other purpose except with our prior consent in writing. Accordingly, we do not accept or assume any liability or any duty of care for any other purpose or to any other person to whom this report is shown or into whose hands it may come without our prior consent in writing.

For **DELOITTE HASKINS & SELLS**  
Chartered Accountants  
(Firm's Registration No: 117365W)

**Kartikeya Raval**  
Partner  
(Membership Number: 106189)  
UDIN: 22106189AAAABC8923

Place: Ahmedabad  
Date: January 17, 2022

Landmark Cars Limited (formerly known as Landmark Cars Private Limited)  
CIN: U50100GJ2006PLC058553  
Restated Consolidated Statement of Assets and Liabilities  
(All amount in INR Millions unless otherwise stated)

Particulars	Notes	As at			
		September 30, 2021	March 31, 2021	March 31, 2020	March 31, 2019
<b>ASSETS</b>					
<b>Non-current assets</b>					
Property, plant and equipment	5	1,969.52	1,901.03	2,114.45	2,270.75
Right-of-use assets	6	1,058.04	1,095.51	1,310.99	1,452.62
Capital Work-in-Progress	5	24.36	6.76	0.33	-
Goodwill	7	234.01	231.67	231.67	134.74
Other intangible assets	8	40.03	31.74	44.60	56.99
Intangible assets under development	8	9.07	8.96	6.41	4.38
Financial assets					
Investments	9	157.50	129.67	79.99	-
Loans	10	-	-	308.50	15.29
Other financial assets	11	166.66	125.52	148.03	168.45
Current tax assets	33	12.29	27.38	55.60	48.87
Deferred tax assets	33	117.21	56.73	49.03	88.65
Other non-current assets	12	21.63	21.31	6.41	4.63
<b>Total non-current assets</b>		<b>3,810.32</b>	<b>3,636.28</b>	<b>4,356.01</b>	<b>4,245.37</b>
<b>Current assets</b>					
Inventories	13	3,442.89	2,888.22	2,257.63	3,397.96
Financial assets					
Investments	9	-	-	22.50	-
Trade receivables	14	701.91	557.84	236.45	783.47
Cash and cash equivalents	15	586.95	150.34	277.01	322.44
Other balances with banks	16	119.25	76.86	56.26	43.24
Loans	10	396.38	563.41	148.61	64.87
Other financial assets	11	238.64	276.02	289.08	433.25
Current tax assets (net)	33	46.42	14.22	31.15	11.95
Other current assets	12	644.11	715.76	642.97	777.78
<b>Total current assets</b>		<b>6,176.55</b>	<b>5,242.67</b>	<b>3,961.66</b>	<b>5,834.96</b>
<b>Total assets</b>		<b>9,986.87</b>	<b>8,878.95</b>	<b>8,317.67</b>	<b>10,080.33</b>
<b>EQUITY AND LIABILITIES</b>					
<b>EQUITY</b>					
Equity share capital	17	183.13	183.13	183.13	183.13
Other equity	18	1,902.36	1,634.62	1,508.12	1,696.51
<b>Total equity attributable to equity holders of the parent</b>		<b>2,085.49</b>	<b>1,817.75</b>	<b>1,691.25</b>	<b>1,879.64</b>
Non-controlling interests		7.68	6.01	7.84	9.92
<b>Total equity</b>		<b>2,093.17</b>	<b>1,823.76</b>	<b>1,699.09</b>	<b>1,889.56</b>
<b>LIABILITIES</b>					
<b>Non-current liabilities</b>					
Financial liabilities					
Borrowings	19	466.88	487.65	525.68	456.21
Lease liabilities	42	950.25	1,028.35	1,233.23	1,284.47
Deferred tax liabilities	33	12.12	8.65	13.99	23.28
Other non-current liabilities	20	66.07	72.43	46.30	46.69
<b>Total non-current liabilities</b>		<b>1,495.32</b>	<b>1,597.08</b>	<b>1,819.20</b>	<b>1,810.65</b>
<b>Current liabilities</b>					
Financial liabilities					
Borrowings	19	2,369.29	1,603.26	1,274.49	2,051.58
Vehicle floor plan payable	21	1,252.26	1,183.50	1,778.91	2,279.97
Lease liabilities	42	343.53	331.34	238.28	301.58
Trade payables	22				
(i) total outstanding dues of micro enterprises and small enterprises		19.41	15.08	14.20	9.91
(ii) total outstanding dues of creditors other than micro enterprises and small enterprises		1,038.37	987.31	542.53	692.69
Other financial liabilities	23	57.25	49.76	70.18	104.12
Other current liabilities	20	1,309.80	1,225.17	873.44	939.73
Current tax liabilities (net)	33	8.47	62.69	7.35	0.54
<b>Total current liabilities</b>		<b>6,398.38</b>	<b>5,458.11</b>	<b>4,799.38</b>	<b>6,380.12</b>
<b>Total liabilities</b>		<b>7,893.70</b>	<b>7,055.19</b>	<b>6,618.58</b>	<b>8,190.77</b>
<b>Total equity and liabilities</b>		<b>9,986.87</b>	<b>8,878.95</b>	<b>8,317.67</b>	<b>10,080.33</b>

The accompanying notes 1 to 53 are an integral part of the Restated Consolidated Financial Information

In terms of our report attached

For Deloitte Haskins & Sells  
Chartered Accountants  
Firm's Registration Number: 117365W

For and on behalf of the Board of Directors

Kartikeya Raval  
Partner

Place: Ahmedabad  
Date: January 17, 2022

Sanjay Thakker  
Director  
DIN No. 00156093  
Place: Mumbai  
Date: January 17, 2022

Paras Somani  
Director  
DIN No. 02742256  
Place: Ahmedabad  
Date: January 17, 2022

Surendra Agarwal  
Chief Financial Officer  
Place: Mumbai  
Date: January 17, 2022

Amol Raje  
Company Secretary  
Membership No: A19459  
Place: Mumbai  
Date: January 17, 2022



Particulars	Notes	For the six months	For the year ended		
		period ended	March 31, 2021	March 31, 2020	March 31, 2019
		September 30, 2021			
<b>Income</b>					
Revenue from operations	24	14,128.42	19,561.04	22,186.14	28,265.18
Other income	25	69.51	102.39	103.19	80.98
<b>Total Income</b>		<b>14,197.93</b>	<b>19,663.43</b>	<b>22,289.33</b>	<b>28,346.16</b>
<b>Expenses</b>					
Purchase of cars, spares and others	26	12,768.26	17,104.29	17,808.48	24,776.35
Changes in inventories of stock-in-trade	27	(554.67)	(630.59)	1,140.33	(151.01)
Employee benefits expense	28	674.60	1,076.66	1,367.39	1,522.63
Finance costs	29	182.21	378.05	448.85	527.63
Depreciation and amortisation expense	30	310.98	624.77	629.52	534.16
Other expenses	31	533.22	912.44	1,141.18	1,311.92
<b>Total expenses</b>		<b>13,914.60</b>	<b>19,465.62</b>	<b>22,535.75</b>	<b>28,521.68</b>
<b>Restated Profit/(Loss) before tax</b>		<b>283.33</b>	<b>197.81</b>	<b>(246.42)</b>	<b>(175.52)</b>
<b>Tax expense</b>	33				
Current tax		61.45	103.08	12.81	55.73
Deferred tax		(57.59)	(16.75)	30.16	13.03
<b>Total tax expense</b>		<b>3.86</b>	<b>86.33</b>	<b>42.97</b>	<b>68.76</b>
<b>Restated Profit/(Loss) for the period / year</b>		<b>279.47</b>	<b>111.48</b>	<b>(289.39)</b>	<b>(244.28)</b>
<b>Other comprehensive income</b>					
<b>Items that will not be subsequently reclassified to profit and loss</b>					
Change in fair value of investment carried at fair value through other comprehensive income		2.53	16.89	-	-
Remeasurement gain/(loss) of defined benefit plans		1.63	-	-	-
Less: Income tax impact on above		0.99	3.71	-	-
<b>Restated Other comprehensive income for the period/year</b>		<b>3.17</b>	<b>13.18</b>	<b>-</b>	<b>-</b>
<b>Restated Total Comprehensive Income / (loss) for the period / year</b>		<b>282.64</b>	<b>124.66</b>	<b>(289.39)</b>	<b>(244.28)</b>
<b>Restated Profit/(Loss) for the period / year attributable to:</b>					
Owners of the Company		277.80	113.31	(287.31)	(252.55)
Non-controlling interests		1.67	(1.83)	(2.08)	8.27
		<b>279.47</b>	<b>111.48</b>	<b>(289.39)</b>	<b>(244.28)</b>
<b>Restated Other Comprehensive income for the period / year attributable to:</b>					
Owners of the company		3.17	13.18	-	-
Non-controlling interests		-	-	-	-
		<b>3.17</b>	<b>13.18</b>	<b>-</b>	<b>-</b>
<b>Restated Total Comprehensive income / (loss) for the period / year attributable to:</b>					
Owners of the company		280.97	126.49	(287.31)	(252.55)
Non-controlling interests		1.67	(1.83)	(2.08)	8.27
		<b>282.64</b>	<b>124.66</b>	<b>(289.39)</b>	<b>(244.28)</b>
<b>Restated Earnings/(loss) per Equity Share (Face value of Rs. 5/- each)</b>	32				
Basic (In Rs.)		7.58	3.09	(7.84)	(7.01)
Diluted (In Rs.)		7.40	3.05	(7.84)	(7.00)

The accompanying notes 1 to 53 are an integral part of the Restated Consolidated Financial Information

In terms of our report attached

For Deloitte Haskins & Sells  
Chartered Accountants  
Firm's Registration Number: 117365W

For and on behalf of the Board of Directors

Kartikeya Raval  
Partner

Place: Ahmedabad  
Date: January 17, 2022

Sanjay Thakker  
Director  
DIN No. 00156093  
Place: Mumbai  
Date: January 17, 2022

Paras Somani  
Director  
DIN No. 02742256  
Place: Ahmedabad  
Date: January 17, 2022

Surendra Agarwal  
Chief Financial Officer  
Place: Mumbai  
Date: January 17, 2022

Amol Raje  
Company Secretary  
Membership No: A19459  
Place: Mumbai  
Date: January 17, 2022

## A Equity Share Capital

Particulars	No. of shares	Amount
Balance as at April 1, 2018	79,12,590	79.13
Issued during the year (Refer Note 17.3)	1,04,00,220	104.00
<b>Balance as at March 31, 2019</b>	<b>1,83,12,810</b>	<b>183.13</b>
Issued during the year	-	-
<b>Balance as at March 31, 2020</b>	<b>1,83,12,810</b>	<b>183.13</b>
Issued during the year	-	-
<b>Balance as at March 31, 2021</b>	<b>1,83,12,810</b>	<b>183.13</b>
Issued during the period	-	-
<b>Balance as at September 30, 2021</b>	<b>1,83,12,810</b>	<b>183.13</b>

## B Other Equity

Particulars	Attributable to equity shareholders of the Parent								Non-controlling interests	Total
	Other Equity									
	Capital Reserve on Business Combination (Refer Note 49)	Securities Premium	Share options outstanding account	Retained Earnings	Capital Reserve on consolidation	Capital Redemption Reserve	Other comprehensive income	Total Other Equity		
Balance as at April 1, 2018	-	425.27	-	322.60	-	0.02	-	747.89	1.65	749.54
Add / (less) : Impact of Ind AS 116 on account of Scheme of Arrangement (Refer Note 49)	-	-	-	(38.52)	-	-	-	(38.52)	-	(38.52)
Add: Restated Net Loss for the year	-	-	-	(252.55)	-	-	-	(252.55)	8.27	(244.28)
<b>Total Restated Comprehensive Income/(loss) for the year</b>	-	<b>425.27</b>	-	<b>31.53</b>	-	<b>0.02</b>	-	<b>456.82</b>	<b>9.92</b>	<b>466.74</b>
Add: Effect of Scheme of Arrangement	1,201.49	-	-	-	-	-	-	1,201.49	-	1,201.49
Less: Final Dividend	-	-	-	(13.37)	-	-	-	(13.37)	-	(13.37)
Less: Tax on dividend	-	-	-	(2.72)	-	-	-	(2.72)	-	(2.72)
Add: Additions during the period/year (Refer Note 45)	-	-	54.29	-	-	-	-	54.29	-	54.29
<b>Balance as at March 31, 2019</b>	<b>1,201.49</b>	<b>425.27</b>	<b>54.29</b>	<b>15.44</b>	-	<b>0.02</b>	-	<b>1,696.51</b>	<b>9.92</b>	<b>1,706.43</b>
Add/(Less): Restatement Adjustments (Refer Note 4)	74.43	-	-	4.01	19.26	-	-	97.70	-	97.70
<b>Balance as at April 1, 2019</b>	<b>1,275.92</b>	<b>425.27</b>	<b>54.29</b>	<b>19.45</b>	<b>19.26</b>	<b>0.02</b>	-	<b>1,794.21</b>	<b>9.92</b>	<b>1,804.13</b>
Add: Restated Net Loss for the year	-	-	-	(287.31)	-	-	-	(287.31)	(2.08)	(289.39)
Add: Share-based payment expenses (Refer note 45)	-	-	1.22	-	-	-	-	1.22	-	1.22
<b>Balance as at March 31, 2020</b>	<b>1,275.92</b>	<b>425.27</b>	<b>55.51</b>	<b>(267.86)</b>	<b>19.26</b>	<b>0.02</b>	-	<b>1,508.12</b>	<b>7.84</b>	<b>1,515.96</b>
<b>Balance as at April 1, 2020</b>	<b>1,275.92</b>	<b>425.27</b>	<b>55.51</b>	<b>(267.86)</b>	<b>19.26</b>	<b>0.02</b>	-	<b>1,508.12</b>	<b>7.84</b>	<b>1,515.96</b>
Add: Share-based payment expenses (Refer note 45)	-	-	0.01	-	-	-	-	0.01	-	0.01
Add: Restated Net Profit for the year	-	-	-	113.31	-	-	-	113.31	(1.83)	111.48
Add: Restated Other comprehensive income for the year	-	-	-	-	-	-	13.18	13.18	-	13.18
<b>Balance as at March 31, 2021</b>	<b>1,275.92</b>	<b>425.27</b>	<b>55.52</b>	<b>(154.55)</b>	<b>19.26</b>	<b>0.02</b>	<b>13.18</b>	<b>1,634.62</b>	<b>6.01</b>	<b>1,640.63</b>
Add: Share-based payment expenses (Refer note 45)	-	-	0.51	-	-	-	-	0.51	-	0.51
Add: Restated Net Profit for the period	-	-	-	277.80	-	-	-	277.80	1.67	279.47
Less: Final Dividend	-	-	-	(13.74)	-	-	-	(13.74)	-	(13.74)
Add: Restated Other comprehensive income for the period	-	-	-	-	-	-	3.17	3.17	-	3.17
<b>Balance as at September 30, 2021</b>	<b>1,275.92</b>	<b>425.27</b>	<b>56.03</b>	<b>109.51</b>	<b>19.26</b>	<b>0.02</b>	<b>16.35</b>	<b>1,902.36</b>	<b>7.68</b>	<b>1,910.04</b>

\* 0.00 denotes figures are below the rounding off norms adopted by the Group

The accompanying notes 1 to 53 are an integral part of the Restated Consolidated Financial Information

In terms of our report attached

For Deloitte Haskins & Sells  
Chartered AccountantsKartikeya Raval  
PartnerPlace: Ahmedabad  
Date: January 17, 2022

For and on behalf of the Board of Directors

Sanjay Thakker  
Director  
DIN No. 00156093  
Place: Mumbai  
Date: January 17, 2022Paras Somani  
Director  
DIN No. 02742256  
Place: Ahmedabad  
Date: January 17, 2022Surendra Agarwal  
Chief Financial Officer  
Place: Mumbai  
Date: January 17, 2022Amol Raje  
Company Secretary  
Membership No: A19459  
Place: Mumbai  
Date: January 17, 2022

## Restated Consolidated Statement Of Cash Flows

(All amount in INR Millions unless otherwise stated)

Particulars	For the six months period ended	For the year ended		
	September 30, 2021	March 31, 2021	March 31, 2020	March 31, 2019
<b>CASH FLOWS FROM OPERATING ACTIVITIES</b>				
Restated Profit/(Loss) before tax	283.33	197.81	(246.42)	(175.52)
Adjustments for :				
Depreciation and amortisation expense	310.99	624.77	629.52	534.16
Finance costs	182.21	378.05	448.85	527.63
Interest income	(25.58)	(50.62)	(35.58)	(15.67)
Sundry balances written back (Net)	(11.96)	(31.49)	(39.20)	(28.32)
Excess provision written back	(5.33)	(0.37)	(3.18)	-
Bad debts written off	1.44	5.05	9.30	4.66
Provision for doubtful debts	0.74	1.70	0.64	21.04
Share based payment expense	0.51	0.01	1.22	54.29
Loss on sale of property, plant and equipment (Net)	5.02	39.97	39.99	12.54
Gain on termination of lease	(11.39)	-	-	-
Gain on sale of current investments	-	(0.48)	-	-
<b>OPERATING PROFIT BEFORE WORKING CAPITAL CHANGES</b>	<b>729.98</b>	<b>1,164.40</b>	<b>805.14</b>	<b>934.81</b>
Adjustments for:				
(Increase)/Decrease in Inventories	(554.67)	(630.59)	1,140.34	(151.01)
(Increase)/Decrease in trade receivables	(139.92)	(326.77)	540.35	(195.11)
(Increase)/Decrease in financial assets	(7.17)	37.02	180.16	2.22
Decrease/(Increase) in other assets	71.45	(72.81)	134.88	14.28
Increase/(Decrease) in vehicle floor plan	68.76	(595.41)	(501.06)	23.86
Increase/(Decrease) in trade payables	67.37	478.61	(106.68)	135.62
Increase/(Decrease) in other liabilities	79.90	375.78	(64.60)	(72.14)
<b>CASH GENERATED FROM OPERATIONS</b>	<b>315.70</b>	<b>430.23</b>	<b>2,128.53</b>	<b>692.53</b>
Direct taxes paid (net)	(133.18)	(2.59)	(31.93)	(143.68)
<b>NET CASH GENERATED FROM OPERATING ACTIVITIES</b>	<b>182.52</b>	<b>427.64</b>	<b>2,096.60</b>	<b>548.85</b>
<b>CASH FLOWS FROM INVESTING ACTIVITIES</b>				
Purchase of property, plant and equipment (Including Capital Work-in-progress, other intangible assets, capital advances and capital creditors)	(246.58)	(148.03)	(224.13)	(359.23)
Proceeds from sale of property, plant and equipment	11.47	19.59	41.32	30.64
Purchase of non-current investments	(25.30)	(25.29)	(79.99)	-
Purchase of current investments	-	-	(22.50)	-
Redemption of current investments	-	22.98	-	-
Advance for purchase of non-current investments	-	-	(7.50)	-
Inter-corporate deposits (Net)	167.22	(110.74)	(379.17)	(55.26)
Deposits with bank	(42.40)	(20.60)	(13.02)	(1.91)
Interest received	24.30	41.81	25.86	6.38
<b>NET CASH FLOWS USED IN INVESTING ACTIVITIES</b>	<b>(111.29)</b>	<b>(220.28)</b>	<b>(659.13)</b>	<b>(379.38)</b>
<b>CASH FLOWS FROM FINANCING ACTIVITIES</b>				
Dividend paid	(13.74)	-	-	(15.77)
Dividend tax paid	-	-	-	(3.21)
Finance costs paid	(180.63)	(382.85)	(457.62)	(530.41)
Proceeds from long-term borrowings	50.00	278.89	437.43	470.90
Repayment of long-term borrowings	(17.72)	(309.61)	(383.44)	(312.46)
Proceeds from short-term borrowings	5.74	-	-	-
Repayment of short-term borrowings	(21.51)	-	-	-
(Repayment of) / Proceeds from short-term borrowings (Net) (maturity period less than 3 months)	728.75	321.47	(761.61)	359.09
Repayment of lease liabilities	(185.51)	(241.93)	(317.66)	(243.77)
<b>NET CASH FLOWS GENERATED FROM /(USED IN) FINANCING ACTIVITIES</b>	<b>365.38</b>	<b>(334.03)</b>	<b>(1,482.90)</b>	<b>(275.63)</b>
<b>NET INCREASE /(DECREASE) IN CASH AND CASH EQUIVALENTS</b>	<b>436.61</b>	<b>(126.67)</b>	<b>(45.43)</b>	<b>(106.16)</b>
CASH AND CASH EQUIVALENTS AT THE BEGINNING OF THE YEAR	150.34	277.01	322.44	428.60
<b>CASH AND CASH EQUIVALENTS AT THE END OF THE YEAR / PERIOD (Refer Note 15)</b>	<b>586.95</b>	<b>150.34</b>	<b>277.01</b>	<b>322.44</b>

## Restated Consolidated Statement Of Cash Flows

(All amount in INR Millions unless otherwise stated)

## Notes:

- 1 The Restated Consolidated Statement of Cash Flows has been prepared under the Indirect method as set out in Ind AS 7 - Statement of Cash Flows notified under Section 133 of the Companies Act 2013, read together with Paragraph 7 of the Companies (Indian Accounting Standards) Rules, 2015 (as amended).

## 2 Reconciliation of movements of cash flow from financing activities

Particulars	Amount
<b>Balance as at April 1, 2018</b>	<b>2,365.06</b>
<b>Cash flows from financing activities</b>	
Repayment of borrowings	46.63
Proceeds from borrowings	470.90
Finance costs paid	(530.41)
Repayment of lease liabilities	(243.77)
<b>Total Cash flows from financing activities</b>	<b>(256.65)</b>
<b>Non-cash changes</b>	
Liabilities assumed on account of Scheme of Arrangement	792.98
Additions of Lease Liabilities	692.58
Finance costs	527.63
<b>Balance as at March 31, 2019</b>	<b>4,121.60</b>
Restatement Adjustments (Refer Note 42)	(5.91)
<b>Balance as at April 1, 2019</b>	<b>4,115.69</b>
<b>Cash flows from financing activities</b>	
Repayment of borrowings	(1,145.05)
Proceeds from borrowings	437.43
Finance costs paid	(457.62)
Repayment of lease liabilities	(317.66)
<b>Total Cash flows from financing activities</b>	<b>(1,482.90)</b>
<b>Non-cash changes</b>	
Additions of Lease Liabilities	209.03
Finance costs	448.85
<b>Balance as at March 31, 2020</b>	<b>3,290.67</b>
<b>Cash flows from financing activities</b>	
Repayment of borrowings	(309.61)
Proceeds from borrowings	600.36
Finance costs paid	(382.85)
Repayment of lease liabilities	(241.93)
<b>Total Cash flows from financing activities</b>	<b>(334.03)</b>
<b>Non cash changes</b>	
Additions of Lease Liabilities	130.10
Finance costs	378.05
<b>Balance as at March 31, 2021</b>	<b>3,464.79</b>
<b>Cash flows from financing activities</b>	
Repayment of borrowings	(39.23)
Proceeds from borrowings	784.49
Finance costs paid	(180.63)
Repayment of lease liabilities	(185.51)
<b>Total Cash flows from financing activities</b>	<b>379.12</b>
<b>Non cash changes</b>	
Additions of Lease Liabilities	167.86
Deletions of Lease Liabilities	(48.26)
Finance costs	182.21
<b>Balance as at September 30, 2021</b>	<b>4,145.72</b>

The accompanying notes 1 to 53 are an integral part of the Restated Consolidated Financial Information

In terms of our report attached

**For Deloitte Haskins & Sells**  
Chartered Accountants  
Firm's Registration Number: 117365W

For and on behalf of the Board of Directors

**Kartikeya Raval**  
Partner  
  
Place : Ahmedabad  
Date: January 17, 2022

**Sanjay Thakker**  
Director  
DIN No. 00156093  
Place: Mumbai  
Date: January 17, 2022

**Paras Somani**  
Director  
DIN No. 02742256  
Place: Ahmedabad  
Date: January 17, 2022

**Surendra Agarwal**  
Chief Financial Officer  
  
Place: Mumbai  
Date: January 17, 2022

**Amol Raje**  
Company Secretary  
Membership No: A19459  
Place: Mumbai  
Date: January 17, 2022

**1 Corporate information**

Landmark Cars Limited (formerly known as Landmark Cars Private Limited) ("the Company" or "the Parent") together with its subsidiaries (collectively referred to as "the Group") are authorised dealers of passenger car brands of Mercedes-Benz, Honda, Ashok Leyland, Volkswagen, Renault, Fiat, Jeep and Nissan (up to August, 2020). The Group has business operations mainly in the states of Gujarat, Madhya Pradesh, Maharashtra, Delhi, Punjab, Haryana and West Bengal. The Group is engaged in the business of (i) operation of showrooms to buy and sell automobiles of above mentioned brands (ii) the operation of workshops and garages to repair and service the automobiles (iii) direct selling agency/marketing agency on behalf of inter alia banks and non-banking financial companies to market their financing schemes to customers (iv) selling of accessories provided by the OEM's (v) the insurance commission business in connection with (i) and (ii).

The Company has converted from a Private Limited Company to a Public Limited Company, pursuant to a special resolution passed in the extraordinary general meeting of the shareholders of the Company held on November 10, 2021 and consequently the name of the Company has changed to Landmark Cars Limited pursuant to a fresh certificate of incorporation issued by ROC on December 03, 2021.

The Company is incorporated and domiciled in India under the provisions of the Companies Act applicable in India. The registered office of the Parent is located at Landmark House, Opp AEC, S.G. Highway Thaltej, Near Gurudwara, Ahmedabad - 380059, Gujarat, India.

The Group's restated consolidated financial information for the six months period ended September 30, 2021 and for the years ended March 31, 2021, March 31, 2020, and 31 March 2019 were authorized by Board of Directors on January 17, 2022.

**2 Basis of preparation and presentation of restated consolidated financial information**

**2.1 Basis of preparation and statement of compliance**

The Restated Consolidated Financial Information of the Group comprise of the Restated Consolidated Statement of Assets and Liabilities as at September 30, 2021, March 31, 2021, March 31, 2020, and March 31, 2019, the Restated Consolidated Statements of Profit and Loss (including Other Comprehensive Income), the Restated Consolidated Statements of Changes in Equity and the Restated Consolidated Statements of Cash Flows for the six months period ended September 30, 2021 and for the years ended March 31, 2021, March 31, 2020 and March 31, 2019 and the Summary of Significant Accounting Policies and explanatory notes (collectively, the 'Restated Consolidated Financial Information').

These Restated Consolidated Financial Information have been prepared by the Management of the Group for the purpose of inclusion in the Draft Red Herring Prospectus ('DRHP') to be filed by the Company with the Securities and Exchange Board of India ("SEBI"), National Stock Exchange of India Limited and BSE Limited in connection with proposed Initial Public Offering ("IPO") of its equity shares of the Company comprising of fresh issue of equity shares and an offer for sale of equity shares held by the selling shareholders (the "Offer").

The Restated Consolidated Financial Information, which have been approved by the Board of Directors of the Company, have been prepared in accordance with the requirements of :

- (a) Section 26 of Part I of Chapter III of the Companies Act, 2013, as amended ("the Act");
- (b) The Securities and Exchange Board of India (Issue of Capital and Disclosure Requirements) Regulations, 2018 ("ICDR") as amended from time to time; and
- (c) The Guidance Note on Reports in Company Prospectuses (Revised 2019) issued by the Institute of Chartered Accountants of India (ICAI) as amended (the "Guidance Note") read with the general directions dated October 28, 2021 received from Securities and Exchange Board of India (SEBI) by the Company through Lead Managers (the "SEBI Communication"), as applicable.

In accordance with the notification dated February 16, 2015, issued by Ministry of Corporate Affairs, the Company has voluntarily adopted Indian Accounting Standards notified under section 133 of the Companies Act, 2013 (the "Act") read with the Companies (Indian Accounting Standards) Rules, 2015, as amended ("Ind AS") with transition date from April 1, 2019.

These Restated Consolidated Financial Information have been compiled from:

- a) The audited Special Purpose Consolidated Interim Financial Statements of the Group as at and for the six months period ended September 30, 2021 which is prepared in accordance with the recognition and measurement principles of Indian Accounting Standard 34 "Interim Financial Reporting" ("Ind AS 34") as prescribed under Section 133 of the Act read with relevant rules thereunder and other accounting principles generally accepted in India (the "Special Purpose Consolidated Interim Financial Statements"), which have been approved by the Board of Directors at their meeting held on January 17, 2022;
- b) The audited Consolidated Ind AS financial statements of the Group as at and for the year ended March 31, 2021 along with comparative audited consolidated Ind AS financial statements for the year ended March 31, 2020 (the "Statutory Consolidated Ind AS Financial Statements") which have been approved by the Board of Directors at their meeting held on July 23, 2021. The comparative information as at and for the year ended March 31, 2020 included in such Consolidated Ind AS Financial Statements have been prepared by making Ind AS adjustments to the audited consolidated Indian GAAP financial statements of the Group as at and for the year ended March 31, 2020, prepared in accordance with the accounting standards notified under the Section 133 of the Act ("Indian GAAP") which was approved by the Board of directors at their meeting held on December 31, 2020.
- c) The Company has prepared the Special Purpose Consolidated Ind AS Financial Statements as at and for the year ended March 31, 2019 (the "Special Purpose Consolidated Ind AS Financial Statements") as per following basis, which have been approved by the Board of Directors at their meeting held on January 17, 2022.

In pursuance to the SEBI Communication, for the purpose of Special Purpose Consolidated Ind AS Financial Statements of the Group as at and for the year ended March 31, 2019, the transition date is considered as April 1, 2018 which is different from the transition date adopted by the Group at the time of first time transition to Ind AS (i.e. April 1, 2019) for the purpose of preparation of Statutory Consolidated Ind AS Financial Statements as required under Companies Act, 2013, as amended. Accordingly, the Group has applied the accounting policy choices (both mandatory exceptions and optional exemptions availed as per Ind AS 101) as on April 1, 2018 for these Special Purpose Consolidated Ind AS Financial Statements.

**Landmark Cars Limited (formerly known as Landmark Cars Private Limited)**  
**Significant Accounting Policies to the Restated Consolidated Financial Information**  
(All amount in INR Millions unless otherwise stated)

As such, the financial statements for the year ended March 31, 2019 are Special Purpose Consolidated Ind AS Financial Statements of the Group prepared considering the accounting principles stated in Ind AS, as adopted by the Group and described below. These Special Purpose Consolidated Ind AS Financial Statements have been prepared solely for the purpose of preparation of Restated Consolidated Financial Information for inclusion in Offer Documents in relation to the proposed IPO, which requires three years financial statements to be presented under Ind AS. As such, these Special Purpose Consolidated Ind AS Financial Statements are not suitable for any other purpose other than for the purpose of preparation of Restated Consolidated Financial Information, and are also not financial statements prepared pursuant to any requirements under section 129 of the Companies Act, 2013, as amended. Further, since the statutory date of transition to Ind AS is April 1, 2019, and these Special Purpose Consolidated Ind AS Financial Statements have been prepared considering a transition date of April 1, 2018, the closing balances of items included in the Balance Sheet as at March 31, 2019 may be different from the balances considered on the statutory date of transition to Ind AS on April 1, 2019, due to such early application of Ind AS principles with effect from April 1, 2018 as compared to the date of statutory transition. Refer Note 4 for reconciliation of equity and total comprehensive income as per the Special Purpose Consolidated Interim Financial Statements, Statutory Consolidated Ind AS Financial Statements, Statutory Indian GAAP Financial Statements (as defined below) and equity and total comprehensive income as per restated consolidated financial information.

The above Special Purpose Consolidated Ind AS Financial Statements have been prepared by making Ind AS adjustments as mentioned above to the audited consolidated Indian GAAP financial statements of the Group as at and for the year ended March 31, 2019 prepared in accordance with Indian GAAP (the "Statutory Indian GAAP Financial Statements") which was approved by the Board of directors at their meeting held on September 30, 2019.

The Restated Consolidated Financial Information:

- (a) have been prepared after incorporating adjustments for the changes in accounting policies, material errors and regrouping/reclassifications retrospectively in the financial year ended March 31, 2021 and March 31, 2020 to reflect the same accounting treatment as per the accounting policies and grouping/classifications followed as at and for the six months period ended September 30, 2021;
- (b) do not require any adjustment for modification as there is no modification in the underlying audit reports;

These Restated Consolidated Financial Information do not reflect the effects of events that occurred subsequent to the respective dates of the board meetings for adoption of Special Purpose Consolidated Interim Financial Statements, Statutory Consolidated Ind AS Financial Statements and the Statutory Indian GAAP Financial Statements.

These Restated Consolidated Financial Information have been prepared for the Group as a going concern basis.

The accounting policies have been consistently applied by the Company in preparation of the Restated Consolidated Financial Information and are consistent with those adopted in the preparation of financial statements for the six months period ended September 30, 2021.

## **2.2 Principles of Consolidation**

The Restated Consolidated Financial Information comprise the financial statements of the Parent and its subsidiaries for the six months period ended September 30, 2021 and for the years ended March 31, 2021, March 31, 2020 and March 31, 2019.

The Company controls an entity when it is exposed, or has rights, to variable returns from its involvement with the entity and has the ability to affect those returns through its power over the entity. Power is demonstrated through existing rights that give the current ability to direct the relevant activities of the entity that significantly affect the entity's returns.

Control is achieved when the Group is exposed, or has rights, to variable returns from its involvement with the investee and has the ability to affect those returns through its power over the investee. Specifically, the Group controls an investee if and only if the Group has:

- Power over the investee (i.e. existing rights that give it the current ability to direct the relevant activities of the investee),
- Exposure, or rights, to variable returns from its involvement with the investee, and
- The ability to use its power over the investee to affect its returns.

The Company re-assesses whether or not it controls an investee if facts and circumstances indicate that there are changes to one or more of the three elements of control.

Generally, there is a presumption that a majority of voting rights result in control. To support this presumption and when the Group has less than a majority of the voting or similar rights of an investee, the Group considers all relevant facts and circumstances in assessing whether it has power over an investee, including:

- The contractual arrangement with the other vote holders of the investee
- Rights arising from other contractual arrangements
- The Group's voting rights and potential voting rights
- The size of the Group's holding of voting rights relative to the size and dispersion of the holdings of the other voting rights holders

Consolidation of a subsidiary begins when the Group obtains control over the subsidiary and ceases when the Group loses control of the subsidiary. Assets, liabilities, income and expenses of a subsidiary acquired or disposed of during the year are included in the restated consolidated financial information from the date the Group gains control until the date the Group ceases to control the subsidiary.

The Restated Consolidated financial information are prepared using uniform accounting policies for like transactions and other events in similar circumstances. If a member of the group uses accounting policies other than those adopted in the consolidated financial information for like transactions and events in similar circumstances, appropriate adjustments are made to that group member's financial information in preparing the consolidated financial information to ensure conformity with the group's accounting policies.

The restated consolidated financial information of all entities used for the purpose of consolidation are drawn up to same reporting date as that of the parent company i.e. for the six months period ended September 30, 2021 and for the years ended March 31, 2021, March 31, 2020 and March 31, 2019.

**Landmark Cars Limited (formerly known as Landmark Cars Private Limited)**  
**Significant Accounting Policies to the Restated Consolidated Financial Information**  
 (All amount in INR Millions unless otherwise stated)

**Consolidation procedure:**

- (a) Combine like items of assets, liabilities, equity, income, expenses and cash flows of the parent with those of its subsidiaries.
- (b) Offset (eliminate) the carrying amount of the parent's investment in each subsidiary and the parent's portion of equity of each subsidiary. Business combinations policy explains how to account for any related goodwill.
- (c) Eliminate in full intragroup assets and liabilities, equity, income, expenses and cash flows relating to transactions between entities of the group (profits or losses resulting from intragroup transactions that are recognised in assets, such as inventory and property, plant and equipment, are eliminated in full). Intragroup losses may indicate an impairment that requires recognition in the consolidated financial statements. Ind AS 12 Income Taxes applies to temporary differences that arise from the elimination of profits and losses resulting from intragroup transactions.

Restated Consolidated Statement of profit and loss and each component of other comprehensive income (OCI) are attributed to the equity holders of the parent of the Group and to the non-controlling interests, even if this results in the non-controlling interests having a deficit balance. When necessary, adjustments are made to the statements of subsidiaries to bring their accounting policies into line with the Group's accounting policies. All intra-group assets and liabilities, equity, income, expenses and cash flows relating to transactions between members of the Group are eliminated in full on consolidation.

Non-controlling interests in subsidiaries are identified separately from the Group's equity therein. Those interests of non-controlling shareholders that are present ownership interests entitling their holders to a proportionate share of net assets upon liquidation may initially be measured at fair value or at the non-controlling interests' proportionate share of the fair value of the acquiree's identifiable net assets. The choice of measurement is made on an acquisition-by-acquisition basis. Other non-controlling interests are initially measured at fair value. Subsequent to acquisition, the carrying amount of non-controlling interests is the amount of those interests at initial recognition plus the non-controlling interests' share of subsequent changes in equity.

Profit or loss and each component of other comprehensive income are attributed to the owners of the Company and to the non-controlling interests. Total comprehensive income of the subsidiaries is attributed to the owners of the Company and to the non-controlling interests even if this results in the non-controlling interests having a deficit balance.

Changes in the Group's interests in subsidiaries that do not result in a loss of control are accounted for as equity transactions. The carrying amount of the Group's interests and the non-controlling interests are adjusted to reflect the changes in their relative interests in the subsidiaries. Any difference between the amount by which the non-controlling interests are adjusted and the fair value of the consideration paid or received is recognised directly in equity and attributed to the owners of the Company.

When the Group loses control of a subsidiary, the gain or loss on disposal recognised in profit or loss is calculated as the difference between (i) the aggregate of the fair value of the consideration received and the fair value of any retained interest and (ii) the previous carrying amount of the assets (including goodwill), less liabilities of the subsidiary and any non-controlling interests. All amounts previously recognised in other comprehensive income in relation to that subsidiary are accounted for as if the Group had directly disposed of the related assets or liabilities of the subsidiary (i.e. reclassified to profit or loss or transferred to another category of equity as required/permitted by applicable Ind AS's). The fair value of any investment retained in the former subsidiary at the date when control is lost is regarded as the fair value on initial recognition for subsequent accounting under Ind AS 109 when applicable, or the cost of initial recognition of an investment in an associate or a joint venture.

Following subsidiary companies, which are incorporated in India, have been considered in the preparation of consolidated financial information.

Name of the Subsidiaries	% of Holding			
	As at September 30, 2021	As at March 31, 2021	As at March 31, 2020	As at March 31, 2019
Landmark Cars (East) Private Limited	83%	83%	83%	83%
Landmark Lifestyle Cars Private Limited	100%	100%	100%	100%
Benchmark Motors Private Limited	100%	100%	100%	100%
Watermark Cars Private Limited	100%	100%	100%	100%
Landmark Automobiles Private Limited	100%	100%	100%	100%
Automark Motors Private Limited	100%	100%	100%	100%
Landmark Commercial Vehicles Private Limited	100%	100%	100%	100%

**Basis of Measurement**

The Restated Consolidated Financial Information have been prepared on accrual and going concern basis under the historical cost convention except for certain class of financial assets/ liabilities and share based payments that are measured at fair value. The accounting policies have been consistently applied by the Group unless otherwise stated.

**Functional and Presentation Currency**

The Restated Consolidated Financial Information have been prepared and presented in Indian Rupees (INR), which is also the Group's functional currency.

#### **Rounding off**

All amounts disclosed in the Restated Consolidated Financial Information and notes have been rounded off to the nearest Millions, unless otherwise stated.

#### **Key accounting estimates and judgement:**

The preparation of Restated Consolidated Financial Information requires management to make judgments, estimates and assumptions in the application of accounting policies that affect the reported amounts of assets, liabilities, income and expenses. Actual results may differ from these estimates. Continuous evaluation is done on the estimation and judgments based on historical experience and other factors, including expectations of future events that are believed to be reasonable. Revisions to accounting estimates are recognised prospectively.

Information about critical judgments in applying accounting policies, as well as estimates and assumptions that have the most significant effect to the carrying amounts of assets and liabilities within the next financial year, are included in the following notes:

##### **(i) Impairment of financial assets:**

The impairment provision for financial assets are based on assumptions about risk of default and expected loss rates. The Group uses judgement in making these assumptions and selecting the inputs to the impairment calculation, based on Group's past history, existing market conditions as well as forward looking estimates at the end of each reporting period.

##### **(ii) Taxation:**

Deferred tax, subject to the consideration of prudence, is recognised on temporary differences between the taxable income and accounting income that originate in one period and are capable of reversal in one or more subsequent periods. Deferred tax assets are recognised to the extent that there is reasonable certainty that sufficient future tax income will be available against which such deferred tax assets can be realized.

##### **(iii) Share based payment:**

Employees of the Group with a pre defined grade is granted options to purchase equity shares. Each share option converts into one equity share of the Group on exercise. In accordance with the Ind AS 102 Share Based Payments, the cost of equity settled transactions is measured using the fair value method. The cumulative expense recognized for equity-settled transactions at each reporting date until the vesting date reflects the extent to which the vesting period has expired and the Group's best estimate of the number of equity instruments that will ultimately vest. The expense or credit recognized in the statement of profit and loss for a period represents the movement in cumulative expense recognized as at the beginning of the year and end of that period and is recognized in employee benefits expense.

##### **(iv) Fair Value Measurement:**

Fair value is the price that would be received to sell an asset or paid to transfer a liability in an orderly transaction between market participants at the measurement date. The Group's accounting policies require, measurement of certain financial / non-financial assets and liabilities at fair values (either on a recurring or non-recurring basis). Also, the fair values of financial instruments measured at amortised cost are required to be disclosed in the said Restated Consolidated Financial Information.

The Group is required to classify the fair valuation method of the financial / non-financial assets and liabilities, either measured or disclosed at fair value in the standalone financial statements, using a three level fair-value-hierarchy (which reflects the significance of inputs used in the measurement). Accordingly, the Group uses valuation techniques that are appropriate in the circumstances and for which sufficient data are available to measure fair value, maximising the use of relevant observable inputs and minimising the use of unobservable inputs.

The three levels of the fair-value-hierarchy are described below:

Level 1 – Quoted (unadjusted) market prices in active markets for identical assets or liabilities

Level 2 – Valuation techniques for which the lowest level input that is significant to the fair value measurement is directly or indirectly observable

Level 3 – Valuation techniques for which the lowest level input that is significant to the fair value measurement is unobservable

### **2.3 Revenue Recognition**

#### **Revenue from operations**

Revenue from contracts with customers is recognized on transfer of control of promised goods or services to a customer at an amount that reflects the consideration to which the Group is expected to be entitled to in exchange for those goods or services.

Revenue towards satisfaction of a performance obligation is measured at the amount of transaction price (net of variable consideration) allocated to that performance obligation. The transaction price of goods sold and services rendered is net of variable consideration on account of various discounts and schemes offered by the Group as part of the contract.

This variable consideration is estimated based on the expected value of outflow. Revenue (net of variable consideration) is recognized only to the extent that it is highly probable that the amount will not be subject to significant reversal when uncertainty relating to its recognition is resolved.

##### **Sale of products:**

Revenue from sale of products is recognized when the control on the goods have been transferred to the customer. The performance obligation in case of sale of product is satisfied at a point in time i.e., when the material is dispatched to the customer or on delivery to the customer, as may be specified in the contract.

##### **Rendering of services:**

Revenue from services is recognized over time by measuring progress towards satisfaction of performance obligation for the services rendered. The Group uses output method for measurement of revenue from rendering of services based on time elapsed and / or parts delivered.



**Revenue from other operating income**

The other operating revenue includes commission income and claims from suppliers. The performance obligation for other operating revenue is satisfied at point in time.

**Other revenue**

Interest income is recognised using effective interest method. The effective interest rate is the rate that exactly discounts estimated future cash receipts through expected life of the financial asset to the gross carrying amount of the financial asset. When calculating the effective interest rate, the Group estimates the expected cash flows by considering all the contractual terms of the financial instrument but does not consider the expected credit losses.

All other incomes are recognised and accounted for on accrual basis.

**2.4 Property, Plant and Equipment**

Property, Plant and Equipment are stated at cost, net of accumulated depreciation and accumulated impairment losses, if any.

The cost comprises the purchase price, borrowing cost if capitalization criteria are met and directly attributable cost of bringing the asset to its working condition for its intended use. Any trade discounts and rebates are deducted in arriving at the purchase price.

Subsequent expenditures relating to property, plant and equipment is capitalized only when it is probable that future economic benefits associated with these will flow to the Group and the cost of the item can be measured reliably.

All other expenses on existing property, plant and equipment, including day-to-day repair and maintenance expenditure and cost of replacing parts, are charged to the restated consolidated statement of profit and loss for the period during which such expenses are incurred.

Property, Plant and Equipment not ready for the intended use on the date of the restated consolidated statement of assets and liabilities are disclosed as "Capital work-in-progress".

Gains or losses arising from derecognition of fixed assets are measured as the difference between the net disposal proceeds and the carrying amount of the asset at the time of disposal and are recognized in the restated consolidated statement of profit and loss when the asset is derecognized.

Depreciation on Property, Plant and Equipment is calculated on the straight-line method as per the useful life prescribed in Schedule II to the Companies Act, 2013.

Leasehold improvements are amortized over the period of lease. Residual value of the leasehold improvements are considered as 5% of cost except in case of steel used as the Company and one of its subsidiary company is expected to receive residual value at 50% of cost at the end of its lease period.

In respect of Property, Plant and Equipment purchased during the year, depreciation is provided on a pro-rata basis from the date on which such asset is ready to use.

The residual value, useful live and method of depreciation of Property, Plant and Equipment are reviewed at each reporting period end and adjusted prospectively, if appropriate.

**2.5 Intangible assets**

An intangible asset is recognised, only where it is probable that future economic benefits attributable to the asset will accrue to the enterprise and the cost can be measured reliably.

Intangible assets acquired separately are measured on initial recognition at cost. Intangible assets arising on acquisition of business are measured at fair value as at date of acquisition. Internally generated intangibles including research cost are not capitalized and the related expenditure is recognized in the restated consolidated statement of profit and loss in the period in which the expenditure is incurred. Following initial recognition, intangible assets are carried at cost less accumulated amortization and accumulated impairment loss, if any.

Intangible assets not ready for the intended use on the date of the restated consolidated statement of assets and liabilities are disclosed as intangible assets under development.

The useful lives of intangible assets are assessed as either finite or indefinite. Finite-life intangible assets are amortized on a straight-line basis over the period of their expected useful lives. Intangible assets acquired / purchased during the year are amortised on a pro-rata basis from the date on which such assets are ready to use.

Customer relationship acquired in business combination are amortised over a period of 5 years on straight line basis.

Intangible assets with an indefinite useful life are not amortised. Such intangible assets are tested for impairment.

The residual value, useful live and method of amortization of intangible assets are reviewed at each reporting period end and adjusted prospectively, if appropriate.

**2.6 Financial Instruments**

**Initial recognition**

The Group recognizes financial assets and financial liabilities when it becomes a party to the contractual provisions of the instrument.

All financial assets and liabilities are recognized at fair value on initial recognition.

Transaction costs that are directly attributable to the acquisition or issue of financial assets and financial liabilities that are not at fair value through profit or loss are added to or deducted from the fair value of financial assets or financial liabilities on initial recognition.

Transaction costs directly attributable to the acquisition of financial assets or financial liabilities at fair value through profit or loss are recognised immediately in Restated Consolidated Statement of Profit and Loss.

**Subsequent measurement**

**Non-derivative financial instruments**

**Financial assets carried at amortized cost**

A financial asset is subsequently measured at amortized cost if it is held within a business model whose objective is to hold the asset in order to collect contractual cash flows and the contractual terms of the financial asset give rise on specified dates to cash flows that are solely payments of principal and interest on the principal amount outstanding.

**Financial assets at fair value through other comprehensive income (FVTOCI)**

A financial asset is subsequently measured at fair value through other comprehensive income if it is held within a business model whose objective is achieved by both collecting contractual cash flows and selling financial assets and the contractual terms of the financial asset give rise on specified dates to cash flows that are solely payments of principal and interest on the principal amount outstanding.

The Group has made an irrevocable election for its investments which are classified as equity instruments to present the subsequent changes in fair value in other comprehensive income based on its business model. For such equity instruments, the subsequent changes in fair value are recognized in the restated other comprehensive income in the restated consolidated statement of profit and loss.

**Financial assets at fair value through profit or loss (FVTPL)**

A financial asset which is not classified in any of the above categories are subsequently measured at fair valued through profit or loss. Fair value changes are recognised as other income in the restated consolidated statement of profit or loss.

Based on the Group's business model, the Group has classified its Investment in Mutual Funds at FVTPL.

**Derecognition of financial assets**

The Group derecognises a financial asset when the contractual rights to the cash flows from the financial asset expire, or it transfers the rights to receive the contractual cash flows in a transaction in which substantially all of the risks and rewards of ownership of the financial asset are transferred or in which the Group neither transfers nor retains substantially all of the risks and rewards of ownership and does not retain control of the financial asset.

On derecognition of a financial asset in its entirety, the difference between the asset's carrying amount and the sum of the consideration received and receivable and the cumulative gain or loss that had been recognised in other comprehensive income and accumulated in equity is recognised in the Restated Consolidated Statement of Profit and Loss if such gain or loss would have otherwise been recognised in the Restated Consolidated Statement of Profit and Loss on disposal of that financial asset.

**Financial liabilities at Fair Value through Profit or Loss (FVTPL)**

A financial liability may be designated as at FVTPL upon initial recognition if:

- (a) such designation eliminates or significantly reduces a measurement or recognition inconsistency that would otherwise arise;
- (b) The financial liability whose performance is evaluated on a fair value basis, in accordance with the Group's documented risk management;

Financial liabilities at FVTPL are stated at fair value, with any gains or losses arising on remeasurement recognised in the Statement of Profit and Loss. The net gain or loss recognised in profit or loss incorporates any interest paid on the financial liability.

**Financial liabilities at amortised cost**

Financial liabilities that are not held for trading and are not designated as at FVTPL are measured at amortised cost at the end of subsequent accounting periods. The carrying amounts of financial liabilities that are subsequently measured at amortised cost are determined based on the effective interest method. Interest expense that is not capitalised as part of costs of an asset is included in the 'Finance costs' line item.

The effective interest method of calculating the amortised cost of a financial liability and of allocating interest expense over the relevant period.

The effective interest rate is the rate that exactly discounts estimated future cash payments (including all fees and points paid or received that form an integral part of the effective interest rate, transaction costs and other premiums or discounts) through the expected life of the financial liability, or (where appropriate) a shorter period, to the net carrying amount on initial recognition.

Trade and other payables are recognised at the transaction cost, which is its fair value, and subsequently measured at amortised cost.

**Derecognition of Financial Liabilities**

The Group derecognises financial liabilities when, and only when, the Group's obligations are discharged, cancelled or have expired. An exchange with a lender of debt instruments with substantially different terms is accounted for as an extinguishment of the original financial liability and the recognition of a new financial liability. Similarly, a substantial modification of the terms of an existing financial liability is accounted for as an extinguishment of the original financial liability and the recognition of a new financial liability. The difference between the carrying amount of the financial liability derecognised and the consideration paid and payable is recognised in the Restated Consolidated Statement of Profit and Loss.

**Off-setting of financial assets and financial liabilities**

Financial assets and liabilities are offset when the Group currently has a legally enforceable right to offset the recognised amount and intends either to settle on a net basis or to realize the asset and settle the liability simultaneously.

**Modification**

A modification of a financial asset or liabilities occurs when the contractual terms governing the cash flows of a financial asset or liabilities are renegotiated or otherwise modified between initial recognition and maturity of the financial instruments. Any gain/ loss on modification is charged to restated consolidated statement of profit and loss.

## **2.7 Taxes**

Tax expense comprises current income tax and deferred tax.

### **Current Income Tax**

Current income tax assets and liabilities are measured at the amount expected to be recovered from or paid to the taxation authorities. Current income tax (including Minimum Alternate Tax ("MAT")) is measured at the amount expected to be paid to the tax authorities in accordance with the Income-Tax Act, 1961 enacted in India. The tax rates and tax laws used to compute the amount are those that are enacted or substantially enacted, at the reporting date.

Current income tax relating to items recognised outside the restated consolidated statement of profit and loss is recognised outside the restated consolidated statement of profit and loss (either in other comprehensive income or in equity). Current tax items are recognised in correlation to the underlying transaction either in OCI or directly in equity. Management periodically evaluates positions taken in the tax returns with respect to situations in which applicable tax regulations are subject to interpretation and establishes provisions where appropriate.

### **Deferred Tax**

Deferred tax is provided using the balance-sheet approach on temporary differences between the tax bases of assets and liabilities and their carrying amounts for financial reporting purposes at the reporting date.

Deferred tax liabilities are recognised for all taxable temporary differences, except to the extent that the deferred tax liability arises from initial recognition of goodwill; or an asset or liability in a transaction which is not a business combination and at the time of transaction, affects neither accounting profit nor taxable profit or loss.

Deferred tax assets are recognised for all deductible temporary differences, the carry forward of unused tax credits and any unused tax losses to the extent that it is probable that taxable profit will be available against which the deductible temporary differences and the carry forward of unused tax credits and unused tax losses can be utilized except when the deferred tax asset relating to the deductible temporary difference arises from the initial recognition of an asset or liability in a transaction that is not a business combination and at the time of the transaction, affects neither accounting profit nor taxable profit or loss.

The carrying amount of deferred tax assets is reviewed at each reporting date and reduced to the extent that it is no longer probable that sufficient future taxable profit will be available to allow all or part of the deferred tax asset to be utilised. Unrecognised deferred tax assets are re-assessed at each reporting date and are recognised to the extent that it has become probable that future taxable profits will allow the deferred tax asset to be recovered.

Deferred tax assets and liabilities are measured at the tax rates that are expected to apply to the period when the asset is realized or the liability is settled, based on the tax rates (and tax laws) that have been enacted or substantively enacted at the reporting date.

Deferred tax assets include Minimum Alternate Tax (MAT) credit paid in accordance with the tax laws in India, which is likely to give future economic benefits in the form of availability of set off against future income tax liability. Accordingly, MAT credit is recognized as deferred tax asset in the Balance sheet when the asset can be measured reliably and it is probable that the future economic benefit associated with the asset will be realised.

Deferred tax relating to items recognised outside the restated consolidated statement of profit and loss is recognised outside the restated consolidated statement of profit and loss (either in other comprehensive income or in equity). Deferred tax items are recognised in correlation to the underlying transaction either in OCI or directly in equity.

Deferred tax assets and deferred tax liabilities are offset, if a legally enforceable right exists to set off current tax assets against current tax liabilities and the deferred taxes relate to the same taxable entity and the same taxation authority.

## **2.8 Impairment**

### **Financial assets**

The Group recognizes loss allowances using the expected credit loss (ECL) model for the financial assets which are not fair valued through profit or loss.

Loss allowance for trade receivables with no significant financing component is measured at an amount equal to lifetime ECL.

For all other financial assets, expected credit losses are measured at an amount equal to the 12-month ECL, unless there has been a significant increase in credit risk from initial recognition in which case those are measured at lifetime ECL.

The impairment loss allowance (or reversal) recognised during the period is recognised as income / expense in the restated consolidated statement of profit and loss.

### **Non-financial assets**

#### **Tangible and intangible assets**

The Group assesses at each reporting date whether there is an indication that an asset may be impaired. If any indication exists the Group estimates the asset's recoverable amount.

An asset's recoverable amount is the higher of an asset's net selling price and its value in use. The recoverable amount is determined for an individual asset, unless the asset does not generate cash inflows that are largely independent of those from other assets or groups of assets.

Where the carrying amount of an asset exceeds its recoverable amount, the asset is considered impaired and is written down to its recoverable amount. The impairment loss is recognised in the restated consolidated statement of profit and loss.

In assessing value in use, the estimated future cash flows are discounted to their present value using a pre-tax discount rate that reflects current market assessments of the time value of money and the risks specific to the asset.

In determining net selling price, recent market transactions are taken into account, if available. If no such transactions can be identified, an appropriate valuation model is used.

**2.9 Lease**

**Group as lessee**

The Group's lease asset classes primarily consist of leases for showrooms, workshops and stockyards. The Group assesses whether a contract contains a lease, at inception of a contract. A contract is, or contains, a lease if the contract conveys the right to control the use of an identified asset for a period of time in exchange for consideration. To assess whether a contract conveys the right to control the use of an identified asset, the Group assesses whether: (i) the contract involves the use of an identified asset (ii) the Group has substantially all of the economic benefits from use of the asset through the period of the lease and (iii) the Group has the right to direct the use of the asset.

At the date of commencement of the lease, the Group recognizes a right-of-use (ROU) asset and a corresponding lease liability for all lease arrangements in which it is a lessee, except for leases with a term of 12 months or less (short-term leases) and low value leases. For these short-term and low-value leases, the Group recognizes the lease payments as an operating expense on a straight-line basis over the term of the lease.

The ROU assets are initially recognized at cost, which comprises the initial amount of the lease liability adjusted for any lease payments made at or prior to the commencement date of the lease plus any initial direct costs less any lease incentives. They are subsequently measured at cost less accumulated amortisation and impairment losses.

ROU assets are depreciated from the commencement date on a straight-line basis over the shorter of the lease term and useful life of the underlying asset.

The lease liability is initially measured at amortized cost at the present value of the future lease payments. The lease payments are discounted using the interest rate implicit in the lease or, if not readily determinable, using the incremental borrowing rates in the country of domicile of these leases.

Lease liability and ROU assets have been separately presented in the restated consolidated statement of assets and liabilities and lease payments have been classified as financing cash flows.

**2.10 Borrowing costs**

Borrowing cost includes interest and other costs that Group has incurred in connection with the borrowing of funds.

Borrowing costs directly attributable to the acquisition, construction or production of an asset that necessarily takes a substantial period of time to get ready for its intended use or sale are capitalized as part of the cost of the respective asset.

All other borrowing costs are expensed in the year they occur.

Investment income earned on temporary investment of specific borrowing pending their expenditure on qualifying assets is deducted from the borrowing costs eligible for capitalization.

**2.11 Employee Benefits**

**Defined Contribution Plan**

Retirement benefit in the form of provident fund, employees' state insurance fund scheme and Labour welfare scheme is a defined contribution scheme. The Company has no obligation, other than the contribution paid/payable under such schemes. The contribution paid/payable under the schemes is recognised during the period in which the employee renders the related service.

**Defined Benefit Plan**

The Group has provided the benefits of gratuity, a defined benefit plan (the "Gratuity Plan") covering eligible employees in accordance with the Payment of Gratuity Act, 1972. As per the Gratuity Plan, the Group makes monthly payment to their employees with remeasurement option to vested employees at retirement, death, incapacitation or termination of employment, of an amount based on the respective employee's salary and the tenure of employment. The Group's liability is actuarially determined (using the Projected Unit Credit method) at the end of each year. Gratuity which is defined benefit plans is paid per month on the basis of employee's gross salary.

Remeasurements of the net defined benefit liability comprising actuarial gains and losses (excluding amounts included in net interest on the net defined benefit liability), are recognized in Other Comprehensive Income. Such remeasurements are not reclassified to the Restated Consolidated Statement of Profit and Loss in the subsequent periods.

Compensated absences are not to be carried forward beyond 12 months and are paid per month on the basis of the employee's gross salary.

**2.12 Share based payments**

Employees (including senior executives) of the Group receive remuneration in the form of share-based payments, whereby employees render services as consideration for equity instruments (equity-settled transactions).

Equity-settled transactions: The cost of equity-settled transactions is determined by the fair value at the date when the grant is made using an appropriate valuation model.

That cost is recognised, together with a corresponding increase in share-based payment reserves in equity, over the period in which the service conditions are fulfilled in employee benefits expense. The cumulative expense recognised for equity-settled transactions at each reporting date until the vesting date reflects the extent to which the vesting period has expired and Group's best estimate of the number of equity instruments that will ultimately vest. The expense or credit in the restated consolidated statement of profit and loss for a period represents the movement in cumulative expense recognised as at the beginning and end of that period and is recognised in employee benefits expense.

No expense is recognised for awards that do not ultimately vest because service conditions have not been met. When the terms of an equity-settled award are modified, the minimum expense recognised is the grant date fair value of the unmodified award, provided the original vesting terms of the award are met. An additional expense, measured as at the date of modification, is recognised for any modification that increases the total fair value of the share-based payment transaction, or is otherwise beneficial to the employee. Where an award is cancelled by the entity or by the counterparty, any remaining element of the fair value of the award is expensed immediately through profit or loss.

The dilutive effect of outstanding options is reflected as additional share dilution in the computation of diluted earnings per share.

**2.13 Provisions, Contingent Liabilities and Contingent Assets**

Provisions are recognised when the Group has a present obligation (legal or constructive) as a result of a past event, it is probable that an outflow of resources embodying economic benefits will be required to settle the obligation and a reliable estimate can be made of the amount of the obligation. The expense relating to a provision is presented in the restated consolidated statement of profit and loss. Contingent liabilities are not recognised but disclosed unless the probability of an outflow of resources is remote. Contingent assets are disclosed where inflow of economic benefits is probable. If the effect of the time value of money is material, provisions are discounted using a current pre-tax rate that reflects, when appropriate, the risks specific to the liability. When discounting is used, the increase in the provision due to the passage of time is recognised as a finance costs.

**2.14 Cash and cash equivalents**

Cash and cash equivalents in the restated consolidated statement of assets and liabilities comprise cash at banks and on hand and short-term deposits with an original maturity of three months or less, which are subject to an insignificant risk of changes in value.

For the purpose of the restated consolidated statement of cash flows, cash and cash equivalents consist of cash and short-term deposits, as defined above, net of outstanding bank overdrafts as they are considered an integral part of the Group's cash management.

**2.15 Earnings per share**

Basic earnings per share is calculated by dividing the net profit or loss for the year/period attributable to equity shareholders of the Group by the weighted average number of equity shares outstanding during the year/period.

For the purpose of calculating diluted earnings per share, the net profit or loss for the year/period attributable to equity shareholders of the Group and the weighted average number of shares outstanding during the year/period are adjusted for the effects of all dilutive potential equity shares.

**2.16 Inventories**

Inventories are valued at lower of cost and net realizable value. Cost is determined as follows:

- i) In case of cars, at specific cost on identification basis of their individual costs.
- ii) In case of spares and others, the same are valued at weighted average basis.

Costs includes all non refundable duties and taxes and all other charges incurred in bringing the inventory to their present location and condition. Net realizable value is the estimated selling price less estimated cost necessary to make the sale.

**2.17 Segment Reporting**

An operating segment is component of the Group that engages in the business activity from which the Group earns revenues and incurs expenses, for which discrete financial information is available and whose operating results are regularly reviewed by the chief operating decision maker (CODM), in deciding about resources to be allocated to the segment and assess its performance. The Group's chief operating decision maker is the Chairman of Parent Company.

Segment revenue, segment expenses, segment assets and segment liabilities have been identified to segments on the basis of their relationship to the operating activities of the segment. Inter segment revenue is accounted on the basis of transactions which are primarily determined based on market / fair value factors. Revenue, expenses, assets and liabilities which relate to the Group as a whole and are not allocable to segments on a reasonable basis have been included under "unallocated revenue / expenses / assets / liabilities".

**2.18 Current versus non-current classification**

The Group presents assets and liabilities in the restated consolidated statement of assets and liabilities based on current / non-current classification.

An asset is treated as current when it is:

- Expected to be realized or intended to be sold or consumed in normal operating cycle;
- Held primarily for the purpose of trading;
- Expected to be realized within twelve months after the reporting period, or
- Cash or cash equivalent unless restricted from being exchanged or used to settle a liability for at least twelve months after the reporting period.

All other assets are classified as non-current.

A liability is current when:

- It is expected to be settled in normal operating cycle; or
- It is held primarily for the purpose of trading; or
- It is due to be settled within twelve months after the reporting period; or
- There is no unconditional right to defer the settlement of the liability for at least twelve months after the reporting period.

All other liabilities are classified as non-current.

Deferred tax assets and liabilities are classified as non-current assets and liabilities respectively.

The operating cycle is the time between the acquisition of assets for processing and their realisation in cash or cash equivalents. The Group has identified twelve months as its operating cycle.

**Landmark Cars Limited (formerly known as Landmark Cars Private Limited)**  
**Significant Accounting Policies to the Restated Consolidated Financial Information**  
(All amount in INR Millions unless otherwise stated)

**2.19 Foreign currency transactions**

**Initial recognition**

Transactions in foreign currencies entered into by the Group are accounted at the exchange rates prevailing on the date of the transaction or at rates that closely approximate the rate at the date of the transaction.

**Measurement at the balance sheet date**

Foreign currency monetary items of the Group, outstanding at the balance sheet date are restated at the period-end rates. Non-monetary items of the Group are carried at historical cost.

**Treatment of exchange differences**

Exchange differences arising on settlement / restatement of foreign currency monetary assets and liabilities of the Group are recognised as income or expense in the Consolidated Statement of Profit and Loss.

**2.20 Business Combinations and Goodwill**

In respect of business combination after transition date, the Group accounts for all business combinations by applying the acquisition method. All acquisition-related costs are expensed unless disclosed otherwise and are in accordance with applicable Accounting standards. On acquisition, the assets (including intangible assets), liabilities and contingent liabilities of an acquired entity are measured at their fair value. Non-controlling interest is stated at the non-controlling interest's proportion of the fair values of the assets and liabilities recognised.

Goodwill arising on consolidation represents the excess of the consideration transferred over the net fair value of the Group's share of the net assets, liabilities of the acquired subsidiary, joint venture or associate and the fair value of the non-controlling interest in the acquiree. If the consideration is less than the fair value of the Group's share of the net assets, liabilities of the acquired entity (i.e. Gain on acquisition), the difference is credited to the capital reserve in the period of acquisition.

**2.20 Cash Flow Statement**

Cash flows are reported using the indirect method, whereby loss for the period is adjusted for the effects of transactions of a non-cash nature, any deferrals or accruals of past or future operating cash receipts or payments and item of income or expenses associated with investing or financing cash flows. The cash flows from operating, investing and financing activities of the group are segregated.

**3.1 Recent accounting pronouncements issued but not yet effective**

Ministry of Corporate Affairs ("MCA") notifies new standard or amendments to the existing standards. There is no such notification which would have been applicable from October 1, 2021.

**3.2 Standards that became effective during the year**

There are no new Standards that became effective during the year. Amendments that became effective during the year did not have any material effect on restated consolidated financial information.

(All amount in INR Millions unless otherwise stated)  
Summary of Restatement Adjustments

4 Statement of restatement adjustments to consolidated audited financial statements

(a) Reconciliation between audited equity and restated equity

Particulars	Reference	As at				
		September 30, 2021	March 31, 2021	March 31, 2020	March 31, 2019	April 1, 2018
<b>Equity as per Special Purpose Consolidated Interim Financial Statements, Statutory Consolidated Ind AS Financial Statements and Statutory Indian GAAP Financial Statements, as applicable</b>		<b>2,093.17</b>	<b>1,823.76</b>	<b>1,699.09</b>	<b>2,147.20</b>	<b>902.67</b>
Impact of provision for Expected credit loss on Trade Receivables	(ii)	-	-	-	(19.50)	(3.55)
Impact on account of Business Combination	(iv)	-	-	-	(96.93)	
Deferred tax impact of above adjustments	(v)	-	-	-	3.64	0.79
<b>Equity as per Special Purpose Consolidated Interim Financial Statements, Statutory Consolidated Ind AS Financial Statements and Special Purpose Consolidated Ind AS Financial Statements, as applicable</b>		<b>2,093.17</b>	<b>1,823.76</b>	<b>1,699.09</b>	<b>2,034.41</b>	<b>899.91</b>
Impact of Lease Accounting	(i)	-	-	-	(171.55)	(82.96)
Deferred tax impact of above adjustments	(v)	-	-	-	26.70	11.72
<b>Total Equity as Restated Consolidated Financial Information</b>		<b>2,093.17</b>	<b>1,823.76</b>	<b>1,699.09</b>	<b>1,889.56</b>	<b>828.67</b>

(b) Reconciliation between audited profit/(loss) and restated profit/(loss)

Particulars	Reference	For the six months period ended	For the year ended		
		September 30, 2021	March 31, 2021	March 31, 2020	March 31, 2019
<b>Total Comprehensive Income / (Loss) or Profit / (Loss) after tax as per Special Purpose Consolidated Interim Financial Statements, Statutory Consolidated Ind AS Financial Statements and Statutory Indian GAAP Financial Statements, as applicable</b>		<b>282.64</b>	<b>124.66</b>	<b>(289.39)</b>	<b>(139.59)</b>
Share based payment cost measured at fair value	(iii)	-	-	-	(53.27)
Impact on account of Business Combination	(iv)	-	-	-	(3.24)
Impact of provision for Expected credit loss on Trade Receivables	(ii)	-	-	-	(15.95)
Deferred tax impact of above adjustments	(v)	-	-	-	2.86
<b>Total Comprehensive Income / (Loss) or Profit / (Loss) after tax as per Special Purpose Consolidated Interim Financial Statements, Statutory Consolidated Ind AS Financial Statements and Special Purpose Consolidated Ind AS Financial Statements, as applicable</b>		<b>282.64</b>	<b>124.66</b>	<b>(289.39)</b>	<b>(209.19)</b>
Impact on Accounting of Leases	(i)	-	-	-	(35.50)
Deferred tax impact of above adjustments	(v)	-	-	-	0.41
<b>Restated Total Comprehensive Income / (loss)</b>		<b>282.64</b>	<b>124.66</b>	<b>(289.39)</b>	<b>(244.28)</b>

(c) Reconciliation of total other equity as per audited financial statements with total other equity as per Restated Consolidated Financial Information

As specified in the Guidance Note, the total other equity balance computed under Restated Consolidated Financial Information for the year ended March 31, 2019 and total other equity balance computed on transition date on April 1, 2019, differs due to preparation of Special Purpose Ind AS financial statement as at and for the year ended March 31, 2019 (considering transition date as April 1, 2018) and other restatement adjustments made for the year ended March 31, 2019 and as at April 1, 2018. Accordingly, the closing total other equity balance as at March 31, 2019 of the Restated Consolidated Financial Information has not been carried forward to opening Balance sheet as at April 1, 2019.

The reconciliation of the same is as follows :

Particulars	Amount
<b>Total Other Equity :</b>	
Restated Total Other Equity as at March 31, 2019	1,696.51
(a) Adjustments not carried forward on account of Ind AS 116 restatement in the financial year ended March 31, 2019 :	
Impact on Retained Earnings on date of transition	1.25
Amortisation on Right-of-use assets	4.19
Interest on Lease Liability	0.64
Interest on Security Deposit	(0.17)
Indian GAAP Rent Reversal	(4.97)
Deferred tax impact of above adjustments	(0.17)
	0.77
(b) Adjustments not carried forward on account of preparation of special purpose Ind AS financial statement for the year ended March 31, 2019:	
(i) Adjustment to the Retained Earnings due to Scheme of Arrangement (Refer note 49):	
Effects on Capital Reserve on Business Combination (Refer Note 18)	(74.43)
Effects on Goodwill (Refer Note 7)	96.93
Effects on Capital Reserve on Consolidation (Refer Note 18)	(19.26)
	3.24
(ii) Adjustment to the Capital Reserve on Business Combination due to Scheme of Arrangement (Refer note 49):	74.43
(iii) Adjustment to the Capital Reserve on Consolidation due to Scheme of Arrangement (Refer note 49):	19.26
<b>Total Other Equity as at April 1, 2019 as per Statutory Consolidated Ind AS Financial Statements for year ended March 31, 2020</b>	<b>1,794.21</b>

- (d) **Material Regrouping**  
Appropriate regroupings have been made in the Restated Consolidated Statement of Assets and Liabilities, Restated Consolidated Statement of Profit and Loss and Restated Consolidated Statement of Cash flows, wherever required, by reclassification of the corresponding items of income, expenses, assets, liabilities and cash flows, in order to bring them in line with the accounting policies and classification as per IND AS financial information of the Group for the six months period ended September 30, 2021 prepared in accordance with Schedule III of Companies Act, 2013, requirements of IND AS 1 and other applicable IND AS principles and the requirements of the Securities and Exchange Board of India (Issue of Capital and Disclosure Requirements) Regulations 2018, as amended.
- (e) **Explanation for reconciliation of balance sheet as previously reported under Statutory Indian GAAP Financial Statements to Restated Consolidated Financial Information**
- (i) **Adjustments arising from lease accounting:**  
Under Statutory Indian GAAP Financial Statements, the Group recognised lease expenses as and when it is incurred in its statement of profit and loss. Upon transition, the Group has measured the right of use asset as at the date of transition to Ind AS at an amount equal to the lease liability, adjusted by the amount of any prepaid or accrued lease payments relating to such leases recognised in the balance sheet immediately before the date of transition to Ind AS.
- (ii) **Provision for Expected credit loss on Trade Receivables:**  
Under Statutory Indian GAAP Financial Statements, the Group has created provision for impairment of Trade receivables in respect of specific amount for incurred losses. Under Ind AS, the Company has recognised impairment loss on trade receivables based on the expected credit loss model.
- (iii) **Share based payment cost measured at fair value:**  
Under Statutory Indian GAAP Financial Statements, cost of equity settled employee share-based payments were recognised using the intrinsic value method. Upon transition, the cost is recognised based on the fair value of the options as on the grant date.
- (iv) **Impact on account of Business Combination**  
Under Statutory Indian GAAP Financial Statements, accounting for the Scheme of Arrangement was carried out in 2018-19 based on the effective date of the respective scheme and accordingly Goodwill / Capital Reserve were recognised. However on preparation of Special Purpose Ind AS financial statement for the year ended March 31, 2019, accounting for Scheme of Arrangement has been restated in accordance with Appendix C of Ind AS 103 - Business Combination, as if the business combination had occurred from the beginning of the period in the financial statements, irrespective of the actual effective date of the combination.
- (v) **Adjustments arising from deferred tax recognition**  
Deferred tax adjustments has been made in accordance with Ind AS, under balance sheet approach for all the items which have differential book base from that of taxbase and which temporarily gets reversed due to timing difference including adjustments arising from Ind AS transition.



Landmark Cars Limited (formerly known as Landmark Cars Private Limited)  
Notes to the Restated Consolidated Financial Information  
(All amount in INR Millions unless otherwise stated)

5 Property, Plant and Equipment

No.	Particulars	Lease Hold Improvements	Electrical Installations	Plant and Equipment	Computers	Furniture and Fixtures	Office Equipment	Vehicles	Buildings	Total
<b>a</b>	<b>Gross carrying amount (deemed cost)</b>									
	Balance as at April 1, 2018	660.28	51.75	214.01	22.16	167.66	67.99	184.99	-	1,368.84
	Additions	132.30	25.51	71.74	15.05	70.40	41.22	51.92	262.51	670.65
	Acquisitions through Scheme of Arrangement (Refer Note 49)	201.32	30.03	111.89	8.40	68.64	23.43	14.96	54.64	513.31
	Deductions	1.31	-	7.88	0.72	3.84	0.95	43.05	-	57.75
	<b>Balance as at March 31, 2019</b>	<b>992.59</b>	<b>107.29</b>	<b>389.76</b>	<b>44.89</b>	<b>302.86</b>	<b>131.69</b>	<b>208.82</b>	<b>317.15</b>	<b>2,495.05</b>
	Balance as at April 1, 2019	915.49	95.07	358.91	29.13	264.21	103.07	190.84	314.03	2,270.75
	Additions	46.20	8.49	11.56	6.21	16.77	9.48	91.80	1.74	192.25
	Deductions	13.27	3.04	5.17	1.22	4.69	2.55	55.34	6.17	91.45
	<b>Balance as at March 31, 2020</b>	<b>948.42</b>	<b>100.52</b>	<b>365.30</b>	<b>34.12</b>	<b>276.52</b>	<b>110.00</b>	<b>227.30</b>	<b>309.60</b>	<b>2,371.55</b>
	Additions	43.59	4.52	22.07	3.48	10.31	6.68	19.99	-	110.64
	Deductions	38.87	8.06	10.81	1.63	8.25	3.64	15.60	-	86.86
	<b>Balance as at March 31, 2021</b>	<b>953.14</b>	<b>96.98</b>	<b>376.56</b>	<b>35.97</b>	<b>278.35</b>	<b>113.04</b>	<b>231.69</b>	<b>309.60</b>	<b>2,395.33</b>
	Additions	41.87	16.28	15.78	3.60	31.40	6.46	80.15	-	195.54
	Additions due to business combination (Refer note 50)	-	-	11.37	-	0.17	-	-	-	11.54
	Deductions	1.71	1.08	0.18	0.13	5.60	0.93	18.21	1.13	28.97
	<b>Balance as at September 30, 2021</b>	<b>993.30</b>	<b>112.18</b>	<b>403.53</b>	<b>39.44</b>	<b>304.32</b>	<b>118.57</b>	<b>293.63</b>	<b>308.47</b>	<b>2,573.44</b>
<b>b</b>	<b>Accumulated Depreciation</b>									
	Balance as at April 1, 2018	-	-	-	-	-	-	-	-	-
	For the year	77.10	12.22	31.99	15.87	39.82	28.70	30.06	3.12	238.88
	Deductions	-	-	1.14	0.11	1.17	0.08	12.08	-	14.58
	<b>Balance as at March 31, 2019</b>	<b>77.10</b>	<b>12.22</b>	<b>30.85</b>	<b>15.76</b>	<b>38.65</b>	<b>28.62</b>	<b>17.98</b>	<b>3.12</b>	<b>224.30</b>
	Balance as at April 1, 2019	-	-	-	-	-	-	-	-	-
	For the year	93.44	16.25	33.01	13.55	40.10	31.49	30.05	9.46	267.35
	Deductions	2.85	0.56	0.75	0.39	0.86	0.70	3.89	0.25	10.25
	<b>Balance as at March 31, 2020</b>	<b>90.59</b>	<b>15.69</b>	<b>32.26</b>	<b>13.16</b>	<b>39.24</b>	<b>30.79</b>	<b>26.16</b>	<b>9.21</b>	<b>257.10</b>
	For the year	103.55	12.58	33.18	10.34	36.85	27.24	31.41	9.35	264.50
	Deductions	13.61	4.25	1.26	1.31	1.49	1.63	3.75	-	27.30
	<b>Balance as at March 31, 2021</b>	<b>180.53</b>	<b>24.02</b>	<b>64.18</b>	<b>22.19</b>	<b>74.60</b>	<b>56.40</b>	<b>53.82</b>	<b>18.56</b>	<b>494.30</b>
	For the period	44.57	6.31	16.72	2.97	19.10	10.97	16.79	4.68	122.11
	Deductions	1.22	0.60	0.01	0.11	2.47	0.77	6.41	0.90	12.49
	<b>Balance as at September 30, 2021</b>	<b>223.88</b>	<b>29.73</b>	<b>80.89</b>	<b>25.05</b>	<b>91.23</b>	<b>66.60</b>	<b>64.20</b>	<b>22.34</b>	<b>603.92</b>
<b>c</b>	<b>Net carrying amount</b>									
	Balance as at March 31, 2019	915.49	95.07	358.91	29.13	264.21	103.07	190.84	314.03	2,270.75
	Balance as at March 31, 2020	857.83	84.83	333.04	20.96	237.05	79.21	201.14	300.39	2,114.45
	Balance as at March 31, 2021	772.61	72.96	312.38	13.78	203.75	56.64	177.87	291.04	1,901.03
	Balance as at September 30, 2021	769.42	82.45	322.64	14.39	213.09	51.97	229.43	286.13	1,969.52

**Landmark Cars Limited (formerly known as Landmark Cars Private Limited)**  
**Notes to the Restated Consolidated Financial Information**  
**(All amount in INR Millions unless otherwise stated)**

**Notes:**

**5.1** For properties pledged as securities, refer note 19

**5.2** The title deeds of all immovable properties are held in the name of the Group.

**5.3 Capital-Work-in Progress (CWIP)**

Particulars	As at			
	September 30, 2021	March 31, 2021	March 31, 2020	March 31, 2019
Capital Work-in-Progress	24.36	6.76	0.33	-
	<b>24.36</b>	<b>6.76</b>	<b>0.33</b>	-

**Capital-Work-in Progress (CWIP) Ageing Schedule**

Projects in Progress	Amount in CWIP for a period of				Total
	Less than 1 year	1-2 years	2-3 years	More than 3 years	
As at September 30, 2021	24.36	-	-	-	<b>24.36</b>
As at March 31, 2021	6.76	-	-	-	<b>6.76</b>
As at March 31, 2020	0.33	-	-	-	<b>0.33</b>
As at March 31, 2019	-	-	-	-	-

**5.4** There are no overdue or cost overrun projects compared to its original plan and no periods which are temporarily suspended, on the above mentioned reporting dates.

**5.5** For loss due to fire, refer note (Refer Note 48)

**5.6** Refer Note 43 for deemed cost of property plant and equipment

Landmark Cars Limited (formerly known as Landmark Cars Private Limited)  
Notes to the Restated Consolidated Financial Information  
(All amount in INR Millions unless otherwise stated)

6 Right-of-use assets

No.	Particulars	Plant and equipment	Building	Total
<b>a</b>	<b>Gross carrying amount</b>			
	On adoption of Ind AS 116 as at April 1, 2018	20.36	1,061.85	1,082.21
	Additions	30.96	626.12	657.08
	Deductions	-	-	-
	<b>Balance as at March 31, 2019</b>	<b>51.32</b>	<b>1,687.97</b>	<b>1,739.29</b>
	Restatement Adjustments	(7.70)	(284.18)	(291.88)
	<b>Balance as at April 1, 2019</b>	<b>43.62</b>	<b>1,403.79</b>	<b>1,447.41</b>
	Additions	8.86	204.18	213.04
	Deductions	-	-	-
	<b>Balance as at March 31, 2020</b>	<b>52.48</b>	<b>1,607.97</b>	<b>1,660.45</b>
	Additions	-	131.88	131.88
	Deductions	-	-	-
	<b>Balance as at March 31, 2021</b>	<b>52.48</b>	<b>1,739.85</b>	<b>1,792.33</b>
	Additions	-	182.41	182.41
	Deductions	-	37.72	37.72
	<b>Balance as at September 30, 2021</b>	<b>52.48</b>	<b>1,884.54</b>	<b>1,937.02</b>
<b>b</b>	<b>Accumulated amortization</b>			
	<b>On adoption of Ind AS 116 as at April 1, 2018</b>	-	-	-
	For the year	7.70	278.97	286.67
	Deductions	-	-	-
	<b>Balance as at March 31, 2019</b>	<b>7.70</b>	<b>278.97</b>	<b>286.67</b>
	Restatement Adjustments	(7.70)	(278.97)	(286.67)
	<b>Balance as at April 1, 2019</b>	-	-	-
	For the year	11.66	337.80	349.46
	Deductions	-	-	-
	<b>Balance as at March 31, 2020</b>	<b>11.66</b>	<b>337.80</b>	<b>349.46</b>
	For the year	12.53	334.83	347.36
	Deductions	-	-	-
	<b>Balance as at March 31, 2021</b>	<b>24.19</b>	<b>672.63</b>	<b>696.82</b>
	For the period	5.29	176.87	182.16
	Deductions	-	-	-
	<b>Balance as at September 30, 2021</b>	<b>29.48</b>	<b>849.50</b>	<b>878.98</b>
<b>c</b>	<b>Net carrying amount</b>			
	Balance as at March 31, 2019	43.62	1,409.00	<b>1,452.62</b>
	Balance as at April 1, 2019	43.62	1,403.79	<b>1,447.41</b>
	Balance as at March 31, 2020	40.82	1,270.17	<b>1,310.99</b>
	Balance as at March 31, 2021	28.29	1,067.22	<b>1,095.51</b>
	Balance as at September 30, 2021	23.00	1,035.04	<b>1,058.04</b>

7 Goodwill

No.	Particulars	Goodwill acquired separately	Goodwill on consolidation	Total
	<b>Gross carrying amount</b>			
	Balance as at April 1, 2018	60.00	64.74	124.74
	Additions	10.00	-	10.00
	Impairment	-	-	-
	<b>Balance as at March 31, 2019</b>	<b>70.00</b>	<b>64.74</b>	<b>134.74</b>
	Add: Restatement Adjustments (Refer Note 4)	-	96.93	96.93
	<b>Balance as at April 1, 2019</b>	<b>70.00</b>	<b>161.67</b>	<b>231.67</b>
	Additions	-	-	-
	Impairment	-	-	-
	<b>Balance as at March 31, 2020</b>	<b>70.00</b>	<b>161.67</b>	<b>231.67</b>
	Additions	-	-	-
	Impairment	-	-	-
	<b>Balance as at March 31, 2021</b>	<b>70.00</b>	<b>161.67</b>	<b>231.67</b>
	Additions due to business combination (Refer note 50)	2.34	-	2.34
	Impairment	-	-	-
	<b>Balance as at September 30, 2021</b>	<b>72.34</b>	<b>161.67</b>	<b>234.01</b>

**Note:**

The goodwill is tested for impairment annually and as at September 30, 2021, the goodwill is not impaired.

The recoverable amounts of the CGUs are determined from value-in-use calculations. The key assumptions for the value-in-use calculations are those regarding the discount rates, growth rates and expected changes to direct costs during the year. Management estimates discount rates using pre-tax rates that reflect current market assessments of the time value of money.

The growth rates are based on management's forecasts. Changes in selling prices and direct costs are based on past practices and expectations of future changes in the market. The Group prepares its forecasts based on the most recent financial budgets approved by management with projected revenue growth rates at 10% p.a. The rates used to discount the forecasts is 11.75% p.a.

Management believes that any reasonable possible change in any of these assumptions would not cause the carrying amount to exceed its recoverable amount.

8 Other intangible assets

No.	Particulars	Computer Software	Customer relationship	Non-compete Fees	Total
<b>a</b>	<b>Gross carrying amount (deemed cost)</b>				
	Balance as at April 1, 2018	0.07	-	-	0.07
	Acquisitions through Scheme of Arrangement (Refer Note 49)	0.38	-	-	0.38
	Additions	39.65	-	25.50	65.15
	Deductions	-	-	-	-
	<b>Balance as at March 31, 2019</b>	<b>40.10</b>	<b>-</b>	<b>25.50</b>	<b>65.60</b>
	<b>Balance as at April 1, 2019</b>	<b>35.98</b>	<b>-</b>	<b>21.01</b>	<b>56.99</b>
	Additions	0.44	-	-	0.44
	Deductions	0.35	-	-	0.35
	<b>Balance as at March 31, 2020</b>	<b>36.07</b>	<b>-</b>	<b>21.01</b>	<b>57.08</b>
	Additions	0.05	-	-	0.05
	Deductions	-	-	-	-
	<b>Balance as at March 31, 2021</b>	<b>36.12</b>	<b>-</b>	<b>21.01</b>	<b>57.13</b>
	Additions due to business combination (Refer note 50)	-	15.00	-	15.00
	Deductions	-	-	-	-
	<b>Balance as at September 30, 2021</b>	<b>36.12</b>	<b>15.00</b>	<b>21.01</b>	<b>72.13</b>
<b>b</b>	<b>Accumulated amortization</b>				
	Balance as at April 1, 2018	-	-	-	-
	For the year	4.12	-	4.49	8.61
	Deductions	-	-	-	-
	<b>Balance as at March 31, 2019</b>	<b>4.12</b>	<b>-</b>	<b>4.49</b>	<b>8.61</b>
	<b>Balance as at April 1, 2019</b>	<b>-</b>	<b>-</b>	<b>-</b>	<b>-</b>
	For the year	7.86	-	4.85	12.71
	Deductions	0.23	-	-	0.23
	<b>Balance as at March 31, 2020</b>	<b>7.63</b>	<b>-</b>	<b>4.85</b>	<b>12.48</b>
	For the year	7.65	-	5.26	12.91
	Deductions	-	-	-	-
	<b>Balance as at March 31, 2021</b>	<b>15.28</b>	<b>-</b>	<b>10.11</b>	<b>25.39</b>
	For the period	3.90	0.48	2.33	6.71
	Deductions	-	-	-	-
	<b>Balance as at September 30, 2021</b>	<b>19.18</b>	<b>0.48</b>	<b>12.44</b>	<b>32.10</b>
<b>c</b>	<b>Net carrying amount</b>				
	Balance as at March 31, 2019	35.98	-	21.01	56.99
	Balance as at March 31, 2020	28.44	-	16.16	44.60
	Balance as at March 31, 2021	20.84	-	10.90	31.74
	Balance as at September 30, 2021	16.94	14.52	8.57	40.03

**8.1 Intangible Assets under development**

Particulars	As at			
	September 30, 2021	March 31, 2021	March 31, 2020	March 31, 2019
Intangible assets under development	9.07	8.96	6.41	4.38
	<b>9.07</b>	<b>8.96</b>	<b>6.41</b>	<b>4.38</b>

**Intangible assets under development ageing schedule**

Projects in progress	Amount in Intangible assets under development for a period of				Total
	Less than 1 year	1-2 years	2-3 years	More than 3 years	
As at September 30, 2021	1.49	1.58	1.96	4.04	<b>9.07</b>
As at March 31, 2021	2.55	2.03	0.70	3.68	<b>8.96</b>
As at March 31, 2020	2.03	0.70	3.68	-	<b>6.41</b>
As at March 31, 2019	0.70	3.68	-	-	<b>4.38</b>

**8.2** There are no overdue or cost overrun projects compared to its original plan and no periods which are temporarily suspended, on the above mentioned reporting dates.

**8.3** Refer Note 43 for deemed cost of intangible assets

9 Investments

Particulars	As at			
	September 30, 2021	March 31, 2021	March 31, 2020	March 31, 2019
<b>Non-current investments</b>				
<b>(i) Equity shares - Unquoted (Investments at fair value through OCI)</b>				
3,326 (as at March 31, 2021 - 3,326, as at March 31, 2020 - 10 and as at March 31, 2019 - Nil) equity shares of Re 1 each in Chatpay Commerce Private Limited	8.19	8.19	*	-
<b>(ii) Preference shares - Unquoted (Investments at fair value through OCI)</b>				
31,531 (as at March 31, 2021 - 31,531, as at March 31, 2020 - 31,531 and as at March 31, 2019: Nil) Compulsory Convertible Cumulative Preference shares of Re 1 each in Chatpay Commerce Private Limited	77.91	77.91	71.34	-
6,371 (as at March 31, 2021 - 6,371, as at March 31, 2020 - 6,371 and as at March 31, 2019: Nil) Preference shares of Re 1 each in Chatpay Commerce Private Limited	15.74	15.74	8.65	-
84,334 (as at March 31, 2021 - 42,167, as at March 31, 2020 - Nil and as at March 31, 2019: Nil) Compulsory Convertible Preference Shares of Rs. 10 each in Sheerdrive Private Limited	55.66	27.83	-	-
<b>Total Non - Current Investments (A)</b>	<b>157.50</b>	<b>129.67</b>	<b>79.99</b>	<b>-</b>
<b>Current Investments</b>				
<b>Mutual fund - Quoted (Valued at fair value through profit or loss)</b>				
SBI Overnight Fund	-	-	22.50	-
<b>Total Current Investments (B)</b>	<b>-</b>	<b>-</b>	<b>22.50</b>	<b>-</b>
<b>Total Investments (A + B)</b>	<b>157.50</b>	<b>129.67</b>	<b>102.49</b>	<b>-</b>
* 0.00 denotes figures are below the rounding off norms adopted by the Group				
Aggregate amount of unquoted investments	157.50	129.67	79.99	-
Aggregate amount of quoted investments	-	-	22.50	-
Aggregate amount of impairment in value of investments	-	-	-	-

Notes:

In the financial year 2019-20, the Group had invested in equity and preference shares of Chatpay Commerce Private Limited, which is in the business of providing online/digital platform for enabling car services and repair through their network of third party garages. Such investment is made with the approval of Board of Directors.

In the financial year 2020-21 and during the six months period ended September 30, 2021, the Group has invested in Preference shares of Sheerdrive Private Limited which is in the business of providing online/digital platform for enabling car exchange of vehicles at real time market derived price. Such investment is made with the approval of Board of Directors.

10 Loans

Particulars	As at			
	September 30, 2021	March 31, 2021	March 31, 2020	March 31, 2019
<b>Non-current</b>				
<b>(Unsecured, considered good)</b>				
Inter-corporate deposits	-	-	308.50	15.29
	-	-	<b>308.50</b>	<b>15.29</b>
<b>Current</b>				
<b>(Unsecured, considered good)</b>				
Inter-corporate deposits	394.45	561.67	142.43	56.48
Loans to employees	1.93	1.74	6.18	8.39
	<b>396.38</b>	<b>563.41</b>	<b>148.61</b>	<b>64.87</b>

Loans are repayable on demand carries interest rate in the range of 8% to 10% p.a.

11 Other Financial Assets

Particulars	As at			
	September 30, 2021	March 31, 2021	March 31, 2020	March 31, 2019
<b>Non-current</b>				
<b>(Unsecured, considered good)</b>				
Advance for purchase of non-current investments	-	-	7.50	-
Security deposits	166.66	125.52	140.53	168.45
	<b>166.66</b>	<b>125.52</b>	<b>148.03</b>	<b>168.45</b>
<b>Current</b>				
<b>(Unsecured, considered good)</b>				
Claims recoverable from suppliers				
Unsecured, considered good	212.15	257.81	252.27	388.49
Unsecured - credit impaired	1.00	1.00	0.09	2.45
Less : Allowance for claims from suppliers	(1.00)	(1.00)	(0.09)	(2.45)
	<b>212.15</b>	<b>257.81</b>	<b>252.27</b>	<b>388.49</b>
Insurance claims	-	-	-	19.08
Interest accrued on deposits	0.34	3.22	2.94	2.81
Share issue expenses*	13.79	-	-	-
Security deposits	3.52	6.64	7.09	1.78
Receivable on sale of property, plant and equipment	-	0.17	2.65	6.22
Others	8.84	8.18	24.13	14.87
	<b>238.64</b>	<b>276.02</b>	<b>289.08</b>	<b>433.25</b>

\*The Parent has incurred expenses towards proposed Initial Public Offering of its equity shares. The Parent expects to recover certain amounts from the shareholders and the balance amount would be charged-off to securities premium account in accordance with Section 52 of the Companies Act, 2013 upon the shares being issued.

Particulars	As at			
	September 30, 2021	March 31, 2021	March 31, 2020	March 31, 2019
<b>Non-current</b>				
Prepaid expenses	0.48	0.29	0.27	0.34
Capital advances	21.15	21.02	6.14	4.29
	<b>21.63</b>	<b>21.31</b>	<b>6.41</b>	<b>4.63</b>
<b>Current</b>				
Prepaid expenses	15.01	18.14	15.33	20.67
Balance with Government Authorities	617.36	679.65	566.42	722.57
Advance to suppliers	10.04	16.87	59.83	33.77
Advances to staff	1.70	1.10	1.39	0.77
	<b>644.11</b>	<b>715.76</b>	<b>642.97</b>	<b>777.78</b>

13 Inventories (at lower of cost and net realisable value)

Particulars	As at			
	September 30, 2021	March 31, 2021	March 31, 2020	March 31, 2019
Cars (Refer note (a) below)	2,879.93	2,402.07	1,811.95	2,952.04
Spares and lubricants (Refer note (b) below)	562.96	486.15	445.68	445.92
	<b>3,442.89</b>	<b>2,888.22</b>	<b>2,257.63</b>	<b>3,397.96</b>

Notes:

(a) Includes Goods-in-Transit Rs. 721.50 Millions (as at March 31, 2021 - Rs. 577.66 Millions, as at March 31, 2020 - Rs. 55.82 Millions and as at March 31, 2019 - Rs. 330.84 Millions)

(b) Includes Goods-in-Transit Rs. 31.84 Millions (as at March 31, 2021 - Rs. 24.78 Millions, as at March 31, 2020 - Rs. 12.79 Millions and as at March 31, 2019 - Rs. 15.37 Millions)

(c) Borrowings are secured by first pari passu charge on stock and book debts. (Refer Note 19)

(d) During the six months period ended September 30, 2021, Rs. 11.87 Millions (for the year ended March 31, 2021 - Rs. 17.33 Millions, for the year ended March 31, 2020: Rs. 5.86 Millions and for the year ended March 31, 2019 - Rs. 37.28 Millions) is recognised as an expense for inventories carried at net realisable value.

14 Trade Receivables

Particulars	As at			
	September 30, 2021	March 31, 2021	March 31, 2020	March 31, 2019
<b>Current</b>				
Unsecured, considered Good	710.38	567.03	249.02	802.97
Less : Allowance for doubtful debts	8.47	9.19	12.57	19.50
	<b>701.91</b>	<b>557.84</b>	<b>236.45</b>	<b>783.47</b>
Unsecured - considered doubtful	1.96	1.89	2.23	8.65
Less : Allowances for expected credit loss due to increase in credit risk ("ECL")	1.96	1.89	2.23	8.65
	<b>-</b>	<b>-</b>	<b>-</b>	<b>-</b>
	<b>701.91</b>	<b>557.84</b>	<b>236.45</b>	<b>783.47</b>

Notes :

(a) Trade receivables are non-interest bearing and are generally on terms of 0 days to 60 days.

(b) For amount receivables from related parties, refer note 44

(c) Borrowings are secured by first pari passu charge on stock and book debts. (Refer Note 19)

(d) No trade receivable are due from directors or other officers of the Group either severally or jointly with any other person; nor from firms or private companies in which any director is a partner, a director or a member.

(e) Movement in credit loss allowance

Particulars	As at September 30, 2021	As at March 31, 2021	As at March 31, 2020	As at March 31, 2019
Opening Balance	11.08	14.80	28.15	6.97
Changes in provision during the year/period	(0.65)	(3.72)	(13.35)	21.18
<b>Closing balance</b>	<b>10.43</b>	<b>11.08</b>	<b>14.80</b>	<b>28.15</b>

Ageing of Trade Receivables (Gross)

Particulars (Outstanding from due date of payment / from date of transaction)	As at			
	September 30, 2021	March 31, 2021	March 31, 2020	March 31, 2019
<b>(i) Undisputed Trade Receivables – considered good</b>				
Less than 6 months	611.38	516.87	215.90	724.12
6 months - 1 year	65.81	19.15	17.48	61.78
1-2 years	7.42	4.91	5.20	9.76
2-3 years	0.81	0.25	0.45	0.14
More than 3 years	5.18	0.20	0.96	0.16
	<b>690.60</b>	<b>541.38</b>	<b>239.99</b>	<b>795.96</b>
<b>(ii) Undisputed Trade Receivables – which have significant increase in credit risk</b>				
Less than 6 months	-	-	-	2.84
6 months - 1 year	-	-	-	0.73
1-2 years	0.03	-	-	0.52
2-3 years	0.56	-	-	0.88
More than 3 years	1.37	0.13	0.13	-
	<b>1.96</b>	<b>0.13</b>	<b>0.13</b>	<b>4.97</b>
<b>(iii) Disputed Trade Receivables – considered good</b>				
Less than 6 months	-	0.03	0.31	0.42
6 months - 1 year	-	0.35	0.05	1.52
1-2 years	0.30	0.75	2.45	1.98
2-3 years	0.01	2.35	4.57	0.54
More than 3 years	-	3.84	0.24	0.49
	<b>0.31</b>	<b>7.32</b>	<b>7.62</b>	<b>4.95</b>
<b>(iv) Disputed Trade Receivables – which have significant increase in credit risk</b>				
Less than 6 months	-	-	-	1.39
6 months - 1 year	-	-	0.06	0.10
1-2 years	-	0.69	0.98	1.48
2-3 years	-	-	0.48	0.32
More than 3 years	-	1.07	0.59	0.40
	<b>-</b>	<b>1.76</b>	<b>2.11</b>	<b>3.69</b>
<b>(v) Unbilled dues</b>				
Less than 6 months	19.47	18.34	1.39	2.07
6 months - 1 year	-	-	-	-
1-2 years	-	-	-	-
2-3 years	-	-	-	-
More than 3 years	-	-	-	-
	<b>19.47</b>	<b>18.34</b>	<b>1.39</b>	<b>2.07</b>
	<b>712.34</b>	<b>568.93</b>	<b>251.24</b>	<b>811.64</b>

15 Cash and cash equivalents

Particulars	As at			
	September 30, 2021	March 31, 2021	March 31, 2020	March 31, 2019
Balance with banks in current accounts	556.50	142.82	270.16	234.30
Cheques on hand	24.35	1.89	0.90	70.59
Cash on hand	6.10	5.63	5.95	17.55
	<b>586.95</b>	<b>150.34</b>	<b>277.01</b>	<b>322.44</b>

16 Other balances with banks

Particulars	As at			
	September 30, 2021	March 31, 2021	March 31, 2020	March 31, 2019
Balances held as margin money against guarantees	119.25	76.86	56.26	43.24
	<b>119.25</b>	<b>76.86</b>	<b>56.26</b>	<b>43.24</b>

17 Equity Share Capital

Particulars	As at			
	September 30, 2021	March 31, 2021	March 31, 2020	March 31, 2019
<b>Authorized</b>				
2,68,50,000 (as at March 31, 2021 - 2,68,50,000, as at March 31, 2020: 2,68,50,000 and as at March 31, 2019: 2,68,50,000) Equity Shares of Rs. 10/- each	268.50	268.50	268.50	268.50
2,00,000 (as at March 31, 2021 - 2,00,000, as at March 31, 2020: 2,00,000 and as at March 31, 2019: 2,00,000) Preference shares of Rs. 10/- each	2.00	2.00	2.00	2.00
	<b>270.50</b>	<b>270.50</b>	<b>270.50</b>	<b>270.50</b>
<b>Issued, subscribed and fully paid-Up</b>				
1,83,12,810 (as at March 31, 2021 - 1,83,12,810, as at March 31, 2020: 1,83,12,810 and as at March 31, 2019 : 1,83,12,810) Equity Shares of Rs. 10/- each fully paid up	183.13	183.13	183.13	183.13
	<b>183.13</b>	<b>183.13</b>	<b>183.13</b>	<b>183.13</b>

17.2 Rights, preferences and restrictions :

The Parent has issued only one class of equity shares having a face value of Rs. 10 per share. Each holder of equity shares is entitled to one vote per share. The dividend proposed by the Board of Directors is subject to the approval of the shareholders in the ensuing Annual General Meeting except in case of interim dividend. In the event of liquidation, the equity shareholders are eligible to receive the remaining assets of the parent Company after distribution of all preferential amounts, in proportion to their shareholding.

17.3 Shares allotted as fully paid up by way of other than cash during five years immediately preceding September 30, 2021:

- (a) The Parent had allotted 1,27,682 and 65,93,825 equity shares as fully paid up bonus shares by utilisation of securities premium account during the year 2015-16 and 2016-17 respectively.
- (b) Pursuant to the Scheme of Arrangement, the Parent had allotted 1,04,00,220 equity shares as fully paid up during the year 2018-19 (Refer Note 49).

17.4 Reconciliation of number of shares and amount outstanding at the beginning and at the end of the reporting period :

Particulars	No. of Shares	Rs in Millions
<b>Balance as at April 1, 2018</b>	<b>79,12,590</b>	<b>79.13</b>
Issued during the year (Refer Note 17.3)	1,04,00,220	104.00
<b>Balance as at March 31, 2019</b>	<b>1,83,12,810</b>	<b>183.13</b>
<b>Balance as at April 1, 2019</b>	<b>1,83,12,810</b>	<b>183.13</b>
Issued during the year	-	-
<b>Balance as at March 31, 2020</b>	<b>1,83,12,810</b>	<b>183.13</b>
Issued during the year	-	-
<b>Balance as at March 31, 2021</b>	<b>1,83,12,810</b>	<b>183.13</b>
Issued during the period	-	-
<b>Balance as at September 30, 2021</b>	<b>1,83,12,810</b>	<b>183.13</b>

Subsequent to September 30, 2021, pursuant to a resolution passed in the extra-ordinary general meeting dated November 10, 2021, Shareholders have approved split of each equity share of face value of Rs. 10 each into two equity shares of face value of Rs 5 each (the "Split"). (Refer Note 47)

17.5 Details of shareholders holding more than 5 per cent shares :

Name of the Shareholders	As at September 30, 2021	As at March 31, 2021	As at March 31, 2020	As at March 31, 2019
	No. of Shares %	No. of Shares %	No. of Shares %	No. of Shares %
Sanjay Karsandas Thakker	75,77,384 41.38%	75,77,384 41.38%	75,77,384 41.38%	75,77,384 41.38%
Ami Sanjay Thakker	27,92,424 15.25%	27,92,424 15.25%	27,92,424 15.25%	27,47,424 15.00%
TPG Growth II SF Pte. Ltd	54,39,597 29.70%	54,39,597 29.70%	54,39,597 29.70%	54,39,597 29.70%



17.6 Details of shareholding of promoters\*

Name of the Promoters	As at September 30, 2021	As at March 31, 2021	As at March 31, 2020	As at March 31, 2019
	No. of Shares %	No. of Shares %	No. of Shares %	No. of Shares %
Sanjay Karsandas Thakker	75,77,384 41.38%	75,77,384 41.38%	75,77,384 41.38%	75,77,384 41.38%
	% change during the year	No change	No change	No change

\*For the purpose of disclosure, definition of promoter as per the Companies Act, 2013 has been considered.

18 Other equity

Particulars	As at			
	September 30, 2021	March 31, 2021	March 31, 2020	March 31, 2019
<b>Capital Reserve on Business Combination</b>				
Opening Balance	1,275.92	1,275.92	1,275.92	-
Add: Effect of Scheme of Arrangement (Refer Note 49)	-	-	-	1,201.49
Closing Balance	<b>1,275.92</b>	<b>1,275.92</b>	<b>1,275.92</b>	<b>1,201.49</b>
Add: Restatement Adjustments (Refer Note 4)	-	-	-	74.43
<b>Opening balance after restatement adjustments as at April 1, 2019</b>				<b>1,275.92</b>
<b>Securities Premium</b>				
Opening Balance	425.27	425.27	425.27	425.27
Closing Balance	<b>425.27</b>	<b>425.27</b>	<b>425.27</b>	<b>425.27</b>
<b>Share options outstanding account</b>				
Opening Balance	55.52	55.51	54.29	-
Add: Additions during the period/year (Refer Note 45)	0.51	0.01	1.22	54.29
Closing Balance	<b>56.03</b>	<b>55.52</b>	<b>55.51</b>	<b>54.29</b>
<b>Capital Redemption Reserve</b>				
Opening Balance	0.02	0.02	0.02	0.02
Closing Balance	<b>0.02</b>	<b>0.02</b>	<b>0.02</b>	<b>0.02</b>
<b>Capital Reserve on consolidation</b>				
Opening Balance	19.26	19.26	19.26	-
Add: Additions during the period/year	-	-	-	-
Closing Balance	<b>19.26</b>	<b>19.26</b>	<b>19.26</b>	-
Add: Restatement Adjustments (Refer Note 4)	-	-	-	19.26
<b>Opening balance after restatement adjustments as at April 1, 2019</b>				<b>19.26</b>
<b>Retained Earnings</b>				
Opening Balance	(154.55)	(267.86)	19.45	322.60
Add / (less) : Impact of Ind AS 116 on account of Scheme of Arrangement (Refer Note 49)	-	-	-	(38.52)
Add: Restated Profit/(Loss) for the period/year	277.80	113.31	(287.31)	(252.55)
Less: Final Dividend*	(13.74)	-	-	(13.37)
Less: Tax on dividend*	-	-	-	(2.72)
Closing Balance	<b>109.51</b>	<b>(154.55)</b>	<b>(267.86)</b>	<b>15.44</b>
Add: Restatement Adjustments (Refer Note 4)	-	-	-	4.01
<b>Opening balance after restatement adjustments as at April 1, 2019</b>				<b>19.45</b>
<b>Other Comprehensive Income</b>				
Opening Balance	13.18	-	-	-
Add: Fair value gain on investments in shares through other comprehensive income	3.17	13.18	-	-
Closing Balance	<b>16.35</b>	<b>13.18</b>	-	-
	<b>1,902.36</b>	<b>1,634.62</b>	<b>1,508.12</b>	<b>1,696.51</b>

Notes:

\* During the six months period ended September 30, 2021, the Parent paid final dividend of Rs. 0.75 per equity share aggregating to Rs. 13.74 millions pertaining for the year ended March 31, 2021, which was approved in the annual general meeting held on July 30, 2021.

\* During the year ended March 31, 2019, the Parent paid final dividend of Rs. 1.69 per equity share aggregating to Rs. 16.09 millions (including tax on dividend) for the year ended March 31, 2018 which was approved in the annual general meeting held on September 28, 2018.

**Nature and purpose of reserves**

**Capital reserve on business combination**

Capital reserve represents the excess amount of net assets acquired over and above the liabilities pursuant to the Scheme of Arrangement and Amalgamation.

**Securities premium**

Securities premium represents the premium received on issue of shares over and above the face value of equity shares. The same is available for utilisation in accordance with the provisions of the Companies Act, 2013.

**Share options outstanding account**

The fair value of the equity-settled share based payment transactions with employees is recognised in Statement of Profit and Loss with corresponding credit to Stock Options Outstanding Account.

**Retained earnings**

Retained earnings represents the Group's undistributed earnings after taxes.

**Capital redemption reserve**

Capital redemption reserve has been created pursuant to the requirements of the Act under which the Group is required to transfer certain amounts on redemption of preference shares. The Group has redeemed the underlying preference shares in the earlier years. The capital redemption reserve can be utilised for issue of bonus shares.

**Other comprehensive income**

This represents the cumulative gains and losses arising on the revaluation of preference instruments measured at fair value through other comprehensive income, under an irrevocable option, net of amounts reclassified to retained earnings when such assets are disposed off.

19 Borrowings

Particulars	As at			
	September 30, 2021	March 31, 2021	March 31, 2020	March 31, 2019
<b>Non-Current</b>				
<b>Term loan - Secured - at amortised cost</b>				
From a Bank (refer note (a) below)	47.57	38.83	35.42	12.58
From others (refer note (b) and (c) below)	320.55	320.79	249.65	147.34
<b>Vehicle loan - Secured - at amortised cost</b>				
From a Bank (refer note (d) below)	44.67	54.08	66.95	-
From others (refer note (e) below)	-	-	-	122.12
	412.79	413.70	352.02	282.04
Less: Current maturities of non-current borrowings disclosed under "Current Borrowings"	130.51	77.45	70.15	85.63
	282.28	336.25	281.87	196.41
<b>Unsecured</b>				
Loan from related parties (Refer note 44) (Refer note (f) below)	134.60	151.40	-	168.61
Loan from others (Refer note (m) and (n) below)	50.00	-	243.81	91.19
	466.88	487.65	525.68	456.21
<b>Current</b>				
<b>Secured - at amortised cost</b>				
Working Capital Loan from banks (Refer note (h) below)	582.39	401.87	218.87	1,196.39
Working Capital Loan from others (Refer note (i) below)	1,071.61	518.53	497.17	629.93
Current maturities of non-current borrowings	130.51	77.45	70.15	85.63
<b>Unsecured - at amortised cost</b>				
Working Capital Loan from banks (Refer note (j) below)	115.64	24.31	257.17	40.82
Loan from others (Refer note (k) and (l) below)	411.26	536.60	154.59	98.81
Loan from related parties (Refer note 44) (Refer note (g) below)	57.88	44.50	76.54	-
	2,369.29	1,603.26	1,274.49	2,051.58

Notes

(a) Term Loan from Bank of Rs. 47.57 millions (as at March 31, 2021: Rs. 38.83 millions, as at March 31, 2020: Rs. 35.42 millions and as at March 31, 2019: Rs. 12.58 millions) carrying interest rate ranging from 8.10 % p.a. to 11.60 % p.a. are primarily secured by way of plant and machinery, equipment, furniture and fixtures and chattels of building at Ahmedabad owned by Landmark Automobiles Private Limited, residential building owned by Mr. Sanjay Thakker at Mumbai and further secured by personal guarantees of 2 Directors.

(b) Term Loan From Daimler Financial Services Private Limited of Rs. 165.60 millions (as at March 31, 2021: Rs. 175.57 millions, as at March 31, 2020: Rs. 178.66 millions and as at March 31, 2019: Rs. 147.34 millions) carry interest rate ranging from 8.25% p.a. to 10.95 % p.a. repayable in 120 equal monthly instalments by April, 2030. It is secured by way of charge over property building known as Ideal Unique Centre situated at 10 East Topsia Road, Kolkata-700046. It is secured by way Demand Promissory Note along with Letter of Continuity, 6 Undated Blank Cheques in favour of Daimler Financial Services (India) Private Limited and Personal Guarantee of 2 Directors.

(c) Term loan from others of Rs. 154.95 millions (as at March 31, 2021: Rs. 145.22 millions, as at March 31, 2020: Rs. 70.99 millions and as at March 31, 2019: Rs. Nil) carry interest rate in the range of 8.10% p.a. to 9.80% p.a. and will be repaid in equated monthly instalments till February, 2025 are secured by way of hypothecation of demo cars.

(d) Vehicle loan from a bank of Rs. 44.67 millions (as at March 31, 2021: Rs. 54.08 millions, as at March 31, 2020: Rs. 66.95 millions and as at March 31, 2019: Rs. Nil) carry interest rate in the range of 8.55% p.a. to 10.50% p.a. will be repaid in equated monthly instalments by May, 2025 are secured by way of hypothecation of demo cars.

(e) Vehicle loans from others of Rs. Nil (as at March 31, 2021: Rs. Nil, as at March 31, 2020: Rs. Nil and as at March 31, 2019: Rs. 122.12 millions) carry interest rate in the range of 8.75% to 9.85% p.a. and are secured by way of hypothecation of demo cars.

(f) Loan from related parties of Rs. 134.60 Millions (as at March 31, 2021: Rs. 151.40 Millions, as at March 31, 2020: Rs Nil millions and as at March 31, 2019: Rs 168.61 millions) carry interest rate in the range of 8.00% p.a. to 10.20% p.a.

(g) Loan from related parties of Rs. 57.88 millions (as at March 31, 2021: Rs. 44.50 millions, as at March 31, 2020: Rs 76.54 Millions and as at March 31, 2019: Rs Nil millions) carry interest rate in the range of 8.00% to 10.20% p.a. and are repayable on demand.

(h) Working capital loan from Banks outstanding Rs. 582.39 millions (as at March 31, 2021: Rs. 399.42 millions as at March 31, 2020: Rs. 218.87 millions and as at March 31, 2019: Rs. 1,196.39 millions) are primarily secured by pari passu charge by way of hypothecation on all existing and future current assets including spares and consumables and movable fixed assets and equitable mortgage of building at Ahmedabad owned by Landmark Automobiles Private Limited, mortgage of residential building owned by Mr. Sanjay Thakker at Mumbai, personal guarantee of Mr. Sanjay Thakker and corporate guarantee of Landmark Automobiles Private Limited.

(i) Working capital loan from financial institutions amounting to Rs. 1,071.61 millions (as at March 31, 2021: Rs. 518.53 millions as at March 31, 2020: Rs. 497.17 millions and as at March 31, 2019: Rs. 629.93 millions) is secured by the way of undated Security cheques, personal guarantee of two directors and Corporate Guarantee of Parent and exclusive charge on stock and book debts.

(j) Working capital loan from banks amounting to Rs 115.64 millions (as at March 31, 2021: Rs. 24.31 millions, as at March 31, 2020: Rs. 257.17 millions, March 31, 2019: Rs. 40.82 millions) carry interest rate in the range of 9.00% p.a. to 10.00% p.a. and are repayable on demand.

(k) Loan from others of Rs. 391.28 millions (as at March 31, 2021: Rs. 516.69 millions, as at March 31, 2020: Rs. 154.59 millions and as at March 31, 2019: Rs. 98.81 millions) carry interest rate in the range of 8.00% p.a. to 10.00% p.a. and are repayable on demand.

(l) Loan from Kotak Mahindra Prime Limited of Rs. 19.98 millions (as at March 31, 2021: Rs. 19.91 millions, as at March 31, 2020: Rs. Nil and as at March 31, 2019: Rs. Nil) is guaranteed by personal guarantees of two Directors.

(m) Loan from others of Rs. Nil (as at March 31, 2021: Rs. Nil, as at March 31, 2020: Rs. 243.82 millions and as at March 31, 2019: Rs. 91.19 millions) carry interest rate in the range of 8.00% p.a. to 10.20% p.a. and are repayable on or after April 01, 2021.

(n) Loan from Kotak Mahindra Prime Limited of Rs. 50.00 millions (as at March 31, 2021: Rs. Nil, as at March 31, 2020: Rs. Nil and as at March 31, 2019: Rs. Nil) under Emergency Credit Line Guarantee Scheme (ECLGS) repayable in 60 equated monthly instalments by September, 2026 is guaranteed by personal guarantees of two Directors.

**Additional requirements of Amended Schedule III**

In respect of borrowings from banks and financial institutions on the basis of security of current assets, there is no fixed frequency for submission of returns / statements to the banks / financial institutions. The banks / financial institutions conduct their independent stock audit at different intervals for reporting purpose and stock statements were provided that point in time by the Group, which were in agreement with the books of accounts at that point in time. Any adjustments, if identified during the count or any other reasons, are duly adjusted in the books of account subsequently upon notice.

20 Other liabilities

Particulars	As at			
	September 30, 2021	March 31, 2021	March 31, 2020	March 31, 2019
<b>Non-current liabilities</b>				
Contract Liabilities (Refer note below)	66.07	72.27	45.14	40.06
Discount received in advance	-	0.16	1.16	6.63
	<b>66.07</b>	<b>72.43</b>	<b>46.30</b>	<b>46.69</b>
<b>Current liabilities</b>				
Statutory remittances	82.97	64.71	53.79	81.22
Advances received from customers	1,082.07	1,028.43	688.13	742.47
Contract Liabilities (Refer note below)	144.07	131.03	125.37	109.11
Discount received in advance	0.69	1.00	5.84	5.90
Others	-	-	0.31	1.03
	<b>1,309.80</b>	<b>1,225.17</b>	<b>873.44</b>	<b>939.73</b>

Reconciliation of Contract Liabilities

Particulars	As at			
	September 30, 2021	March 31, 2021	March 31, 2020	March 31, 2019
Opening balance	203.30	170.51	149.17	149.04
Add: Advance received during the period/year	145.12	247.05	190.02	165.65
Less: Income recognised during the period/year	138.28	214.26	168.68	165.52
<b>Closing balance</b>	<b>210.14</b>	<b>203.30</b>	<b>170.51</b>	<b>149.17</b>
Contract Liabilities - Non current	66.07	72.27	45.14	40.06
Contract Liabilities - Current	144.07	131.03	125.37	109.11
<b>Total Contract Liabilities</b>	<b>210.14</b>	<b>203.30</b>	<b>170.51</b>	<b>149.17</b>

21 Vehicle floor plan payable

Particulars	As at			
	September 30, 2021	March 31, 2021	March 31, 2020	March 31, 2019
Vehicle floor plan payable	1,252.26	1,183.50	1,778.91	2,279.97
	<b>1,252.26</b>	<b>1,183.50</b>	<b>1,778.91</b>	<b>2,279.97</b>

Vehicle floor plan payable represents amount borrowed to finance the purchase of specific new car inventories with the respective manufacturer's captive finance company. The amount is payable on sale of a specific vehicle or after a pre-defined period (not more than 12 months) if not sold. Such payable amounts are secured by way of first and exclusive charge over specific inventory and further secured by way Demand Promissory Note along with Letter of Continuity, 6 Undated Blank Cheques in favour of the respective finance company and Personal Guarantee of 2 Directors and Corporate Guarantee of Parent. Any amount that remains unpaid after interest free period carries interest in the range of 8.80% to 10.75% p.a. (as at March 31, 2021 ranges from 8.75% to 10.75% p.a., as at March 31, 2020 ranges from 9.75% to 12.75% p.a. and as at March 31, 2019 ranges from 9.75% to 12.75% p.a). Changes in vehicle floor plan payable are reported as operating cash flows.

22 Trade Payables

Particulars	As at			
	September 30, 2021	March 31, 2021	March 31, 2020	March 31, 2019
<b>Current</b>				
Total outstanding dues of micro enterprises and small enterprises	19.41	15.08	14.20	9.91
Total outstanding dues of creditors other than micro enterprises and small enterprises	1,038.37	987.31	542.53	692.69
	<b>1,057.78</b>	<b>1,002.39</b>	<b>556.73</b>	<b>702.60</b>

Notes:

(a) For transactions with related parties, refer note 44.

(b) Information required to be furnished as per Section 22 of the Micro, Small and Medium Enterprises Development Act, 2006 (MSMED Act) and Schedule III of the Companies Act, 2013 for the six months period ended September 30, 2021. This information has been determined to the extent such parties have been identified on the basis of information available with the Group and relied upon by auditors.

Disclosure in respect of Micro and Small Enterprises :

Particulars	As at			
	September 30, 2021	March 31, 2021	March 31, 2020	March 31, 2019
(a) Principal amount and interest due thereon remaining unpaid to any supplier at the end of each accounting year				
Principal	19.41	15.08	14.20	9.91
Interest	-	-	-	-
(b) the amount of interest paid by the buyer in terms of section 16 of the Micro, Small and Medium Enterprises Development Act, 2006, along with the amount of the payment made to the supplier beyond the appointed day during each accounting year	-	-	-	-
(c) the amount of interest due and payable for the period of delay in making payment (which have been paid but beyond the appointed day during the year) but without adding the interest specified under the Micro, Small and Medium Enterprises Development Act, 2006;	-	-	-	-
(d) the amount of interest accrued and remaining unpaid at the end of each accounting year	-	-	-	-
(e) the amount of further interest remaining due and payable even in the succeeding years, until such date when the interest dues above are actually paid to the small enterprise, for the purpose of disallowance of a deductible expenditure under section 23 of the Micro, Small and Medium Enterprises Development Act, 2006.	-	-	-	-

Ageing of Trade Payables

Particulars (Outstanding from due date of payment / from date of transaction)	As at			
	September 30, 2021	March 31, 2021	March 31, 2020	March 31, 2019
<b>(i) MSME</b>				
Less than 1 year	18.54	13.10	12.69	8.99
1-2 years	0.36	1.30	0.08	0.79
2-3 years	0.02	0.57	0.04	0.12
More than 3 years	0.49	-	-	-
	<b>19.41</b>	<b>14.97</b>	<b>12.81</b>	<b>9.90</b>
<b>(ii) Others</b>				
Less than 1 year	909.78	893.27	457.04	623.22
1-2 years	5.94	5.47	11.03	10.23
2-3 years	5.21	4.39	2.62	1.37
More than 3 years	1.45	0.33	0.74	0.44
	<b>922.38</b>	<b>903.46</b>	<b>471.43</b>	<b>635.26</b>
<b>(iii) Disputed dues - MSME</b>				
Less than 1 year	-	-	0.32	-
1-2 years	-	0.11	0.10	0.01
2-3 years	-	-	0.86	-
More than 3 years	-	-	0.11	-
	-	<b>0.11</b>	<b>1.39</b>	<b>0.01</b>
<b>(iv) Disputed dues – Others</b>				
Less than 1 year	-	-	0.18	0.48
1-2 years	-	2.07	0.91	0.01
2-3 years	-	0.28	-	0.11
More than 3 years	-	0.84	0.03	0.14
	-	<b>3.19</b>	<b>1.12</b>	<b>0.74</b>
<b>(iv) Accruals</b>				
Less than 1 year	115.99	80.66	69.98	56.69
1-2 years	-	-	-	-
2-3 years	-	-	-	-
More than 3 years	-	-	-	-
	<b>115.99</b>	<b>80.66</b>	<b>69.98</b>	<b>56.69</b>
	<b>1,057.78</b>	<b>1,002.39</b>	<b>556.73</b>	<b>702.60</b>

23 Other financial liabilities

Particulars	As at			
	September 30, 2021	March 31, 2021	March 31, 2020	March 31, 2019
<b>Current</b>				
Interest accrued	15.77	14.19	18.99	27.76
Book overdraft	-	-	2.08	-
Payable to capital creditors	41.48	35.57	49.11	76.36
	<b>57.25</b>	<b>49.76</b>	<b>70.18</b>	<b>104.12</b>

Landmark Cars Limited (formerly known as Landmark Cars Private Limited)  
Notes to the Restated Consolidated Financial Information  
(All amount in INR Millions unless otherwise stated)

24 Revenue From Operations

Particulars	For the six months period ended	For the year ended		
	September 30, 2021	March 31, 2021	March 31, 2020	March 31, 2019
Sale of cars	11,429.93	14,803.41	16,868.78	22,951.58
Sale of spares, lubricants and others	1,643.66	2,906.72	3,360.86	3,298.51
Sale of services	786.49	1,322.84	1,445.54	1,303.65
<b>Revenue from sale of products and services</b>	<b>13,860.08</b>	<b>19,032.97</b>	<b>21,675.18</b>	<b>27,553.74</b>
Other operating revenues	268.34	528.07	510.96	711.44
	<b>14,128.42</b>	<b>19,561.04</b>	<b>22,186.14</b>	<b>28,265.18</b>

Other operating revenue includes:

Particulars	For the six months period ended	For the year ended		
	September 30, 2021	March 31, 2021	March 31, 2020	March 31, 2019
Finance Commission	44.07	78.31	139.35	193.32
Insurance commission	46.30	61.17	68.66	68.92
Pre-owned cars commission	5.07	5.68	23.25	30.93
Income from schemes and incentives	98.10	260.71	174.15	290.86
Extended Warranty and Road Side Assistance Income	28.01	30.95	22.02	49.42
Others	46.79	91.25	83.53	77.99
	<b>268.34</b>	<b>528.07</b>	<b>510.96</b>	<b>711.44</b>

Reconciliation of the amount of revenue recognised in the statement of profit and loss with the contracted price:

Particulars	For the six months period ended	For the year ended		
	September 30, 2021	March 31, 2021	March 31, 2020	March 31, 2019
Gross revenue	14,290.51	19,864.24	22,401.56	28,437.05
Less: Discounts	162.09	303.20	215.42	171.87
<b>Net Revenue recognized from contract with customers</b>	<b>14,128.42</b>	<b>19,561.04</b>	<b>22,186.14</b>	<b>28,265.18</b>

25 Other Income

Particulars	For the six months period ended	For the year ended		
	September 30, 2021	March 31, 2021	March 31, 2020	March 31, 2019
Interest income on				
Financial assets measured at amortized cost	21.40	39.99	23.86	8.24
Income tax refund	0.02	2.10	2.13	0.01
Security deposits	4.15	8.53	9.59	7.41
Insurance claim (Refer note 48)	5.00	-	2.49	14.80
Sundry balances written back	11.96	31.49	39.20	28.32
Excess provision written back	5.33	0.37	3.18	-
Marketing support income	9.44	18.85	20.42	21.65
Miscellaneous Income	0.28	0.58	2.32	0.48
Profit on sale of property, plant and equipment (net)	0.54	-	-	0.07
Gain on termination of lease	11.39	-	-	-
Gain on sale of current investments	-	0.48	-	-
	<b>69.51</b>	<b>102.39</b>	<b>103.19</b>	<b>80.98</b>

Landmark Cars Limited (formerly known as Landmark Cars Private Limited)  
Notes to the Restated Consolidated Financial Information  
(All amount in INR Millions unless otherwise stated)

26 Purchase of Cars, Spares and others

Particulars	For the six months period ended	For the year ended		
	September 30, 2021	March 31, 2021	March 31, 2020	March 31, 2019
Purchase of cars	11,334.21	14,596.63	15,112.91	22,189.67
Purchase of spares, lubricants and others	1,434.05	2,507.66	2,695.57	2,586.68
	<b>12,768.26</b>	<b>17,104.29</b>	<b>17,808.48</b>	<b>24,776.35</b>

27 Changes in inventories of stock-in-trade

Particulars	For the six months period ended	For the year ended		
	September 30, 2021	March 31, 2021	March 31, 2020	March 31, 2019
<b>Inventories at the end of the year</b>				
Cars	2,879.93	2,402.07	1,811.95	2,952.04
Spares and others	562.96	486.15	445.68	445.92
	<b>3,442.89</b>	<b>2,888.22</b>	<b>2,257.63</b>	<b>3,397.96</b>
<b>Inventories at the beginning of the year</b>				
Cars	2,402.07	1,811.95	2,952.04	2,841.61
Spares and Others	486.15	445.68	445.92	405.34
	<b>2,888.22</b>	<b>2,257.63</b>	<b>3,397.96</b>	<b>3,246.95</b>
<b>Net (Increase) / Decrease</b>	<b>(554.67)</b>	<b>(630.59)</b>	<b>1,140.33</b>	<b>(151.01)</b>

28 Employee Benefits Expense

Particulars	For the six months period ended	For the year ended		
	September 30, 2021	March 31, 2021	March 31, 2020	March 31, 2019
Salaries and wages	637.70	1,017.32	1,283.02	1,370.25
Gratuity Expenses (Refer note 39)	7.54	16.24	16.69	18.54
Contribution to provident and other funds (Refer note 39)	14.55	25.52	28.53	29.87
Share based payment expense (Refer note 45)	0.51	0.01	1.22	54.29
Staff welfare expenses	14.30	17.57	37.93	49.68
	<b>674.60</b>	<b>1,076.66</b>	<b>1,367.39</b>	<b>1,522.63</b>

Landmark Cars Limited (formerly known as Landmark Cars Private Limited)  
Notes to the Restated Consolidated Financial Information  
(All amount in INR Millions unless otherwise stated)

29 Finance costs

Particulars	For the six months period ended	For the year ended		
	September 30, 2021	March 31, 2021	March 31, 2020	March 31, 2019
Interest expense on				
Financial liabilities carried at amortized cost	119.39	240.34	302.93	388.78
Lease liabilities (Refer note 42)	56.36	115.79	129.29	125.01
Delayed payment of income tax	0.01	6.40	-	2.02
Others	2.39	4.66	3.32	1.41
Other borrowing costs	4.06	10.86	13.31	10.41
	<b>182.21</b>	<b>378.05</b>	<b>448.85</b>	<b>527.63</b>

For transaction with related parties, refer note 44

30 Depreciation and amortisation expense

Particulars	For the six months period ended	For the year ended		
	September 30, 2021	March 31, 2021	March 31, 2020	March 31, 2019
Depreciation on property, plant and equipment (Refer Note 5)	122.11	264.50	267.35	238.88
Amortisation of intangible assets (Refer Note 8)	6.71	12.91	12.71	8.61
Amortisation on right of use assets (Refer Note 6)	182.16	347.36	349.46	286.67
	<b>310.98</b>	<b>624.77</b>	<b>629.52</b>	<b>534.16</b>

31 Other expenses

Particulars	For the six months period ended	For the year ended		
	September 30, 2021	March 31, 2021	March 31, 2020	March 31, 2019
Electricity expenses	39.57	60.82	81.26	82.62
Rent (Refer Note 42)	22.55	38.53	63.69	132.18
Rates and taxes	5.52	12.38	12.74	18.46
Repairs expenses				
Repairs to buildings	8.11	21.92	12.50	15.62
Repairs to plant and machineries	2.52	6.64	9.40	11.04
Repairs to others	23.27	33.43	31.30	29.08
Insurance	13.35	27.87	26.55	26.32
Extended warranty and road side assistance expenses	19.22	23.54	30.98	31.93
New car delivery expenses	44.68	63.47	84.20	89.32
Job work charges	120.37	176.36	176.16	173.33
Communication expenses	12.99	26.09	28.03	33.35
Travelling and conveyance	16.50	29.02	54.54	64.11
Printing and stationery	7.95	14.10	17.45	20.36
Charges on credit card transaction	3.41	5.28	8.02	7.16
Commission	18.64	36.98	35.89	51.04
Advertisement and sales promotion	57.53	98.82	191.88	248.57
Donations and Contributions	0.01	0.46	0.15	1.10
Corporate social responsibility expenditure *	2.09	0.59	-	-
Security service charges	21.72	37.02	43.37	40.96
Legal and Professional	28.45	44.60	60.77	71.13
Payments to auditors***	4.20	8.50	6.24	6.55
Software expenses	14.12	29.10	27.89	24.05
Loss on property, plant and equipment sold /written off	5.57	39.97	39.99	12.54
Housekeeping and Pantry expenses	27.19	45.35	67.54	55.76
Franchisee expenses	0.86	1.73	1.73	1.44
Provision for doubtful debts	0.74	1.70	0.64	21.04
Bad trade and others receivables written off	1.44	5.05	9.30	4.66
Miscellaneous expenses	10.65	23.12	18.97	38.20
	<b>533.22</b>	<b>912.44</b>	<b>1,141.18</b>	<b>1,311.92</b>

**Notes to the Restated Consolidated Financial Information**  
(All amount in INR Millions unless otherwise stated)

**\*Corporate social responsibility expenditure**

Particulars	For the six months period ended	For the year ended		
	September 30, 2021	March 31, 2021	March 31, 2020	March 31, 2019
(a) amount required to be spent by the company	2.09	0.59	-	3.20
(b) amount of expenditure incurred (Nature of CSR activities)				
(i) Construction/acquisition of any asset	-	-	-	-
(ii) On purposes other than (i) above	2.09	0.59	-	-
(c) shortfall at the end of the year**,	-	-	-	3.20
(d) total of previous years shortfall,	3.20	3.20	3.20	-
(e) related party transactions	NA	NA	NA	NA
(f) provision, if any	NA	NA	NA	NA

**\*\*Reason for shortfall**

The Company could not spend the money during the year 2018-19, as suitable projects could not be identified. However, members of the Committee are continuously putting their best efforts to work on identify suitable project.

**\*\*\*Payment to auditors (Net of GST credit)**

Particulars	For the six months period ended	For the year ended		
	September 30, 2021	March 31, 2021	March 31, 2020	March 31, 2019
For Statutory Audit #	4.20	8.50	6.20	6.50
For Reimbursement of expenses	-	-	0.04	0.05
	<b>4.20</b>	<b>8.50</b>	<b>6.24</b>	<b>6.55</b>

(# Excluding Rs. 6.00 million for the six months period ended September 30, 2021 which are considered as share issue expenses under other current financial assets)

**32 Earnings/(Loss) Per Share:**

Particulars	For the six months period ended	For the year ended		
	September 30, 2021	March 31, 2021	March 31, 2020	March 31, 2019
Restated profit/(loss) after tax attributable to equity shareholders (Rs. In million)	277.80	113.31	(287.31)	(252.55)
Weighted average number of equity shares for Basic EPS*	3,66,25,620	3,66,25,620	3,66,25,620	3,60,49,904
Add: Effect of ESOP's which are dilutive*	9,28,780	5,25,304	8,988	8,766
Weighted average number of equity shares for Diluted EPS*	3,75,54,400	3,71,50,924	3,66,34,608	3,60,58,670
Nominal value per share (In Rs.)*	5.00	5.00	5.00	5.00
Earnings/(loss) per share				
- Basic (In Rs.) (not annualised for the period ended September 30, 2021)	7.58	3.09	(7.84)	(7.01)
- Diluted (In Rs.) (not annualised for the period ended September 30, 2021)	7.40	3.05	(7.84)	(7.00)

\* Subsequent to September 30, 2021, pursuant to a resolution passed in the extra-ordinary general meeting dated November 10, 2021, Shareholders have approved split of each equity share of face value of Rs. 10 each into two equity shares of face value of Rs 5 each (the "Split"). As required under Ind AS 33 "Earnings per share" the effect of such Split is required to be adjusted for the purpose of computing earnings per share for all the periods presented retrospectively. As a result, the effect of Split has been considered in these Restated Consolidated Financial Information for the purpose of calculation of earnings per share. (Refer note 47)



**33 Income tax expense**

The major component of income tax expenses for the six months period ended September 30, 2021 and for the years ended March 31, 2021, March 31, 2020 and March 31, 2019 are as under:

**33.1 Tax Expense reported in the Restated Consolidated Statement of Profit and Loss**

Particulars	For the six months period ended		For the year ended	
	September 30, 2021	March 31, 2021	March 31, 2020	March 31, 2019
<b>Current income tax</b>				
Current income tax	61.60	103.10	13.53	55.73
Adjustment for previous year taxes	(0.15)	(0.02)	(0.72)	-
<b>Total current income tax</b>	<b>61.45</b>	<b>103.08</b>	<b>12.81</b>	<b>55.73</b>
<b>Deferred tax</b>				
Relating to origination and reversal of temporary differences	(57.59)	(16.75)	30.16	13.03
<b>Tax expense reported in the Restated Consolidated Statement of Profit and Loss</b>	<b>3.86</b>	<b>86.33</b>	<b>42.97</b>	<b>68.76</b>
<b>Tax on Other Comprehensive Income ("OCI")</b>				
Current tax related to items recognised in OCI during the year / period	0.41	-	-	-
Deferred tax related to items recognised in OCI during the year / period	0.58	3.71	-	-
<b>Total tax expense</b>	<b>4.85</b>	<b>90.04</b>	<b>42.97</b>	<b>68.76</b>

**33.2 Balance sheet section**

Particulars	As at			
	September 30, 2021	March 31, 2021	March 31, 2020	March 31, 2019
Income tax assets - Non-Current (net)	12.29	27.38	55.60	48.87
Income tax assets - Current (net)	46.42	14.22	31.15	11.95
Income tax Liabilities - Current (net)	8.47	62.69	7.35	0.54

**33.3 Reconciliation of tax expense and the accounting profit multiplied by India's domestic tax rate**

Particulars	For the six months period ended		For the year ended	
	September 30, 2021	March 31, 2021	March 31, 2020	March 31, 2019
<b>Restated profit / (loss) before tax</b>	<b>284.95</b>	<b>197.81</b>	<b>(246.42)</b>	<b>(175.52)</b>
Tax rate applied	25.17%	25.17%	26.00%	33.38%
Income tax expense / (credit)	71.72	49.78	(64.07)	(58.60)
Tax effect of the amounts which are not deductible / (taxable) in calculating taxable income	0.53	1.92	0.11	0.67
Deduction u/s. 40(a) on the basis of tax deducted (amount disallowed earlier)	-	-	-	0.70
Short / (Excess) provision of tax related to earlier years	(0.15)	(0.02)	(0.72)	0.05
Change in deferred tax balances due to change in income tax rate	0.48	-	(0.40)	1.36
Impact of electing option u/s 115BAA in certain entities of the group	-	0.52	(2.33)	-
Recognition of unrecognised deferred tax assets of earlier years	(59.16)	-	-	-
Difference in tax rates for certain entities of the group	2.30	(0.50)	(0.48)	16.16
Non-Recognition of deferred tax assets on business losses	13.67	39.95	74.23	108.23
Unused tax losses and credits	(23.63)	(8.56)	36.68	-
Effect of amendment in the definition of section 32 as per Finance Act, 2021	-	3.69	-	-
Others	(1.90)	(0.45)	(0.05)	0.19
<b>Tax expense as per Restated Consolidated Statement of Profit and Loss</b>	<b>3.86</b>	<b>86.33</b>	<b>42.97</b>	<b>68.76</b>
<b>Effective tax rate</b>	<b>1.35%</b>	<b>43.64%</b>	<b>-17.44%</b>	<b>-39.18%</b>

Pursuant to the Taxation Law (Amendment) Ordinance, 2019 ("Ordinance") issued by the Ministry of Law and Justice (Legislative Department) on September 20, 2019, effective from April 1, 2019, domestic companies have an option to pay Corporate income tax rate at 22% plus applicable surcharge and cess ("New tax rate") subject to certain conditions. Based on the assessment, Parent and some of its subsidiaries has chosen to exercise the option of New tax rate. Accordingly, those companies have made the provision for current tax and deferred tax at the rate of 25.17% including applicable Surcharge and Cess.

**33.4 Deferred tax balances**

Particulars	As at			
	September 30, 2021	March 31, 2021	March 31, 2020	March 31, 2019
Deferred tax Assets	117.21	56.73	49.03	88.65
Deferred tax Liabilities	12.12	8.65	13.99	23.28
<b>Deferred tax Assets (Net)</b>	<b>105.09</b>	<b>48.08</b>	<b>35.04</b>	<b>65.37</b>

**(A) Deferred Tax Liabilities**

Particulars	Recognized in balance sheet as at			
	September 30, 2021	March 31, 2021	March 31, 2020	March 31, 2019
<b>Deferred Tax Liabilities</b>				
Property, plant and equipment	40.86	39.05	36.86	40.43
<b>Deferred Tax Assets</b>				
Provision for doubtful debts	(0.37)	(0.38)	(0.53)	(2.06)
Unused tax credits	(0.42)	(0.42)	-	-
Unabsorbed depreciation and carried forward business losses	(16.94)	(17.74)	(13.88)	(5.28)
Difference in Right-of-use assets and lease liabilities	(11.01)	(11.86)	(8.46)	(9.81)
<b>Deferred Tax Liabilities (Net)</b>	<b>12.12</b>	<b>8.65</b>	<b>13.99</b>	<b>23.28</b>

33 Income tax expense

(B) Deferred Tax Assets

Particulars	Recognized in balance sheet as at			
	September 30, 2021	March 31, 2021	March 31, 2020	March 31, 2019
<b>Deferred Tax Liabilities</b>				
Property, plant and equipment	(1.77)	0.72	(13.36)	(20.97)
Fair valuation of financial assets	(4.28)	(3.71)	-	-
<b>Deferred Tax Assets</b>				
Disallowance of share issue expenses under section 35D of Income Tax Act, 1961	0.08	0.12	0.41	0.89
Unrealised profit on closing inventories	2.81	1.70	-	-
Provision for doubtful debts	1.86	1.30	2.62	4.42
Unabsorbed depreciation and carried forward business losses	45.36	-	7.85	49.33
MAT Credit Entitlement	40.30	38.09	38.09	38.09
Difference in Right-of-use assets and lease liabilities	32.85	18.51	13.42	16.89
<b>Deferred Tax Assets (Net)</b>	<b>117.21</b>	<b>56.73</b>	<b>49.03</b>	<b>88.65</b>

Movement in Deferred Tax Balances

Particulars	As at April 1, 2018	Adjustments due to Scheme of Arrangement (Refer Note 49)	Recognised in statement of profit and loss	As at March 31, 2019
Property, plant and equipment	42.98	17.29	1.12	61.39
Disallowance of share issue expenses under section 35D of Income Tax Act, 1961	(1.53)	(1.66)	2.30	(0.89)
Provision for doubtful debts	(2.41)	-	(4.07)	(6.48)
Unabsorbed depreciation and brought forward business losses	(74.86)	(6.40)	26.65	(54.61)
MAT credit entitlement	(25.54)	-	(12.55)	(38.09)
Difference in Right-of-use assets and lease liabilities	(26.27)	-	(0.42)	(26.69)
<b>Deferred tax assets (Net)</b>	<b>(87.63)</b>	<b>9.23</b>	<b>13.03</b>	<b>(65.37)</b>
Restatement Adjustments	-	-	-	0.17
<b>Deferred tax assets (Net)</b>				<b>(65.20)</b>

Particulars	As at April 1, 2019	Recognised in statement of profit and loss	Recognised in Other Comprehensive Income	As at March 31, 2020
Property, plant and equipment	61.39	(11.17)	-	50.22
Disallowance of share issue expenses under section 35D of Income Tax Act, 1961	(0.89)	0.48	-	(0.41)
Provision for doubtful debts	(6.48)	3.33	-	(3.15)
Unabsorbed depreciation and brought forward business losses	(54.61)	32.88	-	(21.73)
MAT credit entitlement	(38.09)	-	-	(38.09)
Difference in Right-of-use assets and lease liabilities	(26.52)	4.64	-	(21.88)
<b>Deferred tax assets (Net)</b>	<b>(65.20)</b>	<b>30.16</b>	<b>-</b>	<b>(35.04)</b>

Particulars	As at April 1, 2020	Recognised in statement of profit and loss	Recognised in Other Comprehensive Income	As at March 31, 2021
Property, plant and equipment	50.22	(11.89)	-	38.33
Disallowance of share issue expenses under section 35D of Income Tax Act, 1961	(0.41)	0.29	-	(0.12)
Provision for doubtful debts	(3.15)	1.47	-	(1.68)
Unabsorbed depreciation and brought forward business losses	(21.73)	3.99	-	(17.74)
Unused tax credit	-	(0.42)	-	(0.42)
MAT credit entitlement	(38.09)	-	-	(38.09)
Deferred tax on unrealised profit	-	(1.70)	-	(1.70)
Fair valuation of financial assets	-	-	3.71	3.71
Difference in Right-of-use assets and lease liabilities	(21.88)	(8.49)	-	(30.37)
<b>Deferred tax assets (Net)</b>	<b>(35.04)</b>	<b>(16.75)</b>	<b>3.71</b>	<b>(48.08)</b>

Particulars	As at April 1, 2021	Recognised in statement of profit and loss	Recognised in Other Comprehensive Income	As at September 30, 2021
Property, plant and equipment	38.33	4.29	-	42.62
Disallowance of share issue expenses under section 35D of Income Tax Act, 1961	(0.12)	0.04	-	(0.08)
Provision for doubtful debts	(1.68)	(0.55)	-	(2.23)
Unabsorbed depreciation and brought forward business losses	(17.74)	(44.56)	-	(62.30)
Unused tax credit	(0.42)	-	-	(0.42)
MAT credit entitlement	(38.09)	(2.21)	-	(40.30)
Deferred tax on unrealised profit	(1.70)	(1.11)	-	(2.81)
Fair valuation of preference shares	3.71	-	0.58	4.29
Difference in Right-of-use assets and lease liabilities	(30.37)	(13.49)	-	(43.86)
<b>Deferred tax assets (Net)</b>	<b>(48.08)</b>	<b>(57.59)</b>	<b>0.58</b>	<b>(105.09)</b>

33.5 Details of carry forward losses, deductible temporary difference and unused credit on which no deferred tax asset is recognised by the Group are as follows:

Unabsorbed depreciation can be carried forward indefinitely. Business losses and unused short term capital losses can be carried forward for period of 8 years from the year in which losses arose. Unused business losses will expire between March, 2022 to March, 2029. Unused Short term capital losses will expire in March, 2029.

Deferred tax assets on	As at			
	September 30, 2021	March 31, 2021	March 31, 2020	March 31, 2019
Unused tax losses- related to Depreciation	211.45	276.71	229.91	39.88
Unrecognised deductible temporary differences	126.21	218.97	143.87	82.63
Unused tax losses	327.17	372.98	374.46	222.19
Unused short term capital loss	37.94	37.94	-	-
<b>Total</b>	<b>702.77</b>	<b>906.60</b>	<b>748.24</b>	<b>344.70</b>

**Landmark Cars Limited (formerly known as Landmark Cars Private Limited)**  
**Notes to the Restated Consolidated Financial Information**  
**(All amount in INR Millions unless otherwise stated)**

**34 Financial Instruments**

**34.1 Capital Management**

The Group's capital management objectives are:

- to ensure the Group's ability to continue as going concern
- to provide adequate return to shareholders through optimisation of debt and equity balance.

For the purpose of the Group's capital management, capital includes issued equity capital and other equity reserves attributable to the equity holders of the Group.

The Group manages its capital structure and makes adjustments in light of changes in economic conditions and business opportunities. The Group monitors capital structure using a net debt equity ratio, which is net debt divided by equity.

Particulars	As at	As at	As at	As at March 31, 2019
	September 30, 2021	March 31, 2021	March 31, 2020	
Debt (Refer note (a) below)	4,088.43	3,274.41	3,579.08	4,787.76
Less: Cash and bank balances (Refer note (b) below)	706.20	227.20	333.27	365.68
<b>Adjusted net debt</b>	<b>3,382.23</b>	<b>3,047.21</b>	<b>3,245.81</b>	<b>4,422.08</b>
Total equity	2,085.49	1,817.75	1,691.25	1,879.64
<b>Adjusted net debt to total equity ratio</b>	<b>1.62</b>	<b>1.68</b>	<b>1.92</b>	<b>2.35</b>

**Notes:**

- (a) Debt is defined as long term borrowings, short term borrowings, vehicle floor plan and current maturities of long term borrowings as described in notes 19 and 21 but excludes lease liabilities.
- (b) Cash and bank balances includes cash and cash equivalents and other bank balances held as margin money against guarantees.

**34.2 Disclosure of Financial Instruments by Category**

Particulars	As at September 30, 2021			
	FVTPL	FVTOCI	Amortized cost	Total carrying value
<b>Financial assets</b>				
Investments	-	157.50	-	157.50
Trade receivables	-	-	701.91	701.91
Cash and cash equivalents	-	-	586.95	586.95
Other balances with banks	-	-	119.25	119.25
Loans	-	-	396.38	396.38
Other financial assets	-	-	405.30	405.30
<b>Total Financial assets</b>	-	<b>157.50</b>	<b>2,209.79</b>	<b>2,367.29</b>
<b>Financial liabilities</b>				
Borrowings	-	-	2,836.17	2,836.17
Vehicle floor plan payable	-	-	1,252.26	1,252.26
Trade payables	-	-	1,057.78	1,057.78
Lease liabilities	-	-	1,293.78	1,293.78
Other financial liabilities	-	-	57.25	57.25
<b>Total Financial Liabilities</b>	-	-	<b>6,497.24</b>	<b>6,497.24</b>

Particulars	As at March 31, 2021			
	FVTPL	FVTOCI	Amortized cost	Total carrying value
<b>Financial assets</b>				
Investments	-	129.67	-	129.67
Trade receivables	-	-	557.84	557.84
Cash and cash equivalents	-	-	150.34	150.34
Other balances with banks	-	-	76.86	76.86
Loans	-	-	563.41	563.41
Other financial assets	-	-	401.54	401.54
<b>Total Financial assets</b>	-	<b>129.67</b>	<b>1,749.99</b>	<b>1,879.66</b>
<b>Financial liabilities</b>				
Borrowings	-	-	2,090.91	2,090.91
Vehicle floor plan payable	-	-	1,183.50	1,183.50
Trade payables	-	-	1,002.39	1,002.39
Lease liabilities	-	-	1,359.69	1,359.69
Other financial liabilities	-	-	49.76	49.76
<b>Total Financial Liabilities</b>	-	-	<b>5,686.25</b>	<b>5,686.25</b>

Landmark Cars Limited (formerly known as Landmark Cars Private Limited)  
Notes to the Restated Consolidated Financial Information  
(All amount in INR Millions unless otherwise stated)

Particulars	As at March 31, 2020			
	FVTPL	FVTOCI	Amortized cost	Total carrying value
<b>Financial assets</b>				
Investments	22.50	79.99	-	102.49
Trade receivables	-	-	236.45	236.45
Cash and cash equivalents	-	-	277.01	277.01
Other balances with banks	-	-	56.26	56.26
Loans	-	-	457.11	457.11
Other financial assets	-	-	437.11	437.11
<b>Total Financial assets</b>	<b>22.50</b>	<b>79.99</b>	<b>1,463.94</b>	<b>1,566.43</b>
<b>Financial liabilities</b>				
Borrowings	-	-	1,800.17	1,800.17
Vehicle floor plan payable	-	-	1,778.91	1,778.91
Trade payables	-	-	556.73	556.73
Lease liabilities	-	-	1,471.51	1,471.51
Other financial liabilities	-	-	70.18	70.18
<b>Total Financial Liabilities</b>	<b>-</b>	<b>-</b>	<b>5,677.50</b>	<b>5,677.50</b>

Particulars	As at March 31, 2019			
	FVTPL	FVTOCI	Amortized cost	Total carrying value
<b>Financial assets</b>				
Investments	-	-	-	-
Trade receivables	-	-	783.47	783.47
Cash and cash equivalents	-	-	322.44	322.44
Other balances with banks	-	-	43.24	43.24
Loans	-	-	80.16	80.16
Other financial assets	-	-	601.70	601.70
<b>Total Financial assets</b>	<b>-</b>	<b>-</b>	<b>1,831.01</b>	<b>1,831.01</b>
<b>Financial liabilities</b>				
Borrowings	-	-	2,507.79	2,507.79
Vehicle floor plan payable	-	-	2,279.97	2,279.97
Trade payables	-	-	702.60	702.60
Lease liabilities	-	-	1,586.05	1,586.05
Other financial liabilities	-	-	104.12	104.12
<b>Total Financial Liabilities</b>	<b>-</b>	<b>-</b>	<b>7,180.53</b>	<b>7,180.53</b>

**34.3 Financial Instrument measured at Amortised Cost**

The carrying amount of financial assets and financial liabilities measured at amortised cost in the financial statements are a reasonable approximation of their fair values since the group does not anticipate that the carrying amounts would be significantly different from the values that would eventually be received or settled.

Landmark Cars Limited (formerly known as Landmark Cars Private Limited)  
Notes to the Restated Consolidated Financial Information  
(All amount in INR Millions unless otherwise stated)

35 Fair Value Measurements

35.1 Quantitative disclosures of fair value measurement hierarchy for financial assets and financial liabilities

Particulars	Quoted prices in active markets (Level 1)	Significant observable inputs (Level 2)	Significant unobservable inputs (Level 3)	Total
<b>As at September 30, 2021</b>				
<b>Financial Assets</b>				
Investment in equity investments measured at FVTOCI (Refer Note 9)	-	-	8.19	8.19
Investment in preference shares (Refer Note 9)	-	55.66	93.65	149.31
<b>Total of Financial Assets</b>	-	<b>55.66</b>	<b>101.84</b>	<b>157.50</b>
<b>As at March 31, 2021</b>				
<b>Financial Assets</b>				
Investment in unquoted equity investments measured at FVTOCI (Refer Note 9)	-	8.19	-	8.19
Investment in preference shares (Refer Note 9)	-	93.65	27.83	121.48
<b>Total of Financial Assets</b>	-	<b>101.84</b>	<b>27.83</b>	<b>129.67</b>
<b>As at March 31, 2020</b>				
<b>Financial Assets</b>				
Investment in unquoted equity investments measured at FVTOCI (Refer Note 9)	-	-	*	*
Investment in preference shares (Refer Note 9)	-	79.99	-	79.99
Investment in mutual funds (Refer Note 9)	22.50	-	-	22.50
<b>Total of Financial Assets</b>	<b>22.50</b>	<b>79.99</b>	-	<b>102.49</b>
<b>As at March 31, 2019</b>				
<b>Financial Assets</b>				
Investment in unquoted equity investments measured at FVTOCI (Refer Note 9)	-	-	-	-
Investment in preference shares (Refer Note 9)	-	-	-	-
Investment in mutual funds (Refer Note 9)	-	-	-	-
<b>Total of Financial Assets</b>	-	-	-	-

\* 0.00 denotes figures are below the rounding off norms adopted by the Group

35.2 There are transfers between level 2 and level 3 and vice-versa during the six months period ended September 30, 2021 due to change in categorization based on the lowest level input that is significant to the fair value measurement as a whole. At respective period / year end the financial instruments are categorized as level 2 based on the third party pricing information available and as level 3 in case the lowest level input that is significant to the fair value measurement is unobservable. The Group's policy is to recognise transfers into and transfers out of fair value hierarchy levels as at the end of the reporting period.

35.3 Valuation Methodology

The fair values of investments in mutual fund units is based on the net asset value ('NAV') as stated by the issuers of these mutual fund units in the published statements as at Balance Sheet date. NAV represents the price at which the issuer will issue further units of mutual fund and the price at which issuers will redeem such units from the investors

The Group has measured fair value for Level 2 investment using third party pricing information without adjustments.

The Group has measured fair value for Level 3 investment based on external valuer report.

### 36 Financial Risk Management

The Group's financial liabilities comprise mainly of borrowings, lease liabilities, vehicle floor plan, trade payables and other financial liabilities. The group's financial assets comprise mainly of investments, cash and cash equivalents, other balances with banks, loans given, trade receivables and other financial assets.

The Group's business activities are exposed to a variety of financial risks namely market risk, credit risk and liquidity risk.

The group's senior management has the overall responsibility for establishing and governing the group's risk management framework who are responsible for developing and monitoring the group's risk management policies. The group's risk management policies are established to identify and analyse the risks faced by the group, to set and monitor appropriate risk limits and controls, periodically review the changes in market conditions and reflect the changes in the policy accordingly. The key risks and mitigating actions are also placed before the Board of directors of the Parent. Internal audit undertakes both regular and ad hoc reviews of risk management controls and procedures, the results of which are reported to the Board of directors.

#### 36.1 Market risk

The market risk is the risk that the fair value or future cash flows of a financial instrument will fluctuate because of changes in market prices. Market risk comprises three types of risk: interest rate risk, currency risk and other price risk. The Group does not have any outstanding balance in foreign currencies and hence it is not exposed to foreign currency risk. Financial instruments affected by market risk include loans and borrowings, deposits and investments.

The Group manages market risk through a treasury department, which evaluate and exercises control over the entire process of market risk management.

#### Interest rate risk

Interest rate risk is the risk that the future cash flow with respect to interest payments on borrowing will fluctuate because of change in market interest rates. Interest rate change does not affect significantly short term borrowings therefore the group's exposure to the risk of changes in market interest rates relates primarily to the Group's long-term debt obligation with floating interest rates.

#### 36.2 Liquidity risk

Liquidity risk is defined as the risk that the Group will not be able to settle or meet its obligations on time, or at a reasonable price. The objective of liquidity risk management is to maintain sufficient liquidity and ensure that funds are available for use as per requirements. The group generates cash flows from operations to meet its financial obligations, maintains adequate liquid assets in the form of cash and cash equivalents and has undrawn short term line of credits from banks to ensure necessary liquidity. The group closely monitors its liquidity position and deploys a robust cash management system.

As at period ended September 30, 2021, the Group's current liabilities exceeded its current assets by Rs. 221.83 million which is mainly due to inclusion of current portion of lease liabilities of Rs. 343.53 millions and current portion of contract liabilities pertaining to advance received towards labour portion of annual maintenance contract of Rs. 144.07 millions. The said deficit is expected to be met by the cash to be generated from the operations over the next financial year. Working capital limit of the Group is also expected to remain same over the next financial year and hence the management believes that the Group will be able to meet its financial obligations during next one year.

The following table shows the maturity analysis of the group's financial liabilities based on contractually agreed undiscounted cash flows along with its carrying value as at the Balance Sheet date.

As at September 30, 2021	Carrying Amount	up to 1 year	1-5 years	More than 5 years	Total undiscounted cash flow
<b>Non-Derivative Financial Liabilities</b>					
Borrowings	2,836.17	2,369.29	399.48	67.40	2,836.17
Lease liabilities	1,293.78	424.64	957.01	173.56	1,555.21
Vehicle floor plan payable	1,252.26	1,252.26	-	-	1,252.26
Trade payables	1,057.78	1,057.78	-	-	1,057.78
Other financial liabilities	57.25	57.25	-	-	57.25
<b>Total</b>	<b>6,497.24</b>	<b>5,161.22</b>	<b>1,356.49</b>	<b>240.96</b>	<b>6,758.67</b>

As at March 31, 2021	Carrying Amount	up to 1 year	1-5 years	More than 5 years	Total undiscounted cash flow
<b>Non-Derivative Financial Liabilities</b>					
Borrowings	2,090.91	1,603.24	425.98	61.69	2,090.91
Lease liabilities	1,359.69	429.59	1,010.35	218.72	1,658.66
Vehicle floor plan payable	1,183.50	1,183.50	-	-	1,183.50
Trade payables	1,002.39	1,002.39	-	-	1,002.39
Other financial liabilities	49.76	49.76	-	-	49.76
<b>Total</b>	<b>5,686.25</b>	<b>4,268.48</b>	<b>1,436.33</b>	<b>280.41</b>	<b>5,985.22</b>

As at March 31, 2020	Carrying Amount	up to 1 year	1-5 years	More than 5 years	Total undiscounted cash flow
<b>Non-Derivative Financial Liabilities</b>					
Borrowings	1,800.17	1,518.29	179.18	102.70	1,800.17
Vehicle floor plan payable	1,778.91	1,778.91	-	-	1,778.91
Trade payables	556.73	556.73	-	-	556.73
Lease liabilities	1,471.51	348.32	1,195.87	297.51	1,841.70
Other financial liabilities	70.18	70.18	-	-	70.18
<b>Total</b>	<b>5,677.50</b>	<b>4,272.43</b>	<b>1,375.05</b>	<b>400.21</b>	<b>6,047.69</b>

As at March 31, 2019	Carrying Amount	up to 1 year	1-5 years	More than 5 years	Total undiscounted cash flow
<b>Non-Derivative Financial Liabilities</b>					
Borrowings	2,507.79	2,083.02	300.38	124.39	2,507.79
Vehicle floor plan payable	2,279.97	2,279.97	-	-	2,279.97
Trade payables	702.60	702.60	-	-	702.60
Lease liabilities	1,586.05	416.17	1,187.33	412.44	2,015.94
Other financial liabilities	104.12	104.12	-	-	104.12
<b>Total</b>	<b>7,180.53</b>	<b>5,585.88</b>	<b>1,487.71</b>	<b>536.83</b>	<b>7,610.42</b>

#### 36.3 Credit risk

Credit risk is the risk that counterparty will not meet its obligations under a financial instrument or customer contract, leading to a financial loss. The credit risk for the Group primarily arises from credit exposures to trade receivables, loans given, deposits with landlords for properties taken on leases and other receivables including balances with banks.

Trade and other receivables: The Group's business is predominantly through credit card, cash collections and insurance companies, hence the credit risk on such transactions are minimal. The Group has adopted a policy of dealing with only credit worthy counterparties in case of institutional customers and the credit risk exposure for institutional customers is managed by the Group by credit worthiness checks. All trade receivables are also reviewed and assessed for default on a regular basis. Further, Trade and other receivables consist of a large number of customers hence, the Group is not exposed to concentration risks. In relation to credit risk arising from commercial transactions, necessary provisions are recognized for trade receivables when objective evidence exists that the Group will be unable to recover all the outstanding amounts in accordance with the original contractual conditions of the receivables. Refer note 14 for the disclosures for trade receivables.

The Group also carries credit risk on lease deposits with landlords for properties taken on leases, for which agreements are signed and property possessions timely taken for its operations. The risk relating to refunds after shut down of premises is managed through successful negotiations or appropriate legal actions, where necessary.

Credit risk arising from cash and cash equivalent and other balances with bank is limited as the counterparties are recognised banks.

**Landmark Cars Limited (formerly known as Landmark Cars Private Limited)**  
**Notes to the Restated Consolidated Financial Information**  
**(All amount in INR Millions unless otherwise stated)**

**37 Contingent Liabilities and Commitments (to the extent not provided for)**

Particulars	As at			
	September 30, 2021	March 31, 2021	March 31, 2020	March 31, 2019
<b>Contingent Liabilities</b>				
Matters with GST authorities*	21.96	19.75	-	-
Matters with service tax authorities**	217.24	217.24	212.00	-
Matters with Income Tax authorities	1.30	3.53	3.53	-
Matters with VAT authorities***	6.04	6.04	2.91	2.91
Matters with local authorities	21.45	-	-	-
Corporate guarantees outstanding	1,875.33	1,524.47	2,629.50	2,629.50

\* During the year ended March 31, 2021, the Group has received show-cause notice of Rs. 19.75 Millions for the period July 2017 to March, 2018 for the difference in GST input tax credit between GSTR 3B and GSTR 2A. The Group is still awaiting adjudication from the authorities. The Group has also received order from GST authorities for claiming excess transitional VAT credit of Rs. 0.34 Millions for the period July, 2017 to March, 2018. The Group has received notice from GST authorities of Rs 1.87 Millions for the financial year 2019-20 for carrying invalid e-way bill during the transportation. The Group filed Writ Petition before Honourable Gujarat High court based on Bank Guarantee of Rs. 1.10 Millions.

\*\* During the financial year 2019-20, the Group had received show-cause notice from Central Goods and Service Tax authorities amounting to Rs. 217.20 million pertains to service tax supposed to be levied on the discounts / incentives received from original equipment manufacturers. The Group is still awaiting adjudication from the authorities.

During the financial year 2019-20, the Group had received show-cause notice from Central Goods and Service Tax authorities pertaining to additional service tax liability for the difference in service tax returns and 26 AS issued by the Income tax department amounting to Rs 0.04 millions for the financial year 2014-15. Subsequently, the Group has accepted the service tax liability along with interest and penalty and paid the same.

\*\*\* During the previous year, Mumbai VAT department had raised demand pertaining to non-submission of C forms and F forms and input tax credit mismatch for the year 2016-17 amounting to Rs. 1.63 Millions. Further, during the financial year 2016-17, the Company had received show-cause notice from VAT authorities amounting to Rs 2.91 Millions pertaining to VAT supposed to be levied on handling charges considering to be part of sales consideration. The Company is still awaiting adjudication from the authorities.

For the period April 2017 to June 2017, the Company had received show-cause notice from Madhya Pradesh VAT authorities amounting to Rs 1.50 Millions pertaining to difference in VAT liability in F form. The Company has paid 10% of the demand under dispute amounting to Rs. 0.15 Millions.

Future cash outflows in respect of the above matters are determinable only on receipt of judgements / decisions pending at various forums / authorities. The management is of the view that no liability shall arise on the group for the above matters.

**Capital Commitments**

Particulars	As at			
	September 30, 2021	March 31, 2021	March 31, 2020	March 31, 2019
Estimated amount of Contracts remaining to be executed on capital account and not provided for (net off advances)	4.43	58.90	3.04	0.15

**38 Segment Reporting**

The primary reporting of the Group has been made on the basis of Business Segments. The Group has a single business segment as defined in Indian Accounting Standard (Ind AS) 108 on Segment Reporting, namely dealership of cars in India. The chairman of the group allocates resources and assess the performance of the group, thus are the chief operating decision maker (CODM). The CODM monitors the operating results of the business as a single segment, hence no separate segment needs to be disclosed.

**39 Employee Benefits**

**Defined Contribution Plan:**

The Group makes Provident Fund, Employee State Insurance Scheme and Labour Welfare Fund contributions which are defined contribution plans, for qualifying employees. Under the Schemes, the Group is required to contribute a specified percentage of the payroll costs to fund the benefits. The Group recognized Rs. 8.98 Millions (March 31, 2021 Rs. 15.42 Millions, March 31, 2020 : Rs. 14.92 Millions and March 31, 2019 : Rs 11.86 Millions) for Provident Fund contributions, Rs. 5.48 Millions (March 31, 2021: Rs. 9.91 Millions March 31, 2020 : Rs. 13.38 Millions and March 31, 2019 : Rs. 17.44 Millions) for Employee State Insurance contributions Scheme, Rs. 0.10 Millions (March 31, 2021: Rs. 0.20 Millions, March 31, 2020 : Rs. 0.23 Millions and March 31, 2019 : Rs 0.23 Millions) for Labour Welfare Fund in the Statement of Profit and Loss in Note 28. The contributions payable to these plans by the Group are at rates specified in the rules of the schemes.

**Defined Benefit Plan:**

The Company has a defined benefit gratuity plan (non-funded) and is governed by the Payment of Gratuity Act, 1972. Under the Act, every employee who has completed at least five year of service is entitled to gratuity benefits on departure at 15 days salary (last drawn salary) for each completed year of service. To reduce the overall liabilities on departure, the Group makes monthly payments to employees along with other salary payments which has been expensed out on monthly basis. Each year, the management reviews the balance of payments actually made to the employees while monthly processing, which can be offsetted against the liabilities determined at retirement, death, incapacitation or termination of employment, based on the independent legal opinion obtained by the Group. Such review includes the actual payment - liability matching strategy. The management recognise additional expense to the extent of deficit of actual payment over defined benefit obligations actuarially determined using the Projected Unit Credit method as below.

**Actuarial Assumptions :**

Particulars	As at			
	September 30, 2021	March 31, 2021	March 31, 2020	March 31, 2019
Expected Return on Plan Assets	N.A.	N.A.	N.A.	N.A.
Rate of Discounting	6.26% to 6.42%	4.25%	5.21%	6.66%
Rate of Salary Increase	5.00%	6.00%	6.00%	6.00%
Rate of Employee Turnover	For service 5 years and below 25.00% p.a. For service 5 years and above 5.00% p.a.	30.00%	30.00%	30.00%
Mortality Rate During Employment	Indian Assured Lives Mortality 2012-14 (Urban)	Indian Assured Lives Mortality (2006-08) Ultimate	Indian Assured Lives Mortality (2006-08) Ultimate	Indian Assured Lives Mortality (2006-08) Ultimate

**Movement in Present value of defined benefit obligation :**

Particulars	As at			
	September 30, 2021	March 31, 2021	March 31, 2020	March 31, 2019
<b>Present Value of Defined Benefit Obligation at the Beginning of the year / period</b>	<b>71.47</b>	<b>67.72</b>	<b>65.10</b>	<b>58.74</b>
Interest Cost	1.52	3.53	4.34	4.07
Current Service Cost	6.02	12.71	12.35	14.47
Liability Transferred In	-	0.73	0.80	1.19
Liability Transferred Out	-	(0.54)	(0.81)	(1.22)
Benefit Paid Directly by the Employer	(6.51)	(12.68)	(14.06)	(12.15)
Actuarial (Gains)/Losses on Obligations - Due to Change in Demographic Assumptions	6.88	(0.47)	0.43	(0.54)
Actuarial (Gains)/Losses on Obligations - Due to Change in Financial Assumptions	(18.76)	1.45	2.02	(2.12)
Actuarial (Gains)/Losses on Obligations - Due to Experience	10.25	(0.98)	(2.45)	2.66
<b>Present Value of Defined Benefit Obligation at the End of the year / period</b>	<b>70.87</b>	<b>71.47</b>	<b>67.72</b>	<b>65.10</b>

**Amount recognized in Balance Sheet arising from Defined Benefit Obligation :**

Particulars	As at			
	September 30, 2021	March 31, 2021	March 31, 2020	March 31, 2019
Present Value of Defined Benefit Obligation at the End of the year / period	<b>70.87</b>	<b>71.47</b>	<b>67.72</b>	<b>65.10</b>
Fair Value of Plan Assets at the end of the year / period	-	-	-	-
Actual Payment made to employees during monthly processing, to the extent of actual liabilities (Refer Note above)	(70.87)	(71.47)	(67.72)	(65.10)
<b>Net (Liability)/Asset Recognized in the Balance Sheet</b>	<b>-</b>	<b>-</b>	<b>-</b>	<b>-</b>

**Expenses Recognized in the Statement of Profit or Loss:**

Particulars	For the six months period ended	For the year ended		
	September 30, 2021	March 31, 2021	March 31, 2020	March 31, 2019
Current Service Cost	6.02	12.71	12.35	14.47
Net Interest Cost	1.52	3.53	4.34	4.07
<b>Total</b>	<b>7.54</b>	<b>16.24</b>	<b>16.69</b>	<b>18.54</b>

**Expenses Recognized in the Other Comprehensive Income:**

Particulars	For the six months period ended	For the year ended		
	September 30, 2021	March 31, 2021	March 31, 2020	March 31, 2019
Actuarial (Gains)/Losses on Obligation For the year / period	(1.63)	-	-	-
<b>Total</b>	<b>(1.63)</b>	<b>-</b>	<b>-</b>	<b>-</b>

**Sensitivity Analysis :**

Particulars	As at			
	September 30, 2021	March 31, 2021	March 31, 2020	March 31, 2019
Present value of the defined defined benefit obligation at the end of year / period	70.87	71.47	67.72	65.10
Effect of +1% Change in Rate of Discounting	(5.03)	(1.51)	(1.41)	(1.28)
Effect of -1% Change in Rate of Discounting	5.85	1.61	1.50	1.35
Effect of +1% Change in Rate of Salary Increase	5.68	1.57	1.47	1.23
Effect of -1% Change in Rate of Salary Increase	(4.96)	(1.50)	(1.41)	(1.18)
Effect of +1% Change in Rate of Employee Turnover	0.72	(0.12)	(0.05)	0.07
Effect of -1% Change in Rate of Employee Turnover	(0.81)	0.12	0.05	(0.07)

Compensated absences are not to be carried forward beyond 12 months and are paid per month on the basis of the employee's gross salary.

- 40 The Code on Wages, 2019 and Code of Social Security, 2020 ("the Codes") relating to employee compensation and post-employment benefits had received Presidential assent but the related rules thereof for quantifying the financial impact have not been notified. The Group will assess the impact of the Codes when the rules are notified and will record any related impact in the period the Codes become effective.
- 41 In March, 2020, the World Health Organisation declared COVID-19 to be a pandemic. This pandemic has resulted in disruption to regular business operations due to lockdown, disruptions in transportation, travel bans, quarantines, social distancing and other emergency measures imposed by the government. The Group has adopted measures to curb the spread of infection in order to protect the health of its employees and ensure business continuity with minimal disruption. The Group believes that the COVID 19 pandemic will only have a short term impact on its operations and after easing of the lockdown restrictions, the business is expected to return to normal. Management believes that it has taken into account all the possible impacts of known events arising from COVID-19 pandemic and the resultant lockdowns in the preparation of the financial statements including but not limited to its assessment of Group's liquidity and going concern and recoverable values of its certain financial and non-financial assets. Further, the Group has taken various measures to reduce its fixed costs - for example, salary reductions, requesting of reduction of rental expenses for showrooms and service centres taken on lease and optimization of administrative, sales, marketing and travel costs. Accordingly, the Management believes that the Group will not have any challenge in meeting its financial obligations for the next 12 months based on the current financial position of the Group, business strategies, operating plans of the management. However, given the effect of these lockdowns on the overall economic activity, the impact assessment of COVID-19 on the abovementioned financial statement captions is subject to significant estimation uncertainties given its nature and duration and, accordingly, the actual impacts in future may be different from those estimated as at the date of approval of these financial statements. The Group will continue to closely monitor any material changes to future economic conditions. Further, the pandemic did not have any material impact on the financial statements for the six months period ended September 30, 2021 and years ended March 31, 2021 and March 31, 2020.



**Landmark Cars Limited (formerly known as Landmark Cars Private Limited)**

**Notes to the Restated Consolidated Financial Information**

(All amount in INR Millions unless otherwise stated)

**42 Leases**

**42.1** The Group has lease contracts for its showrooms, workshop premises, plant and equipments and stockyards used in its operations. Leases of the showrooms, workshop premises, plant and equipments and stockyards generally have lease terms between 2 to 10 years.

Lease standard i.e., Ind AS 116 has been notified to be effective w.e.f. April 1, 2019 for accounting of the lease contracts entered in the capacity of a lessee. For the purpose of Restated Consolidated Financial Information, Ind AS 116 has been applied using the modified retrospective approach with effect from April 1, 2018 (i.e. on April 1, 2018 the Group has measured the lease liability at the present value of the remaining lease payments, discounted using the lessee's incremental borrowing rate and a right-of-use asset at its carrying amount as if the standard had been applied since the commencement of the lease, but discounted using the lessee's incremental borrowing rate at the date of April 1, 2019). Accordingly, recognised Right of Use assets and Lease Liability as on April 1, 2018 and difference between Right of Use Assets and Lease Liability, net of deferred tax amounting to Rs. 71.24 millions (Deferred Tax Rs. 11.73 millions) has been adjusted in retained earnings.

There are lease Group contracts that include extension and termination options. The Group also has certain leases of premises with lease terms of 12 months or less and with low value and also leases which expired prior to March 31, 2019. The Group applies the 'short-term lease' and leases which expired prior to March 31, 2019 recognition exemptions for these leases.

**42.2 Maturity Analysis of Lease Liabilities**

Particulars	Carrying amount	up to 1 year	1-5 years	More than 5 years	Total undiscounted cash flow
As at September 30, 2021	1,293.78	424.64	957.01	173.56	1,555.21
As at March 31, 2021	1,359.69	429.59	1,010.35	218.72	1,658.66
As at March 31, 2020	1,471.51	348.32	1,195.87	297.51	1,841.70
As at March 31, 2019	1,586.05	416.17	1,187.33	412.44	2,015.94

**42.3 Lease Liabilities movement**

Particulars	Lease Liability
<b>As at April 1, 2018</b>	<b>1,137.24</b>
Additions during the year	692.58
Interest on lease liabilities	125.01
Payments during the year	(368.78)
<b>As at March 31, 2019</b>	<b>1,586.05</b>
Restatement Adjustments	(5.91)
<b>As at April 1, 2019</b>	<b>1,580.14</b>
Additions during the year	209.03
Interest on lease liabilities	129.29
Payments during the year	(446.95)
<b>As at March 31, 2020</b>	<b>1,471.51</b>
Additions during the year	130.11
Interest on lease liabilities	115.79
Payments during the year	(357.72)
<b>As at March 31, 2021</b>	<b>1,359.69</b>
Additions during the period	167.86
Interest on lease liabilities	56.36
Deduction during the period	(48.26)
Payments during the period	(241.87)
<b>As at September 30, 2021</b>	<b>1,293.78</b>

**42.4** The following are the amounts recognised in the Statement of Profit and Loss:

Particulars	For the six months period ended	For the year ended		
	September 30, 2021	March 31, 2021	March 31, 2020	March 31, 2019
Interest on Lease Liabilities	56.36	115.79	129.29	125.01
Amortisation of ROU Assets	182.16	347.36	349.46	286.67
Expense related to Short-term Leases	22.55	38.53	63.69	132.18

**42.5** Amount Recognised in Statement of Cash Flows

Particulars	For the six months period ended	For the year ended		
	September 30, 2021	March 31, 2021	March 31, 2020	March 31, 2019
Total cash outflow for leases	(241.87)	(357.72)	(446.95)	(368.78)

**43 First time adoption of Ind AS - mandatory exceptions and optional exemptions**

The Group has voluntarily adopted Ind AS for the accounting year beginning from April 1, 2020 with a transition date of April 1, 2019. Accordingly, the consolidated financial statements for the year ended March 31, 2021 together with the comparative information for the year ended March 31, 2020 and opening Ind AS balance sheet as at April 1, 2019 have been prepared in accordance with accounting policies as set out in Note 2 - Significant accounting policies.

Ind AS 101 allows first time adopters certain exemptions and certain optional exceptions from the retrospective application of certain requirements under IND AS as follows:

**Exceptions availed**

**Estimates**

Group's estimates in accordance with Ind AS as at the date of transition to Ind AS are consistent with the estimates made for the same date as per previous GAAP.

**Classification of financial assets**

The classification of financial assets to be measured at amortised cost is made on the basis of the facts and circumstances that existed on the date of transition to Ind AS.

**Exemptions availed**

**Deemed cost for property, plant and equipment and other intangible assets:**

The Group has elected to continue with the carrying value of all of its Property, Plant and Equipment and other intangible assets recognised as of date of transition measured as per the previous GAAP and use that carrying value as its deemed cost as of the transition date to Ind AS.

**Business Combinations:**

The Group has elected not to apply Ind AS 103 retrospectively to past business combinations that occurred before the date of transition to Ind AS. Therefore, the Group has not applied Ind AS 103 for business combinations that have occurred prior to the date of transition to Ind AS.

**Leases:**

Ind AS 116 requires an entity to assess whether a contract or arrangement contains a lease. According to Ind AS 116, this assessment should be carried out at the inception of the contract or arrangement. However, the Group has used Ind AS 101 exemption and assessed all arrangements based on conditions in place as the date of transition.

Group has used following transition exemptions in respect of lease transactions:

- (i) single discount rate has been applied to a portfolio of leases with reasonably similar characteristics.
- (ii) leases for which the lease term was ending within 12 months of the date of transition to Ind AS were accounted as short-term leases.
- (iii) Initial direct costs have been excluded from the measurement of the right-of-use assets.

**Transition to Ind AS - Reconciliations**

The following reconciliation provide the explanation and quantification of the differences arising from the transition from previous GAAP to Ind AS in accordance with Ind AS 101:

- I Reconciliation of Consolidated Balance Sheet previously reported under previous GAAP to Consolidated Statement of Assets and Liabilities under Ind AS as at March 31, 2020 and April 1, 2019.
- II Reconciliation of Consolidated Statement of Profit and Loss previously reported under previous GAAP to Consolidated Statement of Profit and Loss under Ind AS for the years ended March 31, 2020.
- III Adjustments to Consolidated Cash Flow Statement previously reported under previous GAAP to Consolidated Statement of Cash Flows under Ind AS for the years ended March 31, 2020.

## I Reconciliation of Consolidated Balance Sheet as previously reported under previous GAAP to Consolidated Statement of Assets and Liabilities under Ind AS:

Particulars	Notes to first time adoption	As at March 31, 2020			As at April 1, 2019		
		Previous GAAP*	Effect of transition to Ind AS	Ind AS	Previous GAAP*	Effect of transition to Ind AS	Ind AS
<b>ASSETS</b>							
<b>Non-current assets</b>							
Property, plant and equipment		2,114.45	-	2,114.45	2,270.75	-	2,270.75
Right-of-use assets	a	-	1,310.99	1,310.99	-	1,447.41	1,447.41
Capital Work-in-Progress		0.33	-	0.33	-	-	-
Goodwill		231.67	-	231.67	231.67	-	231.67
Other intangible assets		44.60	-	44.60	56.99	-	56.99
Intangible assets under development		6.41	-	6.41	4.38	-	4.38
Financial assets							
Investments		79.99	-	79.99	-	-	-
Loans		308.50	-	308.50	15.29	-	15.29
Other financial assets	a	180.31	(32.28)	148.03	206.55	(37.86)	168.69
Income tax assets (net)		55.60	-	55.60	48.87	-	48.87
Deferred tax assets	c, e	2.27	46.76	49.03	42.74	45.74	88.48
Other non-current assets	c	44.50	(38.09)	6.41	42.72	(38.09)	4.63
<b>Total Non-current assets</b>		<b>3,068.63</b>	<b>1,287.38</b>	<b>4,356.01</b>	<b>2,919.96</b>	<b>1,417.20</b>	<b>4,337.16</b>
<b>Current assets</b>							
Inventories		2,257.63	-	2,257.63	3,397.96	-	3,397.96
Financial assets							
Investments		22.50	-	22.50	-	-	-
Trade receivables	b	249.02	(12.57)	236.45	802.97	(19.50)	783.47
Cash and cash equivalents		277.01	-	277.01	322.44	-	322.44
Other balances with banks		56.26	-	56.26	43.24	-	43.24
Loans		148.61	-	148.61	64.87	-	64.87
Other financial assets		289.08	-	289.08	433.25	-	433.25
Income tax assets (net)		31.15	-	31.15	11.95	-	11.95
Other current assets		642.97	-	642.97	777.78	-	777.78
<b>Total Current assets</b>		<b>3,974.23</b>	<b>(12.57)</b>	<b>3,961.66</b>	<b>5,854.46</b>	<b>(19.50)</b>	<b>5,834.96</b>
<b>Total assets</b>		<b>7,042.86</b>	<b>1,274.81</b>	<b>8,317.67</b>	<b>8,774.42</b>	<b>1,397.70</b>	<b>10,172.12</b>
<b>EQUITY AND LIABILITIES</b>							
<b>EQUITY</b>							
Equity share capital		183.13	-	183.13	183.13	-	183.13
Other equity		1,688.88	(180.76)	1,508.12	1,954.07	(159.86)	1,794.21
Non-controlling interests		8.02	(0.18)	7.84	10.00	(0.08)	9.92
<b>Total Equity</b>		<b>1,880.03</b>	<b>(180.94)</b>	<b>1,699.09</b>	<b>2,147.20</b>	<b>(159.94)</b>	<b>1,987.26</b>
<b>LIABILITIES</b>							
<b>Non-current liabilities</b>							
Financial liabilities							
Borrowings		525.68	-	525.68	456.21	-	456.21
Lease liabilities	a	-	1,233.23	1,233.23	-	1,284.47	1,284.47
Deferred tax liabilities	e	29.75	(15.76)	13.99	45.78	(22.50)	23.28
Other non-current liabilities		46.30	-	46.30	46.69	-	46.69
<b>Total Non-current liabilities</b>		<b>601.73</b>	<b>1,217.47</b>	<b>1,819.20</b>	<b>548.68</b>	<b>1,261.97</b>	<b>1,810.65</b>
<b>Current liabilities</b>							
Financial liabilities							
Borrowings		1,274.49	-	1,274.49	2,051.58	-	2,051.58
Vehicle floor plan payable		1,778.91	-	1,778.91	2,279.97	-	2,279.97
Lease liabilities	a	-	238.28	238.28	-	295.67	295.67
Trade payables							
(a) total outstanding dues of micro enterprises and small enterprises		14.20	-	14.20	9.91	-	9.91
(b) total outstanding dues of creditors other than micro enterprises and small enterprises		542.53	-	542.53	692.69	-	692.69
Other financial liabilities		70.18	-	70.18	104.12	-	104.12
Other current liabilities		873.44	-	873.44	939.73	-	939.73
Current tax liabilities (net)		7.35	-	7.35	0.54	-	0.54
<b>Total Current liabilities</b>		<b>4,561.10</b>	<b>238.28</b>	<b>4,799.38</b>	<b>6,078.54</b>	<b>295.67</b>	<b>6,374.21</b>
<b>Total equity and liabilities</b>		<b>7,042.86</b>	<b>1,274.81</b>	<b>8,317.67</b>	<b>8,774.42</b>	<b>1,397.70</b>	<b>10,172.12</b>

II Reconciliation of Consolidated Statement of Profit and Loss previously reported under previous GAAP to Consolidated Statement of Profit and Loss under Ind AS:

Particulars	Notes to first time adoption	For the year ended March 31, 2020		
		Previous GAAP*	Effect of transition to Ind AS	Ind AS
Revenue from operations		22,186.14	-	22,186.14
Other income	a, b	86.67	16.52	103.19
<b>Total revenue</b>		<b>22,272.81</b>	<b>16.52</b>	<b>22,289.33</b>
<b>Expenses</b>				
Purchase of cars, spares and others		17,808.48	-	17,808.48
Changes in inventories of stock-in-trade		1,140.33	-	1,140.33
Employee benefits expense	d	1,366.20	1.19	1,367.39
Finance costs	a	319.55	129.30	448.85
Depreciation and amortisation expense	a	280.06	349.46	629.52
Other expenses	a, b	1,588.15	(446.97)	1,141.18
<b>Total expenses</b>		<b>22,502.77</b>	<b>32.98</b>	<b>22,535.75</b>
<b>Loss before tax</b>		<b>(229.96)</b>	<b>(16.46)</b>	<b>(246.42)</b>
<b>Tax expense</b>				
Current tax		12.81	-	12.81
Deferred tax	e	24.42	5.74	30.16
<b>Total tax expense</b>		<b>37.23</b>	<b>5.74</b>	<b>42.97</b>
<b>Loss for the year</b>		<b>(267.19)</b>	<b>(22.20)</b>	<b>(289.39)</b>
Other comprehensive income		-	-	-
<b>Total Comprehensive Income for the year</b>		<b>(267.19)</b>	<b>(22.20)</b>	<b>(289.39)</b>

\*Previous GAAP figures have been reclassified to confirm to Ind AS presentation requirements for the purpose of this note.

Notes to Reconciliations

a. Leases:

Under previous GAAP, lease rentals were recognised as an expense after giving straight lining impact. Under Ind AS 116, the lessee shall recognise right of use assets and lease liabilities at the inception of lease. Right of use asset shall be depreciated over the lease period and lease liability shall be classified as financial liability and finance cost shall be charged on it for each reporting period. The above calculated amount is cumulative of depreciation on right- of-use assets, finance cost element and reversal of lease rent expenses.

b. Provision for Expected credit loss on Trade Receivables:

Under previous GAAP, the Group has created provision for impairment of receivables consists only in respect of specific amount for incurred losses. Under Ind AS, the Company has recognised impairment loss on trade receivables based on the expected credit loss model as required by Ind AS 109.

c. Reclassification of MAT Credit Entitlement:

Under previous GAAP, MAT credit entitlement was classified as Other current assets. Under Ind AS, MAT credit entitlement is considered as part of deferred tax component. Accordingly, MAT Credit entitlement have been deducted from the Other current assets and Deferred Tax Liabilities have been shown net off MAT Credit entitlement.

d. Share based payment:

Under the previous GAAP, equity settled employee share-based payments were recognised using the intrinsic value method. Under Ind AS, the cost of equity settled employee share-based payments is recognised based on the fair value of the options as on the grant date. The effect of these is reflected in Total Equity and / or in Restated Consolidated Statement of Profit and Loss, as applicable.

e. Deferred tax:

The various transitional adjustments have led to temporary differences and accordingly, the Group has accounted for such differences. Deferred tax adjustments are recognised in correlation to the underlying transaction either in retained earnings or a separate component of equity.

III Reconciliation of statement of cash flows

The IND AS adjustments are either non cash adjustments or are regrouping among the cash flows from operating, investing and financing activities. Consequently, IND AS adoption has no impact on the net cash flow for the year ended March 31, 2020 as compared with the previous GAAP.

44 Related party transactions

Name of the parties and its relationships

Sr. No.	Description of Relationship	Name of Related Parties
a.	Enterprise over which key management Personnel and it's relatives are able to exercise significant influence and control	Wild Dreams Media and Communications Private Limited Landmark Commercial Vehicles Private Limited (Up to September 30, 2018) Adorn Studio LLP Landmark Insurance Brokers Private Limited Landmark Pre-Owned Cars Private Limited Demarc
b.	Key Management Personnel	Mr. Sanjay K Thakker Mr. Aryaman S Thakker * Mrs. Ami S Thakker Mr. Mayank Bajpay (Up to December 10, 2020) Mr. Paras Somani Mr. Akshay Tanna (w.e.f December 10, 2020) Mr. Surendra Agarwal (Chief Financial Officer)
c.	Relatives of Key Management Personnel	Sanjay Thakker (HUF) Udayan K Thakker (HUF) Mr. Udayan K Thakker (Brother of Mr. Sanjay K Thakker) Mrs. Smita A Mody (Mother of Ami S Thakker) Mr. Krish Somani (Son of Paras Somani) Mrs. Falguni Somani (Spouse of Paras Somani) Ms. Aparajita S Thakker (Daughter of Mr. Sanjay K Thakker) Mr. Aryaman S Thakker (Son of Mr. Sanjay K Thakker)* Ms. Urvi Mody (Sister of Ami S Thakker)
d.	Enterprises exercising significant influence over the Group	TPG Growth II SF Pte. Ltd.

\* With effect from December 10, 2020, Mr. Aryaman S Thakker has been designated as Key Management Personnel

DISCLOSURE OF TRANSACTIONS BETWEEN THE GROUP AND RELATED PARTIES AND THE STATUS OF OUTSTANDING BALANCES AS AT SEPTEMBER 30, 2021, MARCH 31, 2021, MARCH 31, 2020 and MARCH 31, 2019

Sr.No.	RELATED PARTY TRANSACTIONS SUMMARY	For the six months period ended		For the year ended	
		September 30, 2021	March 31, 2021	March 31, 2020	March 31, 2019
	<b>Part 1 : Transactions during the year</b>				
	<b>Advertisement Expenses</b>				
1	Adorn Studio LLP	-	-	0.07	0.58
	Wild Dreams Media and Communications Private Limited	10.73	13.42	30.73	42.28
	<b>Purchase of spares and services</b>				
2	Landmark Commercial Vehicles Private Limited (Up to September 30, 2018)	-	-	-	0.02
	Landmark Pre-Owned Cars Private Limited	-	18.83	0.11	0.17
	<b>Interest Paid</b>				
3	Sanjay K Thakker	2.00	10.20	6.41	5.99
	Aryaman S Thakker	0.11	1.12	0.74	0.81
	Sanjay Thakker (HUF)	0.51	2.28	0.32	1.96
	Aparajita S Thakker	0.12	0.89	0.40	0.34
	Urvi Mody	0.32	0.25	0.25	-
	Smita A Mody	0.12	0.59	0.08	-
	Landmark Commercial Vehicles Private Limited (Up to September 30, 2018)	-	-	-	0.97
	Ami S Thakker	1.76	8.75	3.08	5.05
	<b>Reimbursement of expenses</b>				
4	Paras Somani	0.09	0.14	0.40	0.55
	Sanjay K Thakker	-	-	0.02	0.11
	Aryaman S Thakker	-	-	0.36	0.03
	Udayan K Thakker	0.06	0.09	0.09	-
	Urvi Mody	-	-	0.06	0.04
	<b>Remuneration</b>				
5	Sanjay K Thakker	5.30	7.49	10.93	9.91
	Aparajita S Thakker	-	1.63	0.83	-
	Ami S Thakker	1.56	2.33	5.90	8.79
	Aryaman S Thakker	1.66	2.00	1.26	1.98
	Paras Somani	5.14	8.16	8.94	14.47
	Surendra Agarwal	2.90	5.78	5.80	5.11
	Urvi Mody	2.16	4.02	4.53	4.53
	<b>Rent expense</b>				
6	Udayan K Thakker	0.46	0.92	0.77	-
	Sanjay Thakker (HUF)	0.17	0.34	0.29	-
	Udayan K Thakker (HUF)	0.24	0.48	0.40	-
	<b>Sale of spares and services</b>				
7	Paras Somani	-	-	0.02	0.21
	Aryaman S Thakker	-	-	-	0.00
	Landmark Pre-Owned Cars Private Limited	-	2.62	8.96	11.16

**Landmark Cars Limited (formerly known as Landmark Cars Private Limited)**  
**Notes to the Restated Consolidated Financial Information**  
**(All amount in INR Millions unless otherwise stated)**

Sr.No.	RELATED PARTY TRANSACTIONS SUMMARY	For the six months period ended		For the year ended	
		September 30, 2021	March 31, 2021	March 31, 2020	March 31, 2019
8	<b>Loans Taken</b>				
	Sanjay K Thakker	160.50	234.40	58.40	44.08
	Sanjay Thakker (HUF)	19.10	14.00	7.00	0.40
	Smita A Mody	3.00	2.50	6.50	-
	Ami S Thakker	132.20	157.10	26.00	24.10
	Aryaman S Thakker	8.50	5.00	1.50	9.20
	Urvi Mody	1.50	7.50	13.50	-
	Aparajita S Thakker	7.00	7.70	3.50	5.20
9	<b>Loans Repaid</b>				
	Sanjay K Thakker	172.06	140.20	128.43	40.20
	Ami S Thakker	135.95	97.60	83.60	23.20
	Aryaman S Thakker	5.00	9.50	1.90	6.30
	Smita A Mody	-	8.50	-	-
	Urvi Mody	-	13.50	-	-
	Sanjay Thakker (HUF)	13.30	20.25	8.74	0.20
	Aparajita Sanjay Thakker	7.70	9.20	0.30	0.90
10	<b>Purchase of Property, Plant and Equipment</b>				
Landmark Pre-owned Cars Private Limited	-	-	-	0.79	
11	<b>Deposit Given (rent)</b>				
	Sanjay Thakker (HUF)	-	-	0.13	-
	Udayan K Thakker (HUF)	0.05	-	0.52	-
12	<b>Commission Income</b>				
	Landmark Pre-owned Cars Private Limited	-	2.15	-	-
	Krish Somani	-	0.21	-	-
	Landmark Insurance Brokers Private Limited	11.41	22.57	12.52	0.05
	Falguni Somani	-	0.60	-	-
13	<b>Shared based payment expense</b>				
	Paras Somani	-	-	0.38	16.97
	Urvi Mody	-	-	0.05	2.26
	Surendra Agarwal	0.22	0.00	-	-
14	<b>Other Support Service Income</b>				
	Landmark Pre-Owned Cars Private Limited	-	-	4.10	20.16
	Landmark Commercial Vehicles Private Limited (Up to September 30, 2018)	-	-	-	5.10

**Compensation of key management personnel:**

The remuneration of key management personnel during the year was as follows:

Particulars	For the six months period ended		For the year ended	
	September 30, 2021	March 31, 2021	March 31, 2020	March 31, 2019
Short-term employee benefits	16.55	24.59	31.99	33.17
<b>Total</b>	<b>16.55</b>	<b>24.59</b>	<b>31.99</b>	<b>33.17</b>

Part 2 : Balance at the end of the year		As at			
		September 30, 2021	March 31, 2021	March 31, 2020	March 31, 2019
1	<b>Trade Payables</b>				
	Landmark Pre-Owned Cars Private Limited	-	-	-	0.07
	Wild Dreams Media and Communications Private Limited	3.15	3.23	6.39	14.20
	Sanjay K Thakker	-	0.80	1.04	0.12
	Ami S Thakker	-	0.32	0.35	0.18
	Paras Somani	-	1.24	-	2.34
	Urvi Mody	-	0.86	0.49	0.13
	Krish Somani	0.04	-	-	-
	Aparajita S Thakker	-	0.22	0.23	-
	Sanjay K Thakker (HUF)	0.03	-	-	-
Aryaman S Thakker	-	0.24	0.33	-	
2	<b>Trade Receivables</b>				
	Krish Somani	-	0.13	-	-
	Falguni Somani	-	0.11	-	-
	Landmark Commercial Vehicles Private Limited (Up to September 30, 2018)	-	-	-	2.75
	Wild Dreams Media and Communications Private Limited	0.03	-	-	-
	Landmark Insurance Brokers Private Limited	-	1.54	-	-
Landmark Pre-Owned Cars Private Limited	-	-	0.01	10.89	
3	<b>Borrowings including Interest accrued</b>				
	Sanjay K Thakker	79.50	91.06	4.66	69.45
	Sanjay Thakker (HUF)	19.10	13.30	21.35	21.33
	Aparajita S Thakker	7.00	7.70	9.87	6.30
	Smita A Mody	5.50	2.50	9.04	-
	Urvi Mody	7.78	7.50	13.72	-
	Ami S Thakker	65.10	68.85	7.89	61.47
	Aryaman S Thakker	8.50	5.00	10.37	10.06

\* 0.00 denotes figures are below the rounding off norms adopted by the Group

**Notes:**

The amount outstanding are unsecured and will be settled in cash. No expense has been recognised in the current or prior years for bad or doubtful debts in respect of amounts owed by related parties.

For guarantees given by promoter's, refer footnote to note 19

The following are the details of the transactions eliminated on consolidation as per Ind AS 24 read with ICDR Regulations during the period/year ended September 30, 2021, March 31, 2021, March 31, 2020 and March 31, 2019

(i) Transaction by the Parent with other Group Companies

Name of the Party and Relationships

Sr. No.	Description of Relationship	Name of Related Parties
a.	Subsidiary Companies	Landmark Cars (East) Private Limited Landmark Commercial Vehicles Private Limited Automark Motors Private Limited Landmark Automobiles Private Limited Watermark Cars Private Limited Landmark Lifestyle Cars Private Limited Benchmark Motors Private Limited

Sr.No	Particulars	For the six months period ended		For the year ended	
		September 30, 2021	March 31, 2021	March 31, 2020	March 31, 2019
<b>Part 1 : Transactions during the year</b>					
1	<b>Sale of Goods, Spares and Services</b>				
	Landmark Cars (East) Private Limited	0.05	0.29	25.10	4.67
	Landmark Automobiles Private Limited	0.13	0.01	5.98	-
	Landmark Commercial Vehicles Private Limited	-	-	0.00	-
	Landmark Lifestyle Cars Private Limited	0.06	0.09	-	-
	Benchmark Motors Private Limited	0.05	-	-	-
	Automark Motors Private Limited	0.06	-	3.99	-
2	<b>Purchase of Cars, Spares and Services</b>				
	Benchmark Motors Private Limited	1.26	1.62	-	-
	Landmark Cars (East) Private Limited	0.33	23.47	42.37	29.90
	Landmark Automobiles Private Limited	-	1.66	-	-
	Watermark Cars Private Limited	44.77	42.07	-	-
	Automark Motors Private Limited	0.02	0.04	-	0.12
Landmark Commercial Vehicles Private Limited	-	-	0.00	-	
3	<b>Purchase of Property, Plant and Equipment</b>				
	Landmark Automobiles Private Limited	-	-	0.85	-
	Benchmark Motors Private Limited	-	0.00	-	-
	Landmark Lifestyle Cars Private Limited	-	0.01	-	-
	Watermark Cars Private Limited	-	0.01	0.01	-
4	<b>Sales of Property, plant and equipment</b>				
Benchmark Motors Private Limited	0.05	-	-	-	
5	<b>Sale of Property, Plant and Equipment</b>				
Benchmark Motors Private Limited	-	-	-	0.04	
6	<b>Interest Income</b>				
	Landmark Cars (East) Private Limited	3.58	10.91	17.28	15.01
	Benchmark Motors Private Limited	5.16	6.74	10.55	7.99
	Landmark Lifestyle Cars Private Limited	4.95	7.45	0.64	0.13
	Landmark Automobiles Private Limited	-	0.12	-	-
	Automark Motors Private Limited	0.11	0.57	0.02	-
	Landmark Commercial Vehicles Private Limited	4.29	3.45	0.12	-
Watermark Cars Private Limited	2.82	6.14	7.40	5.22	
7	<b>Labour Expenses</b>				
	Automark Motors Private Limited	-	-	0.04	0.12
	Landmark Commercial Vehicles Private Limited	-	-	-	2.55
Landmark Automobiles Private Limited	-	0.02	0.01	0.02	
8	<b>Loans Given</b>				
	Landmark Cars (East) Private Limited	648.36	1,151.76	1,674.81	2,065.86
	Benchmark Motors Private Limited	289.70	550.90	203.00	68.20
	Landmark Lifestyle Cars Private Limited	90.50	625.91	117.00	100.00
	Landmark Automobiles Private Limited	-	40.00	-	-
	Automark Motors Private Limited	82.50	139.71	26.00	-
	Landmark Commercial Vehicles Private Limited	127.50	151.10	69.50	-
	Watermark Cars Private Limited	152.90	17.50	87.70	29.70
9	<b>Loans Repaid</b>				
	Landmark Cars (East) Private Limited	648.36	1,229.02	1,730.95	2,063.50
	Benchmark Motors Private Limited	163.80	472.72	310.69	7.50
	Landmark Lifestyle Cars Private Limited	226.70	407.25	112.50	100.00
	Automark Motors Private Limited	26.20	160.74	5.00	-
	Landmark Commercial Vehicles Private Limited	8.70	79.10	61.00	-
	Landmark Automobiles Private Limited	-	40.00	-	-
Watermark Cars Private Limited	152.00	179.96	12.10	15.70	
10	<b>Advertisement Income</b>				
	Landmark Lifestyle Cars Private Limited	-	0.02	-	-
Benchmark Motors Private Limited	0.18	0.37	-	-	
11	<b>Other Support Service Income</b>				
	Landmark Lifestyle Cars Private Limited	18.08	27.25	15.94	0.51
	Automark Motors Private Limited	20.88	32.61	27.70	1.50
	Watermark Cars Private Limited	-	1.12	1.49	-
	Landmark Commercial Vehicles Private Limited	5.53	6.73	3.89	-
	Landmark Automobiles Private Limited	74.05	120.78	59.68	-
Benchmark Motors Private Limited	15.57	27.31	15.00	0.09	
12	<b>Rent Income</b>				
Landmark Lifestyle Cars Private Limited	1.50	1.25	-	-	

Landmark Cars Limited (formerly known as Landmark Cars Private Limited)  
Notes to the Restated Consolidated Financial Information  
(All amount in INR Millions unless otherwise stated)

Part 2 : Balance at the end of the period

Sr.No	Particulars	As at			
		September 30, 2021	March 31, 2021	March 31, 2020	March 31, 2019
	<b>Trade Payables</b>				
1	Landmark Lifestyle Cars Private Limited	-	0.01	-	-
	Benchmark Motors Private Limited	-	0.00	-	-
	Landmark Commercial Vehicles Private Limited	-	0.00	-	-
	Automark Motors Private Limited	0.01	0.02	-	0.02
	Landmark Cars (East) Private Limited	-	-	0.09	-
	Landmark Automobiles Private Limited	-	0.05	-	0.02
	<b>Loans Given</b>				
2	Landmark Cars (East) Private Limited	92.70	93.97	171.23	227.36
	Benchmark Motors Private Limited	246.70	117.88	39.70	137.89
	Automark Motors Private Limited	56.30	-	21.02	-
	Landmark Commercial Vehicles Private Limited	123.38	80.50	8.54	-
	Landmark Lifestyle Cars Private Limited	91.16	223.73	5.08	-
	Watermark Cars Private Limited	3.44	-	162.46	80.20
	<b>Corporate Guarantees Outstanding</b>				
3	Benchmark Motors Private Limited	350.23	218.09	733.00	733.00
	Landmark Automobiles Private Limited	386.08	147.46	-	-
	Landmark Commercial Vehicles Private Limited	298.96	230.04	-	-
	Landmark Cars (East) Private Limited	450.97	429.68	884.00	884.00
	Landmark Lifestyle Cars Private Limited	624.27	428.06	875.00	875.00
	Watermark Cars Private limited	-	-	137.50	137.50
	Automark Motors Private Limited	146.30	71.13	-	-
	<b>Other receivables</b>				
4	Landmark Lifestyle Cars Private Limited	-	2.83	1.82	0.30
	Automark Motors Private Limited	-	4.08	0.16	0.71
	Landmark Automobiles Private Limited	-	16.51	0.04	0.30
	Benchmark Motors Private Limited	-	3.05	3.83	-
	Watermark Cars Private Limited	-	-	0.33	-
	Landmark Cars (East) Private Limited	-	-	-	0.09
	Landmark Commercial Vehicles Private Limited	-	1.02	0.05	3.64

(ii) Transaction by Automark Motors Private Limited with other Group Companies

Name of the Party and Relationships

Sr. No.	Description of Relationship	Name of Related Parties
a.	Holding Company	Landmark Cars Limited
b.	Fellow Subsidiaries - Subsidiaries of Landmark Cars Limited	Landmark Automobiles Private Limited Landmark Commercial Vehicles Private Limited Landmark Lifestyle Cars Private Limited Watermark Cars Private Limited Landmark Cars (East) Private Limited Benchmark Motors Private Limited

Sr. No	Particulars	For the six months period ended		For the year ended	
		September 30, 2021	March 31, 2021	March 31, 2020	March 31, 2019
<b>Part 1 : Transactions during the year</b>					
	<b>Sale of Goods/services</b>				
1	Landmark Commercial Vehicles Private Limited	-	0.01	0.05	0.02
	Landmark Automobiles Private Limited	-	0.02	-	-
	Landmark Lifestyle Cars Private Limited	-	-	-	0.00
	Landmark Cars Limited	0.02	0.04	0.04	0.12
	<b>Sale of Property, Plant and Equipment</b>				
2	Landmark Lifestyle Cars Private Limited	0.02	0.01	-	2.89
	Benchmark Motors Private Limited	0.08	-	2.45	2.02
	Watermark Cars Private Limited	-	-	-	0.37
	Landmark Automobiles Private Limited	-	-	0.01	-
	<b>Purchase of Property, Plant and Equipment</b>				
3	Landmark Automobiles Private Limited	-	-	0.01	-
	Watermark Cars Private Limited	-	0.02	-	-
	<b>Purchase of Goods/Services</b>				
4	Landmark Automobiles Private Limited	0.12	22.45	0.00	0.01
	Landmark Lifestyle Cars Private Limited	0.02	0.04	-	-
	Landmark Cars Limited	0.06	-	3.99	-
	<b>Manpower services</b>				
5	Landmark Cars Limited	20.88	32.61	27.70	-
	Landmark Commercial Vehicles Private Limited	-	-	-	1.50
	<b>Interest expense</b>				
6	Landmark Cars Limited	0.11	0.57	0.02	-
	<b>Loans Taken</b>				
7	Landmark Cars Limited	82.50	139.71	26.00	-
	<b>Loans Repaid</b>				
8	Landmark Cars Limited	26.20	160.73	5.00	-



Landmark Cars Limited (formerly known as Landmark Cars Private Limited)  
Notes to the Restated Consolidated Financial Information  
(All amount in INR Millions unless otherwise stated)

**Part 2 : Balance at the end of the period**

Sr. No	Particulars	As at			
		September 30, 2021	March 31, 2021	March 31, 2020	March 31, 2019
1	<b>Trade payables</b> Landmark Cars Limited	-	4.06	21.18	-
2	<b>Trade Receivables</b> Landmark Cars Limited Landmark Commercial Vehicles Private Limited	0.01	0.01	- 0.07	0.31 -
3	<b>Loans Taken</b> Landmark Cars Limited	56.30	-	21.02	-
4	<b>Receivable on sale of property, plant and equipment</b> Benchmark Motors Private Limited Landmark Lifestyle Cars Private Limited	- -	- -	- -	2.40 3.45

**(iii) Transaction by Benchmark Motors Private Limited with other Group Companies**

**Name of the Party and its Relationships**

Sr. No.	Description of Relationship	Name of Related Parties
a.	Holding Company	Landmark Cars Limited
b.	Fellow Subsidiaries - Subsidiaries of Landmark Cars Limited	Landmark Automobiles Private Limited Landmark Cars (East) Private Limited Landmark Commercial Vehicles Private Limited Landmark Lifestyle Cars Private Limited Watermark Cars Private Limited Automark Motors Private Limited

Sr. No.	Particulars	For the six months period ended	For the year ended		
		September 30, 2021	March 31, 2021	March 31, 2020	March 31, 2019
<b>Part 1 : Transactions during the year</b>					
1	<b>Other Support service income</b> Landmark Cars Limited	1.26	1.62	-	-
2	<b>Rent Income</b> Landmark Lifestyle Cars Private Limited	3.39	0.76	-	-
3	<b>Purchase of Goods</b> Landmark Lifestyle Cars Private Limited Landmark Cars Limited Watermark Cars Private Limited	- 0.05 -	- - 0.04	- - -	0.01 - -
4	<b>Sale of accessories and service</b> Landmark Lifestyle Cars Private Limited	0.22	-	-	-
5	<b>Advertisement Expenses</b> Landmark Cars Limited	0.18	0.37	-	-
6	<b>Manpower expenses</b> Landmark Cars Limited	15.57	27.31	15.00	-
7	<b>Loans Taken</b> Landmark Cars Limited	289.70	550.90	203.00	68.20
8	<b>Loans Repaid</b> Landmark Cars Limited Landmark Commercial Vehicles Private Limited	163.80 -	472.72 -	310.69 18.25	7.50 -
9	<b>Interest Paid</b> Landmark Cars Limited Landmark Commercial Vehicles Private Limited	5.16 -	6.74 -	10.55 0.42	7.99 0.97
10	<b>Sale of Property, Plant and Equipment</b> Landmark Lifestyle Cars Private Limited Landmark Automobiles Private Limited	- 0.12	- -	- 0.01	0.37 -
11	<b>Purchase of Property, Plant and Equipment</b> Landmark Cars Limited Automark Motors Private Limited Watermark Cars Private Limited	0.05 0.08 -	- - 7.58	- 2.45 0.23	0.04 2.02 -

**Part 2 : Balance at the end of the year**

Sr. No.	Particulars	As at			
		September 30, 2021	March 31, 2021	March 31, 2020	March 31, 2019
1	<b>Trade payables</b> Automark Motors Private Limited Landmark Cars Limited Watermark Cars Private Limited	- - -	- 3.05 -	- 3.83 0.09	2.40 - -
2	<b>Trade Receivables</b> Landmark Lifestyle Cars Private Limited	0.12	0.83	0.14	0.42
3	<b>Borrowings</b> Landmark Cars Limited Landmark Commercial Vehicles Private Limited	246.70 -	117.88 -	39.70 -	137.89 18.25

Landmark Cars Limited (formerly known as Landmark Cars Private Limited)  
Notes to the Restated Consolidated Financial Information  
(All amount in INR Millions unless otherwise stated)

(iv) Transaction by Landmark Cars (East) Private Limited with other Group Companies

Name of the Party and its Relationships

Sr. No.	Description of Relationship	Name of Related Parties
a.	Holding Company	Landmark Cars Limited
b.	Fellow Subsidiary- Subsidiaries of Landmark Cars Limited	Landmark Commercial Vehicles Private Limited Automark Motors Private Limited Benchmark Motors Private Limited Landmark Lifestyle Cars Private Limited Landmark Automobiles Private Limited

Sr. No.	Particulars	For the six months period ended		For the year ended	
		September 30, 2021	March 31, 2021	March 31, 2020	March 31, 2019
<b>Part 1 : Transactions during the year</b>					
1	<b>Sale of Goods/Services</b> Landmark Cars Limited	0.33	23.47	42.37	29.90
2	<b>Purchase of Goods</b> Landmark Cars Limited	0.05	0.29	25.10	4.67
3	<b>Interest paid</b> Landmark Cars Limited	3.58	10.91	17.28	15.01
4	<b>Loans Taken</b> Landmark Cars Limited	648.36	1,151.76	1,674.81	2,065.86
5	<b>Loans Repaid</b> Landmark Cars Limited	648.36	1,229.02	1,730.93	2,063.50
6	<b>Purchase of Property, Plant and Equipment</b> Landmark Commercial Vehicles Private Limited	-	-	-	0.86

Part 2 : Balance at the end of the year

Sr. No.	Particulars	As at			
		September 30, 2021	March 31, 2021	March 31, 2020	March 31, 2019
1	<b>Trade payables</b> Landmark Cars Limited	-	-	-	0.09
2	<b>Borrowings</b> Landmark Cars Limited	92.70	93.97	171.23	227.36
3	<b>Trade receivable</b> Landmark Cars Limited	-	-	0.09	-

(v) Transaction by Landmark Commercial Vehicles Private Limited with other Group Companies

Name of the Party and its Relationships

Sr. No.	Description of Relationship	Name of Related Parties
a	Holding Company	Landmark Cars Limited
b	Fellow Subsidiaries - Subsidiaries of Landmark Cars Limited	Landmark Automobiles Private Limited Automark Motors Private Limited Landmark Cars (East) Private Limited Benchmark Motors Private Limited Landmark Lifestyle Cars Private Limited Watermark Cars Private Limited

Sr.No.	Particulars	For the six months period ended		For the year ended	
		September 30, 2021	March 31, 2021	March 31, 2020	March 31, 2019
<b>Part 1 : Transactions during the year</b>					
1	<b>Interest received</b> Benchmark Motors Private Limited	-	-	0.42	0.97
2	<b>Sale of Property, Plant and Equipment</b> Landmark Automobiles Private Limited	-	-	0.01	0.22
3	<b>Other expenses</b> Landmark Cars Limited Automark Motors Private Limited	- -	- 0.01	0.00 0.06	0.29 -
4	<b>Sale of Vehicles</b> Landmark Cars (East) Private Limited	-	-	-	0.86
5	<b>Sale of scrap</b> Landmark Cars Limited	-	-	0.00	-
6	<b>Purchase of goods/service</b> Landmark Automobiles Private Limited	0.01	-	-	-
7	<b>Manpower expenses</b> Landmark Cars Limited	5.53	6.73	3.89	-
8	<b>Interest paid</b> Landmark Cars Limited	4.29	3.45	0.12	-
9	<b>Borrowings</b> Landmark Cars Limited	127.50	151.10	69.50	-
10	<b>Repayment of borrowings</b> Landmark Cars Limited	87.00	79.10	61.00	-
11	<b>Loans Repaid</b> Benchmark Motors Private Limited	-	-	18.25	-

Landmark Cars Limited (formerly known as Landmark Cars Private Limited)  
Notes to the Restated Consolidated Financial Information  
(All amount in INR Millions unless otherwise stated)

Part 2 : Balance at the end of the year

Sr. No.	Particulars	As at			
		September 30, 2021	March 31, 2021	March 31, 2020	March 31, 2019
1	<b>Loans Given</b>				
	Benchmark Motors Private Limited	-	-	-	18.25
2	<b>Borrowings</b>				
	Landmark Cars Limited	123.38	80.50	8.54	-
3	<b>Trade payables</b>				
	Landmark Cars Limited	-	1.02	0.05	3.64
	Automark Motors Private Limited	-	-	0.07	-

(vi) Transaction by Landmark Lifestyle Cars Private Limited with other Group Companies

Name of the Party and its Relationships

Sr. No.	Description of Relationship	Name of Related Parties
a.	Holding Company	Landmark Cars Limited
b.	Fellow Subsidiaries - Subsidiaries of Landmark Cars Limited	Automark Motors Private Limited Benchmark Motors Private Limited Automark Motors Private Limited Watermark Cars Private Limited Landmark Commercial Vehicles Private Limited Landmark Cars (East) Private Limited

Sr.No.	Particulars	For the six months period ended	For the year ended		
		September 30, 2021	March 31, 2021	March 31, 2020	March 31, 2019
<b>Part 1 : Transactions during the year</b>					
1	<b>Loans Taken</b>				
	Landmark Cars Limited	90.50	625.91	117.00	100.00
2	<b>Loans Repaid</b>				
	Landmark Cars Limited	226.70	399.80	112.50	100.00
3	<b>Interest paid</b>				
	Landmark Cars Limited	4.95	7.45	0.64	0.13
4	<b>Marketing Expenses / Other Services</b>				
	Landmark Cars Limited	-	0.02	-	-
	Landmark Commercial Vehicles Private Limited	-	-	-	1.39
5	<b>Manpower Services</b>				
	Landmark Cars Limited	18.08	27.25	15.94	-
6	<b>Purchase of Goods/Services</b>				
	Landmark Cars Limited	0.06	0.09	-	-
	Automark Motors Private Limited	-	-	-	0.00
	Benchmark Motors Private Limited	0.22	-	-	-
	Landmark Automobiles Private Limited	-	0.06	-	-
7	<b>Sale of Goods/Services</b>				
	Automark Motors Private Limited	0.02	0.04	-	-
	Benchmark Motors Private Limited	-	-	-	0.01
8	<b>Sale of Property, plant and equipment</b>				
	Landmark Cars Limited	-	0.01	-	-
9	<b>Purchase of Property, plant and equipment</b>				
	Benchmark Motors Private Limited	-	-	-	0.37
	Automark Motors Private Limited	0.02	0.01	-	2.89
11	<b>Rent expense</b>				
	Landmark Cars Limited	1.50	1.25	-	-
	Benchmark Motors Private Limited	3.30	0.76	-	-

Part 2 : Balance at the end of the year

Sr.No.	Particulars	As at			
		September 30, 2021	March 31, 2021	March 31, 2020	March 31, 2019
1	<b>Borrowings</b>				
	Landmark Cars Limited	91.16	223.73	5.08	-
2	<b>Trade Payables</b>				
	Benchmark Motors Private Limited	0.12	0.83	0.14	0.42
	Landmark Commercial Vehicles Private Limited	-	-	-	0.23
	Landmark Cars Limited	-	2.83	1.82	-
	Automark Motors Private Limited	-	-	-	3.45
3	<b>Trade Receivables</b>				
	Landmark Cars Limited	-	0.01	-	-

Landmark Cars Limited (formerly known as Landmark Cars Private Limited)  
Notes to the Restated Consolidated Financial Information  
(All amount in INR Millions unless otherwise stated)  
(vii) Transaction by Watermark Cars Private Limited with other Group Companies

**Name of the Party and its Relationships**

Sr. No.	Description of Relationship	Name of Related Parties
a	Holding Company	Landmark Cars Limited
b	Fellow Subsidiaries - Subsidiaries of Landmark Cars Limited	Landmark Automobiles Private Limited Landmark Commercial Vehicles Private Limited Automark Motors Private Limited Benchmark Motors Private Limited Landmark Cars East Private limited Landmark Lifestyle Cars Private Limited

Sr. No	Particulars	For the six months period ended	For the year ended		
		September 30, 2021	March 31, 2021	March 31, 2020	March 31, 2019
<b>Part 1: Transactions during the year</b>					
<b>1</b>	<b>Loans Taken</b>				
	Landmark Cars Limited	152.90	17.50	87.70	29.70
<b>2</b>	<b>Loans Repaid</b>				
	Landmark Cars Limited	152.00	179.96	12.10	15.70
<b>3</b>	<b>Interest paid</b>				
	Landmark Cars Limited	2.82	6.14	7.40	5.22
<b>4</b>	<b>Reimbursement of salary and wages</b>				
	Landmark Cars Limited	-	1.12	1.49	-
<b>5</b>	<b>Sale of property, plant and equipment</b>				
	Landmark Cars Limited	-	0.01	0.01	-
	Benchmark Motors Private Limited	-	7.58	0.22	-
	Landmark Automobiles Private Limited	-	0.62	0.01	-
	Automark Motors Private Limited	-	0.02	-	-
<b>6</b>	<b>Purchase of Property, Plant and Equipment</b>				
	Landmark Automobiles Private Limited	-	-	-	0.09
	Automark Motors Private Limited	-	-	-	0.37
<b>7</b>	<b>Sale of Cars</b>				
	Landmark Automobiles Private Limited	-	-	0.70	-
<b>8</b>	<b>Sales of Accessories</b>				
	Landmark Cars Limited	44.77	42.07	-	-
	Benchmark Motors Private Limited	-	0.04	-	-
	Landmark Automobiles Private Limited	0.02	0.02	-	-
<b>9</b>	<b>Purchase of Accessories</b>				
	Landmark Automobiles Private Limited	5.06	4.49	-	-

**Part 2: Balance at the end of the year**

Sr. No	Particulars	As at			
		September 30, 2021	March 31, 2021	March 31, 2020	March 31, 2019
<b>1</b>	<b>Borrowings</b>				
	Landmark Cars Limited	3.44	-	162.46	80.20
<b>2</b>	<b>Trade Payables</b>				
	Landmark Automobiles Private Limited	0.15	0.24	-	0.44
	Landmark Cars Limited	-	-	0.33	-
<b>3</b>	<b>Trade Receivables</b>				
	Benchmark Cars Private Limited	-	-	0.09	-

## (viii) Transaction by Landmark Automobiles Private Limited with other Group Companies

## Name of the Party and its Relationships

Sr. No.	Description of Relationship	Name of Related Parties
a.	Holding Company	Landmark Cars Limited
b.	Fellow Subsidiaries - Subsidiaries of Landmark Cars Limited	Automark Motors Private Limited Landmark Commercial Vehicles Private Limited Landmark Cars (East) Private Limited Landmark Lifestyle Cars Private Limited Watermark Cars Private Limited Benchmark Motors Private Limited

## Part 1 : Transactions during the year

Sr. No.	Particulars	For the year ended			
		For the six months period ended September 30, 2021	March 31, 2021	March 31, 2020	March 31, 2019
<b>Part 1 : Transactions during the year</b>					
<b>1</b>	<b>Purchase of accessories/services</b>				
	Landmark Cars Limited	0.13	0.01	-	-
	Watermark Cars Private Limited	0.02	0.02	-	-
	Automark Motors Private Limited	-	0.02	-	-
	<b>Purchase of Property, Plant and Equipment</b>				
	Landmark Commercial Vehicles Private Limited	-	-	0.01	0.22
	Landmark Cars Limited	-	-	5.98	-
	Automark Motors Private Limited	-	-	0.02	-
	Benchmark Motors Private Limited	0.12	-	0.01	-
	Watermark Cars Private Limited	-	0.62	0.72	-
<b>3</b>	<b>Manpower Services</b>				
	Landmark Cars Limited	74.05	118.45	57.25	-
<b>4</b>	<b>Other Expenses</b>				
	Landmark Cars Limited	-	-	-	0.30
	<b>Sale of Accessories</b>				
	Automark Motors Private Limited	0.12	22.45	0.01	0.01
	Landmark Cars Limited	-	1.68	0.01	0.02
	Watermark Cars Private Limited	5.06	4.49	-	-
	Landmark Commercial Vehicles Private Limited	0.01	-	-	-
	Landmark Lifestyle Cars Private Limited	-	0.06	-	-
<b>6</b>	<b>Loans Taken</b>				
	Landmark Cars Limited	-	40.00	-	-
	<b>Sale of Property, Plant and Equipment</b>				
	Benchmark Motors Private Limited	-	-	-	0.03
	Watermark Cars Private Limited	-	-	-	0.09
	Landmark Cars Limited	-	-	0.85	-
<b>8</b>	<b>Interest Paid</b>				
	Landmark Cars Limited	-	0.12	-	-
<b>9</b>	<b>Loans Repaid</b>				
	Landmark Cars Limited	-	40.00	-	-

## Part 2 : Balance at the end of the year

Sr. No.	Particulars	As at			
		September 30, 2021	March 31, 2021	March 31, 2020	March 31, 2019
<b>1</b>	<b>Trade payables</b>				
	Landmark Cars Limited	-	16.51	0.04	0.30
	<b>Trade Receivable</b>				
<b>2</b>	Watermark Cars Private Limited	0.15	0.24	-	-
	Landmark Cars Limited	-	0.05	-	0.02
<b>3</b>	<b>Guarantees Outstanding</b>				
	Landmark Commercial Vehicles Private Limited	-	-	200.30	200.30

**Landmark Cars Limited (formerly known as Landmark Cars Private Limited)**  
**Notes to the Restated Consolidated Financial Information**  
**(All amount in INR Millions unless otherwise stated)**

**45 Employee stock option plan**

**45.1** The Group has a share option scheme for certain employees of the group. In accordance with the terms of the share option scheme, as approved by shareholders at Extra Ordinary General Meeting held on April 6, 2018, employees with a pre defined grade may be granted options to purchase equity shares. Each share option converts into one equity share of the group on exercise.

No amounts are paid or payable by the recipient on receipt of the option. The options carry neither rights to dividends nor voting rights. Options may be exercised within in four years from the date of grant, as per vesting schedule. The share options vests based on a pre-determined vesting schedule from the date of grant. The fair value of the share options is estimated at the grant date using a black Scholes pricing model, taking into account the terms and conditions upon which the share options are granted. However, the above performance condition is only considered in determining the number of instruments that will ultimately vest. There are no cash settlement alternatives. The group does not have a past practice of cash settlement for these share options.

**45.2 During the six months period ended September 30, 2021, following stock option grants were in operation:**

Particulars	Details	
	April 9, 2018	March 29, 2021
Date of Grant	8,79,023	16,000
No. of options granted	Equity	Equity
Method of Settlement	1 Year from the grant date	1 Year from the grant date
Vesting period	3 years from the date of vesting *	3 years from the date of vesting
Exercise Period	Continuous service	Continuous service
Vesting conditions	233.50	333.00
Exercise price per option (Rs.)	63.15	63.15
Fair value of option (Rs.)		

\*Subsequent to September 30, 2021, pursuant to a resolution in the board meeting dated October 28, 2021, Board of directors have approved extension of the exercise period by additional one year.

**45.3 Assumptions used for fair valuation of Options:**

Particulars	Details
Risk free rate of return	7.12%
Sigma	13.62%

**45.4 Movement in stock options during the year**

Particulars	As at			
	September 30, 2021	March 31, 2021	March 31, 2020	March 31, 2019
<b>Employee Stock Option Movement (Numbers)</b>				
Opening Balance	8,95,023	8,79,023	8,79,023	-
Granted during the period/year	-	16,000	-	8,79,023
Closing Balance	8,95,023	8,95,023	8,79,023	8,79,023

Particulars	As at			
	September 30, 2021	March 31, 2021	March 31, 2020	March 31, 2019
<b>Employee Stock Option Reserve Movement (Amount in Millions)</b>				
Opening Balance	55.52	55.51	54.29	-
Add: Compensation charge for the period/year	0.51	0.01	1.22	54.29
Closing Balance	56.03	55.52	55.51	54.29

**45.5 Share options exercised during the year**

There are no share options exercised during the period/year.

**45.6 Expense arising from share based payment transactions**

Particulars	For the six months period ended	For the year ended		
	September 30, 2021	March 31, 2021	March 31, 2020	March 31, 2019
Employee stock option plan	0.51	0.01	1.22	54.29
<b>Total</b>	<b>0.51</b>	<b>0.01</b>	<b>1.22</b>	<b>54.29</b>

Landmark Cars Limited (formerly known as Landmark Cars Private Limited)  
Notes to the Restated Consolidated Financial Information  
(All amount in INR Millions unless otherwise stated)

46 Additional information pursuant to schedule III of the Companies Act 2013

Name of the entities	As at September 30, 2021		As at March 31, 2021		As at March 31, 2020		As at March 31, 2019	
	Net Assets / (Liabilities) i.e. total assets minus liabilities		Net Assets / (Liabilities) i.e. total assets minus liabilities		Net Assets / (Liabilities) i.e. total assets minus liabilities		Net Assets / (Liabilities) i.e. total assets minus liabilities	
	As % of consolidated net assets	Amount	As % of consolidated net assets	Amount	As % of consolidated net assets	Amount	As % of consolidated net assets	Amount
<b>Parent</b>								
Landmark Cars Limited	125.63%	2,629.95	137.80%	2,513.09	138.45%	2,352.50	119.39%	2,256.19
<b>Indian subsidiaries</b>								
Landmark Cars (East) Private Limited	2.16%	45.19	1.94%	35.36	2.71%	46.13	3.11%	58.37
Landmark Commercial Vehicles Private Limited	3.15%	65.91	3.12%	56.96	1.56%	26.49	2.08%	39.21
Automark Motors Private Limited	22.87%	478.64	26.95%	491.58	26.03%	442.23	21.28%	402.08
Landmark Automobiles Private Limited	23.28%	487.29	23.00%	419.43	19.84%	337.09	17.54%	331.46
Watermark Cars Private Limited	-7.26%	-151.99	-9.18%	(167.45)	-8.41%	(142.95)	-3.74%	(70.64)
Landmark Lifestyle Cars Private Limited	-1.07%	-22.48	-6.83%	(124.59)	-7.44%	(126.48)	-0.31%	(5.82)
Benchmark Motors Private Limited	-14.27%	-298.60	-13.49%	(246.02)	-14.13%	(240.05)	-6.88%	(129.94)
Less: Adjustment arising out of consolidation	-54.86%	-1,148.42	-63.64%	(1,160.61)	-59.07%	(1,003.71)	-52.99%	(1,001.27)
Add: Non Controlling Interest in Subsidiaries	0.37%	7.68	0.33%	6.01	0.46%	7.84	0.52%	9.92
<b>Total</b>	<b>100.00%</b>	<b>2,093.17</b>	<b>100.00%</b>	<b>1,823.76</b>	<b>100.00%</b>	<b>1,699.09</b>	<b>100.00%</b>	<b>1,889.56</b>

Name of the entities	For the six months ended September 30, 2021					
	Share in profit / (loss)		Share in other comprehensive income		Share in total comprehensive income	
	As % of consolidated net profit/ (loss)	Amount	As % of consolidated other comprehensive income	Amount	As % of consolidated other comprehensive income	Amount
<b>Parent</b>						
Landmark Cars Limited	45.92%	126.93	100.00%	3.17	46.31%	130.10
<b>Indian subsidiaries</b>						
Landmark Cars (East) Private Limited	2.93%	8.17	-	-	2.91%	8.17
Landmark Commercial Vehicles Private Limited	3.21%	8.95	-	-	3.18%	8.95
Automark Motors Private Limited	-4.64%	(12.95)	-	-	-4.61%	(12.95)
Landmark Automobiles Pvt Ltd	24.32%	67.85	-	-	24.15%	67.85
Watermark Cars Private Limited	5.54%	15.47	-	-	5.50%	15.47
Landmark Lifestyle Cars Private Limited	36.60%	102.11	-	-	36.34%	102.11
Benchmark Motors Private Limited	-18.85%	(52.59)	-	-	-18.72%	(52.59)
Less: Adjustment arising out of consolidation	4.37%	12.19	-	-	4.34%	12.19
Add: Non-Controlling Interest in Subsidiaries	0.60%	1.67	-	-	0.60%	1.67
<b>Total</b>	<b>100.00%</b>	<b>277.80</b>	<b>100.00%</b>	<b>3.17</b>	<b>100.00%</b>	<b>280.97</b>

Landmark Cars Limited (formerly known as Landmark Cars Private Limited)  
Notes to the Restated Consolidated Financial Information  
(All amount in INR Millions unless otherwise stated)

Name of the entities	For the year ended 31st March 2021					
	Share in profit / (loss)		Share in other comprehensive income		Share in total comprehensive income	
	As % of consolidated net profit/ (loss)	Amount	As % of consolidated other comprehensive income	Amount	As % of consolidated other comprehensive income	Amount
<b>Parent</b>						
Landmark Cars Limited	130.79%	148.20	94.76%	12.49	127.03%	160.69
<b>Indian subsidiaries</b>						
Landmark Cars (East) Private Limited	-9.51%	(10.78)	-	-	-8.52%	(10.78)
Landmark Commercial Vehicles Private Limited	18.07%	20.48	-	-	16.19%	20.48
Automark Motors Private Limited	43.56%	49.36	-	-	39.02%	49.36
Landmark Automobiles Pvt Ltd	72.58%	82.24	-	-	65.02%	82.24
Watermark Cars Private Limited	-21.62%	(24.50)	-	-	-19.37%	(24.50)
Landmark Lifestyle Cars Private Limited	-42.47%	(48.12)	-	-	-38.04%	(48.12)
Benchmark Motors Private Limited	-94.13%	(106.66)	5.24%	0.69	-83.78%	(105.97)
Less: Adjustment arising out of consolidation	1.11%	1.26	-	-	1.00%	1.26
Add: Non-Controlling Interest in Subsidiaries	1.62%	1.83	-	-	1.45%	1.83
<b>Total</b>	<b>100.00%</b>	<b>113.31</b>	<b>100.00%</b>	<b>13.18</b>	<b>100.00%</b>	<b>126.49</b>

Name of the entities	For the year ended March 31, 2020					
	Share in profit / (loss)		Share in other comprehensive income		Share in total comprehensive income	
	As % of consolidated net profit/ (loss)	Amount	As % of consolidated other comprehensive income	Amount	As % of consolidated other comprehensive income	Amount
<b>Parent</b>						
Landmark Cars Limited	0.63%	(1.81)	-	-	0.63%	(1.81)
<b>Indian subsidiaries</b>						
Landmark Cars (East) Private Limited	4.26%	(12.24)	-	-	4.26%	(12.24)
Landmark Commercial Vehicles Private Limited	4.43%	(12.72)	-	-	4.43%	(12.72)
Automark Motors Private Limited	-13.81%	39.68	-	-	-13.81%	39.68
Landmark Automobiles Pvt Ltd	-1.96%	5.62	-	-	-1.96%	5.62
Watermark Cars Private Limited	25.17%	(72.31)	-	-	25.17%	(72.31)
Landmark Lifestyle Cars Private Limited	42.07%	(120.86)	-	-	42.07%	(120.86)
Benchmark Motors Private Limited	38.32%	(110.11)	-	-	38.32%	(110.11)
Less: Adjustment arising out of consolidation	1.61%	(4.64)	-	-	1.61%	(4.64)
Add: Non-Controlling Interest in Subsidiaries	-0.72%	2.08	-	-	-0.72%	2.08
<b>Total</b>	<b>100.00%</b>	<b>(287.31)</b>	<b>-</b>	<b>-</b>	<b>100.00%</b>	<b>(287.31)</b>



**Landmark Cars Limited (formerly known as Landmark Cars Private Limited)**  
**Notes to the Restated Consolidated Financial Information**  
**(All amount in INR Millions unless otherwise stated)**

Name of the entities	For the year ended March 31, 2019					
	Share in profit / (loss)		Share in other comprehensive income		Share in total comprehensive income	
	As % of consolidated net profit/ (loss)	Amount	As % of consolidated other comprehensive income	Amount	As % of consolidated other comprehensive income	Amount
<b>Parent</b>						
Landmark Cars Limited	-1.80%	4.55	-	-	-1.81%	4.55
<b>Indian subsidiaries</b>						
Landmark Cars (East) Private Limited	-19.28%	48.70	-	-	-19.27%	48.70
Landmark Commercial Vehicles Private Limited	2.85%	(7.21)	-	-	2.85%	(7.21)
Automark Motors Private Limited	2.84%	(7.17)	-	-	2.84%	(7.17)
Landmark Automobiles Pvt Ltd	-15.19%	38.35	-	-	-15.19%	38.35
Watermark Cars Private Limited	28.24%	(71.32)	-	-	28.24%	(71.32)
Landmark Lifestyle Cars Private Limited	32.62%	(82.37)	-	-	32.62%	(82.37)
Benchmark Motors Private Limited	47.55%	(120.08)	-	-	47.55%	(120.08)
Less: Adjustment arising out of consolidation	18.90%	(47.73)	-	-	18.90%	(47.73)
Add: Non-Controlling Interest in Subsidiaries	3.27%	(8.27)	-	-	3.27%	(8.27)
<b>Total</b>	<b>100.00%</b>	<b>(252.55)</b>	-	-	<b>100.00%</b>	<b>(252.55)</b>

**47 Events occurred after the Balance Sheet Date**

- a. Pursuant to the resolution of board meeting dated October 28, 2021 and January 11, 2022, the Company has issued 31,000 Employee Stock Options (Face value of Rs. 10 each) and 12,000 Employee Stock Options (Face Value of Rs 5 each) respectively under ESOS Scheme.
- b. The Shareholders in their extra ordinary general meeting dated November 10, 2021 approved sub-division of each equity shares of face value Rs. 10 into two equity shares of face value of Rs. 5 each.
- c. Pursuant to the business transfer agreement dated September 18, 2021 amongst the Parent, Shaman Wheels Private Limited and their promoters', the Parent has acquired the business of servicing Mercedes Benz vehicles (including maintenance, repairs and warranty work/services through its network of identified four facilities) from Shaman Wheels Private Limited (the "Business Undertaking") with effect from October 1, 2021. The purchase consideration of the said transaction will be determined based on the performance of the Business Undertaking over next six months starting from October 1, 2021.
- d. Pursuant to the letter of intent between Watermark Cars Private Limited (WCPL), a subsidiary company and BYD India Private Limited dated November 30, 2021, WCPL will become dealer in the National Capital Region (Delhi) and Mumbai region in respect of their electric passenger vehicles.
- e. With effect from October 1, 2021, our dealership agreement with Mercedes-Benz India Private Limited (hereinafter referred to as "Mercedes-Benz") materially changed and converted to an agency model whereby all car sales will now be made directly to customers by Mercedes-Benz. Under this agency model, we will no longer purchase cars from Mercedes-Benz and re-sell them to the customers. Rather, customers will now place orders through us directly to Mercedes-Benz and our Companies will earn commission on each sale of Mercedes-Benz made through us. This modus operandi will have an impact on Landmark Cars Limited, Holding Company and Landmark Cars (East) Private Limited, one of the Subsidiary Company.
- f. The Group evaluates events and transactions that occur subsequent to the balance sheet date but prior to the approval of financial statements to determine the necessity for recognition and/or reporting of subsequent events and transactions in the financial statements. As of January 17, 2022 there were no subsequent events and transactions to be recognized or reported that are not already disclosed.

**48 Loss due to fire**

On October 29, 2020, there was a fire at Andheri workshop premises of the Benchmark Motors Private Limited, a subsidiary company resulting into a loss of property, plant and equipment and inventories of spare parts and accessories. The subsidiary company has insurance policies of all the affected assets with a reputed insurance company. The estimated carrying value of the property, plant and equipment is Rs. 8.79 Million and estimated cost of inventory of spares and accessories is of Rs. 3.77 Million for which loss has been accounted for in the books of accounts during the year ended March 31, 2021.

Considering the reinstatement clause mentioned in the policy, the subsidiary company lodges the claim with insurance company as and when work gets completed. Based on partial assessment, insurance company has released partial payment of Rs. 5 Million which has been accounted as income for the period ended September 30, 2021 and for remaining amount income will be recognised as and when assessment gets completed by insurance company. (Refer Note 25)

On November 5, 2017, there was a fire in the Workshop at Rajkot location of Automark Motors Private Limited, a subsidiary company resulting into partial loss of furniture fixtures, office equipments, spare parts and plant and machineries. The claim income of Rs. 14.80 million for the year ended March 31, 2019 and Rs. 1.60 million for the year ended March 31, 2020 were accounted for in the books as insurance income.

**Landmark Cars Limited (formerly known as Landmark Cars Private Limited)**  
**Notes to the Restated Consolidated Financial Information**  
**(All amount in INR Millions unless otherwise stated)**

**49 Scheme of Arrangement**

During the financial year 2018-19, the Group had carried out business combinations through composite schemes of arrangement and amalgamation for the identified businesses, which was approved by NCLT with the various appointed dates falling within the financial year 2018-19. Under the schemes, the total assets and liabilities of dealership businesses of Landmark Automobiles Private Limited (Honda brand), Autamark Motors Private Limited (Volkswagen brand) and Landmark Commercial Vehicles Private Limited (Ashok Leyland brand) was acquired against the issuance of equity shares of the Parent to their respective shareholders.

These transactions had been accounted under Indian GAAP and on transition to Ind-AS, the Group has opted for optional exemption for not applying retrospectively Ind AS 103 accounting principles for business combinations that occurred before the transition date i.e. April 1, 2019. However, for the purpose of preparing the Special Purpose Consolidated Ind AS Financial Statements, the Group has accounted the said transactions applying the principals of Appendix C of Ind AS 103 considering the transition date as April 1, 2018.

Particulars	Reference	Honda	Volkswagen	Ashok Leyland	Total Amount
Appointed Date as per Scheme of Arrangement		April 1, 2018	April 1, 2018	October 1, 2018	
Total Assets acquired	A	1,127.26	826.53	436.48	2,390.27
Total Liability acquired	B	814.56	403.21	377.37	1,595.14
Preference shares of the group companies acquired back	C	500.00	10.00	-	510.00
Net Assets Acquired	D = (A-B+C)	812.70	433.32	59.11	1,305.13
Effect of Common control transactions on Net Assets Acquired	E	-	-	3.24	3.24
Net Assets Considered	F = D + E	812.70	433.32	62.35	1,308.37
Final Dividend	G				(2.39)
Tax on dividend	H				(0.49)
Purchase Consideration	I	62.32	35.94	5.74	104.00
Capital Reserve	J = (F+G+H-I)	750.38	397.38	56.61	1,201.49

**50 Business Combination**

Autamark Motors Private Limited, a subsidiary company has acquired the business carried out under the dealership Volkswagen of "Navjivan Auto Square Private Limited" w.e.f June 6, 2021 at a purchase consideration of Rs. 36.32 millions. Value of net assets acquired is determined at Rs. 33.98 million, consequently goodwill amounting to Rs. 2.34 millions has been recognized in accordance with Ind AS 103 – "Business Combination". Navjivan Auto Square Private Limited was engaged in the business of sales and services of automobiles of a single brand "Volkswagen".

Based on the fair value of the assets acquired, purchase price paid has been allocated among various assets as below:

Particulars	Amount
<b>Assets:</b>	
Property, Plant and Equipment	11.55
Customer relationship	15.00
Other Assets	10.21
<b>Total Assets Acquired (A)</b>	<b>36.76</b>
<b>Liabilities:</b>	
Unserviced Annual Maintenance Contracts	2.78
<b>Total Liabilities assumed (B)</b>	<b>2.78</b>
<b>Net Assets Acquired (C = A - B)</b>	<b>33.98</b>
<b>Purchase Consideration (D)</b>	<b>36.32</b>
<b>Goodwill arising on business combination (E = D - C)</b>	<b>2.34</b>

**Landmark Cars Limited (formerly known as Landmark Cars Private Limited)**  
**Notes to the Restated Consolidated Financial Information**  
**(All amount in INR Millions unless otherwise stated)**

**51 Utilisation of the borrowed funds**

The Group has granted loans to the following entities for the business purpose as detailed below:

**Period ended September 30, 2021**

Loan given by	Intermediary Company	Reporting Quarter	Frequency of transaction	Aggregate of Amount	Name of Ultimate Beneficiary
Landmark Automobiles Private Limited	Ascendancy Financial Services Private Limited	April - June 2021	4	30.00	Automark Motors Private Limited
Landmark Automobiles Private Limited		July - September 2021	1	40.00	Landmark Cars Limited

**Year ended March 31, 2021**

Loan given by	Intermediary Company	Reporting Quarter	Frequency of transaction	Aggregate of Amount	Name of Ultimate Beneficiary
Automark Motors Private Limited	Ascendancy Financial Services Private Limited	April - June 2020	1	10	Benchmark Motors Private Limited
		April - June 2020	1	15	Landmark Lifestyle Cars Private Limited
January - March 2021		4	30	Benchmark Motors Private Limited	
January - March 2021		15	90	Landmark Commercial Vehicles Private Limited	
January - March 2021		7	35	Landmark Lifestyle Cars Private Limited	
October - December 2020		1	13	Landmark Lifestyle Cars Private Limited	
Landmark Automobiles Private Limited					

**Year ended March 31, 2020**

Loan given by	Intermediary Company	Reporting Quarter	Frequency of transaction	Aggregate of Amount	Name of Ultimate Beneficiary
Automark Motors Private Limited	Ascendancy Financial Services Private Limited	April - June 2019	5	30.00	Benchmark Motors Private Limited
		July - September 2019	3	13.00	
		January - March 2020	5	43.07	
		July - September 2019	2	5.00	Landmark Commercial Vehicles Private Limited
		October - December 2019	1	20.00	
		January - March 2020	2	15.50	
		July - September 2019	3	11.00	Landmark Lifestyle Cars Private Limited
		October - December 2019	7	59.40	
		January - March 2020	13	116.30	
		July - September 2019	1	2.00	Benchmark Motors Private Limited
Landmark Automobiles Private Limited		October - December 2019	3	18.50	
		January - March 2020	1	50.00	
		April - June 2018	1	5.00	Landmark Commercial Vehicles Private Limited
		April - June 2018	2	40.00	Landmark Lifestyle Cars Private Limited
Landmark Cars Limited		April - June 2018	1	20.00	Watermark Cars Private Limited
		October - December 2019	1	30.00	Landmark Commercial Vehicles Private Limited

**Year ended March 31, 2019**

Loan given by	Intermediary Company	Reporting Quarter	Frequency of transaction	Aggregate of Amount	Name of Ultimate Beneficiary
Automark Motors Private Limited	Ascendancy Financial Services Private Limited	October - December 2018	2	10.00	Benchmark Motors Private Limited
		January - March 2019	3	5.00	
Landmark Automobiles Private Limited		April - June 2018	1	13.00	Landmark Lifestyle Cars Private Limited
		January - March 2019	1	11.50	
		April - June 2018	9	92.00	Watermark Cars Private Limited
		April - June 2018	1	5.00	
		July - September 2018	2	3.00	
		October - December 2018	4	31.00	
		January - March 2019	2	10.00	

Landmark Cars Limited (formerly known as Landmark Cars Private Limited)  
Notes to the Restated Consolidated Financial Information  
(All amount in INR Millions unless otherwise stated)

52 Ratio Analysis and its elements

Ratio	September 30, 2021	March 31, 2021	March 31, 2020	March 31, 2019	% change from March 31, 2021 to September 30, 2021 *	% change from March 31, 2020 to March 31, 2021	% change from March 31, 2019 to March 31, 2020
Current Ratio	0.97	0.96	0.83	0.91	NA	16.36%	(9.74)%
Debt-Equity Ratio	1.95	1.80	2.11	2.53	NA	(14.77)%	(16.87)%
Debt Service Coverage Ratio <sup>(1)</sup>	3.63	6.29	3.35	4.05	NA	87.64%	(17.10)%
Return on Equity Ratio <sup>(2)</sup>	13.35%	6.11%	-17.03%	-12.93%	NA	(135.89)%	31.75%
Inventory turnover ratio	3.86	6.40	6.70	7.41	NA	(4.45)%	(9.59)%
Trade Receivables turnover ratio	22.43	49.25	43.51	40.49	NA	13.21%	7.45%
Trade payables turnover ratio	12.40	21.94	28.28	37.66	NA	(22.42)%	(24.89)%
Net capital turnover ratio	6.75	10.73	13.06	14.96	NA	(17.86)%	(12.71)%
Net profit ratio <sup>(3)</sup>	1.98%	0.57%	(1.30)%	(0.86)%	NA	(143.69)%	50.93%
Return on Capital employed <sup>(4)</sup>	6.51%	8.59%	1.07%	3.19%	NA	702.72%	(66.48)%
Return on investment <sup>(5)</sup>	13.32%	6.23%	(16.99)%	(13.44)%	NA	(136.69)%	26.44%

\* Considered as not applicable since constituting amounts for the six months ended September 30, 2021 has not been annualized.

**Reasons for variance of more than 25% in above ratios :**

<sup>(1)</sup> : Debt Service Coverage Ratio has been increased to 1.88 times from March 31, 2020 to March 31, 2021 mainly due to increase in Earnings available for debt service by 2.13 times in comparison to March 2020.

<sup>(2)</sup> : Return on Equity Ratio declined from negative 12.93% to 17.03% in March 2020 mainly due to nationwide economic slowdown in the automobile sector resulted in reduction in earnings.

Return on equity has been strengthened from negative 17.03% to positive 6.11% in March 2021 mainly due to improvement in the margins alongwith effective cost management resulted in increase in earnings.

<sup>(3)</sup> : Net Profit Ratio declined from negative 0.86% to 1.30% in March 2020 mainly due to nationwide economic slowdown in the automobile sector resulted in reduction in earnings.

Net Profit Ratio has been strengthened from negative 1.30% to positive 0.57% in March 2021 mainly due to improvement in the margins alongwith effective cost management resulted in increase in earnings though revenue has been impacted due to COVID 19.

<sup>(4)</sup> : Return on Capital employed reduced from 3.19 % to 1.07% in March 2020 mainly due to nationwide economic slowdown in the automobile sector resulted in reduction in earnings.

Return on Capital employed enhanced from 1.07% to 8.59% in March 2021 mainly due to improvement in the margins alongwith effective cost management resulted in increase in earnings.

<sup>(5)</sup> : Return on Investment declined from negative 13.44% to 16.99% in March 2020 mainly due to nationwide economic slowdown in the automobile sector resulted in reduction in earnings.

Return on Investment has been strengthened from negative 16.99% to positive 6.23% in March 2021 mainly due to improvement in the margins alongwith effective cost management resulted in increase in earnings.

**Elements of Ratio**

Ratios	Numerator	Denominator	September 30, 2021		March 31, 2021		March 31, 2020		March 31, 2019	
			Numerator	Denominator	Numerator	Denominator	Numerator	Denominator	Numerator	Denominator
Current Ratio	<b>Current assets</b>	<b>Current liabilities</b>	6,176.55	6,398.38	5,242.67	5,458.11	3,961.66	4,799.38	5,834.96	6,380.12
Debt-Equity Ratio	<b>Debt</b> :- long term borrowings + short term borrowings + vehicle floor plan (Debt does not include lease liabilities)	<b>Equity</b> :- Total Equity	4,088.43	2,093.17	3,274.41	1,823.76	3,579.08	1,699.09	4,787.76	1,889.56
Debt Service Coverage Ratio	<b>Earning available for debt services</b> :- net profit before tax + non cash expenses (Depreciation and Amortisation excluding on amortisation of ROU) + interest expense on borrowings	<b>Interest + Installment</b> :- interest expenses on borrowings and current maturities	531.54	146.32	715.56	113.69	336.57	100.34	460.75	113.87
Return on Equity Ratio	Total Restated Profit /(loss) for the period / year	Total Equity	279.47	2,093.17	111.48	1,823.76	(289.39)	1,699.09	(244.28)	1,889.56
Inventory turnover ratio	<b>Cost of good sold</b> :- purchase of cars, spares and others + changes in inventories of stock-in-trade	Average Inventory	12,213.59	3,165.56	16,473.70	2,572.93	18,948.81	2,827.80	24,625.34	3,322.46
Trade Receivables turnover ratio	Revenue from operations	Average Trade Receivables	14,128.42	629.88	19,561.04	397.15	22,186.14	509.96	28,265.18	698.11
Trade payables turnover ratio	Total Purchase	Average Trade Payables	12,768.26	1,030.09	17,104.29	779.56	17,808.48	629.67	24,776.35	657.96
Net capital turnover ratio	Revenue from operations	Total equity (parent + non controlling interest)	14,128.42	2,093.17	19,561.04	1,823.76	22,186.14	1,699.09	28,265.18	1,889.56
Net profit ratio	Restated profit / (loss) after tax	Revenue from operations	279.47	14,128.42	111.48	19,561.04	(289.39)	22,186.14	(244.28)	28,265.18
Return on Capital employed	<b>Earning before interest &amp; taxes (EBIT)</b> :- restated profit/(loss) before tax + interest expenses on financial liabilities carried at amortised cost	<b>Capital Employed</b> : - total equity (parent + non controlling interest) + borrowings + vehicle floor plan	402.72	6,181.60	438.15	5,098.17	56.51	5,278.17	213.26	6,677.32
Return on investment	Restated profit / (loss) after tax attributable to owners of the company	Equity shareholders' fund	277.80	2,085.49	113.31	1,817.75	(287.31)	1,691.25	(252.55)	1,879.64

**Landmark Cars Limited (formerly known as Landmark Cars Private Limited)**  
**Notes to the Restated Consolidated Financial Information**  
**(All amount in INR Millions unless otherwise stated)**

- 53 The Restated Consolidated Financial Information were authorized for issue in accordance with a resolution of the directors on January 17, 2022.

**For and on behalf of the Board of Directors**

**Sanjay Thakker**

Director  
DIN No. 00156093  
Place: Mumbai  
Date: January 17, 2022

**Paras Somani**

Director  
DIN No. 02742256  
Place: Ahmedabad  
Date: January 17, 2022

**Surendra Agarwal**

Chief Financial Officer  
Place: Mumbai  
Date: January 17, 2022

**Amol Raje**

Company Secretary  
Membership No: A19459  
Place: Mumbai  
Date: January 17, 2022

## OTHER FINANCIAL INFORMATION

### Accounting ratios

The accounting ratios derived from Restated Consolidated Financial Information required to be disclosed under the SEBI ICDR Regulations are set forth below:

Particulars	As at and for the six-months ended September 30, 2021	As at/for the Fiscals ended March 31,		
		2021	2020	2019
Basic Earnings / (loss) per Equity Share (in ₹)	7.58*	3.09	(7.84)	(7.01)
Diluted Earnings / (loss) per Equity Share (in ₹)	7.40*	3.05	(7.84)	(7.00)
Return on net worth (in %)	13.32%*	6.23%	(16.99%)	(13.44%)
Net asset value per Equity Share (in ₹)	56.93	49.62	46.17	52.14
EBITDA (₹ in million)	776.52	1,200.63	831.95	886.27

\*Not annualised

Notes:

(1) The ratios on the basis of Restated Consolidated Financial Information have been computed as below:

Basic Earnings per share (₹)	:	<u>Restated Net profit/(loss) after tax for the year / period attributable to equity shareholders of the Company</u> <u>Weighted average number of Equity Shares outstanding during the year/period post sub-division</u>
Diluted Earnings per share (₹)	:	<u>Restated Net profit/(loss) after tax for the year / period attributable to equity shareholders of the Company</u> <u>Weighted average number of Equity Shares outstanding during the year/period adjusted for the effects of all dilutive potential Equity shares post sub-division</u>
Return on Net Worth (%)	:	<u>Restated net profit/(loss) after tax for the year / period attributable to equity shareholders of the Company</u> <u>Restated Total equity attributable to equity owners of the Parent</u>
Net asset value per Equity Share	:	<u>Restated Total equity attributable to equity holders of the Parent.</u> <u>Weighted Average Number of equity shares outstanding during the year/ period post sub-division</u>
Net Assets	:	<u>Total Assets less total liabilities less minority interest</u>
EBITDA	:	<u>Restated profit/(loss) for the respective year/period + total tax expenses + finance costs + depreciation and amortisation</u>

### Other financial statements

In accordance with the SEBI ICDR Regulations, the audited standalone financial statements of our Company and our Material Subsidiaries, AMPL, BMPL, LAPL, LCVPL, and LLCPL for Fiscals 2021, 2020 and 2019 (collectively, the “**Audited Financial Statements**”) are available on our website at <https://www.grouplandmark.in/corporate-document/>.

Our Company is providing a link to this website solely to comply with the requirements specified in the SEBI ICDR Regulations. The Audited Financial Statements do not constitute, (i) a part of this Draft Red Herring Prospectus; or (ii) a prospectus, a statement in lieu of a prospectus, an offering circular, an offering memorandum, an advertisement, an offer or a solicitation of any offer or an offer document to purchase or sell any securities under the Companies Act, the SEBI ICDR Regulations, or any other applicable law in India or elsewhere. The Audited Financial Statements should not be considered as part of information that any investor should consider subscribing for or purchase any securities of our Company or any entity in which our Shareholders have significant influence (collectively, the “**Group**”) and should not be relied upon or used as a basis for any investment decision. None of the Group or any of its advisors, nor BRLMs or the Selling Shareholders, nor any of their respective employees, directors, affiliates, agents or representatives accept any liability whatsoever for any loss, direct or indirect, arising from any information presented or contained in the Audited Financial Statements, or the opinions expressed therein.

## CAPITALISATION STATEMENT

The following table sets forth our Company's capitalization as at September 30, 2021, on the basis of amounts derived from the Restated Consolidated Financial Information, and as adjusted for the Offer. This table should be read in conjunction with the sections "Management's Discussion and Analysis of Financial Position and Results of Operations", "Restated Consolidated Financial Information" and "Risk Factors" on pages 272, 202 and 28, respectively.

*(in ₹ million, except ratios)*

Particulars	Pre-Offer as at September 30, 2021	As adjusted for the Offer*
<b>Borrowings: **</b>		
Current borrowings	2,369.29	[●]
Vehicle Floor Plan payable	1,252.26	
Non-current borrowings	466.88	[●]
<b>Total borrowings (A)</b>	<b>4,088.43</b>	<b>[●]</b>
<b>Equity:</b>		
Equity Share capital***	183.13	[●]
Other equity	1,902.36	[●]
<b>Total equity attributable to equity holders of the Parent (B)</b>	<b>2,085.49</b>	<b>[●]</b>
<b>Total borrowings/ Total equity attributable to Equity holders of the Parent (A/B)^</b>	<b>1.96</b>	<b>[●]</b>
<b>Non-current borrowings / Total equity attributable to Equity holders of the Parent</b>	<b>0.22</b>	<b>[●]</b>

\*The corresponding post Offer capitalization data is not determinable at this stage pending the completion of the book building process and hence have not been furnished. To be updated upon finalization of the Offer Price.

\*\*\*Pursuant to a resolution of our Shareholders on November 10, 2021, each equity share of ₹10 each of our Company was sub-divided into two Equity Shares of ₹5 each. Accordingly, our issued and paid-up Equity Share capital of 18,312,810 equity shares of face value of ₹ 10 each was sub-divided into 36,625,620 Equity Shares of ₹5 each.

^ Debt to Equity Ratio = Borrowings/ Total Equity.



## **RELATED PARTY TRANSACTIONS**

For details of related party transactions as per the requirements under applicable accounting standards, i.e. *Ind AS 24 – Related Party Disclosures*, read with the SEBI ICDR Regulations, for the six months ended September 30, 2021 and for the years ended March 31, 2021, March 31, 2020 and March 31, 2019, see “*Restated Consolidated Financial Information – Note 44 - Related Party Transaction*” on page 251.

## MANAGEMENT'S DISCUSSION AND ANALYSIS OF FINANCIAL POSITION AND RESULTS OF OPERATIONS

*The following discussion of our financial condition and results of operations is based on, and should be read in conjunction with, our Restated Consolidated Financial Information (including the schedules, notes and significant accounting policies thereto), included in the section titled "Restated Consolidated Financial Information" beginning on page 202.*

*Our Restated Consolidated Financial Information have been derived from our audited consolidated financial statements and restated in accordance with the SEBI ICDR Regulations and the ICAI Guidance Note. Our financial statements are prepared in accordance with Ind AS, notified under the Companies (Indian Accounting Standards) Rules, 2015, and read with Section 133 of the Companies Act, 2013 to the extent applicable. Ind AS differs in certain material respects from IFRS and U.S. GAAP and other accounting principles with which prospective investors may be familiar. Accordingly, the degree to which the financial statements prepared in accordance with Ind AS included in this Draft Red Herring Prospectus will provide meaningful information is entirely dependent on the reader's level of familiarity with Ind AS accounting policies. We have not attempted to quantify the impact of IFRS or U.S. GAAP on the financial information included in this Draft Red Herring Prospectus, nor do we provide a reconciliation of our financial information to IFRS or U.S. GAAP. Any reliance by persons not familiar with Ind AS accounting policies on the financial disclosures presented in this Draft Red Herring Prospectus should accordingly be limited.*

*Unless otherwise indicated or the context requires otherwise, the financial information for the six-month period ended September 30, 2021, and for Fiscals 2021, 2020 and 2019 included herein have been derived from our restated consolidated balance sheets as of September 30, 2021, March 31, 2021, March 31, 2020 and March 31, 2019 and restated consolidated statements of profit and loss, cash flows and changes in equity for the six-month period ended September 30, 2021, and for the fiscal years ended March 31, 2021, March 31, 2020 and March 31, 2019 of the Company, together with the statement of significant accounting policies, and other explanatory information thereon.*

*Our fiscal year ends on March 31 of each year, and references to a particular fiscal period are to the 12 months ended March 31 of that year. All references to a year are to that Fiscal Year, unless otherwise noted. References to a six-month period or "Half Year" are to the six months ended September 30 of a particular fiscal year.*

*Some of the information contained in this section, including information with respect to our strategies, contain forward-looking statements that involve risks and uncertainties. You should read the section titled "Forward-Looking Statements" beginning on page 19 for a discussion of the risks and uncertainties related to those statements and also the section titled "Risk Factors" and "Our Business" beginning on pages 28 and 133, respectively, for a discussion of certain factors that may affect our business, results of operations and financial condition. The actual results of the Company may differ materially from those expressed in or implied by these forward-looking statements.*

*Unless otherwise stated, a reference to "the Company" or "our Company" is a reference to Landmark Cars Limited on a standalone basis, while any reference to "Group Landmark", "we", "us", and "our" refers to Landmark Cars Limited and its Subsidiaries on a consolidated basis.*

### Overview

We are a leading premium automotive retail business in India with dealerships for Mercedes-Benz, Honda, Jeep, Volkswagen and Renault (*Source: CRISIL Report, December 2021*). We also cater to the commercial vehicle retail business in India. We have a presence across the automotive retail value chain, including sales of new vehicles, after-sales services and repairs (including sales of spare parts, lubricants and accessories), sales of pre-owned passenger vehicles and facilitation of the sales of third-party financial and insurance products. We started our operations and opened our first dealership for Honda in CY1998, and we have expanded our network to include 112\* outlets in 8 Indian states, comprised of 61 sales showrooms and outlets and 51\* after-sales service and spares outlets, as of September 30, 2021. We are focused on the premium and luxury automotive segments. CRISIL Research expects overall passenger vehicles sales (mass market and premium market) to grow at a CAGR of 8-10% from Fiscal 2021 to Fiscal 2026 during the same period, while the luxury segment is expected to grow at a CAGR of 20-22%. (*Source: CRISIL Report, December 2021*). We were the number one dealer in India for Mercedes-Benz, Honda and Jeep in terms of wholesale sales for Fiscal 2021 and were the top contributor to Volkswagen retail sales for calendar year 2020. In addition, we were the third largest dealership in India for Renault, in terms of wholesale sales contribution for calendar year 2020. In Fiscal 2021, we contributed 13.41%, 5.20%, 21.63%, 5.95% and 4.83% of the domestic sales of Mercedes-Benz, Honda, Jeep, Volkswagen and Renault, respectively. (*Source: CRISIL Report, December 2021*). We also have a commercial vehicle dealership for Ashok Leyland.

*\*includes acquisition of 4 after sales service and spares outlets pursuant to acquisition of Shaman Wheels Private Limited w.e.f. October 1, 2021.*

## **Principal Factors Affecting our Results of Operations**

Our financial performance and results of operations are influenced by a variety of factors, some of which are beyond our control, including without limitation, general economic conditions, changes in costs of new and pre-owned automobiles and government regulations and policies. Some of the more important factors are discussed below, as well as in the section titled “*Risk Factors*” beginning on page 28.

### **COVID-19**

The outbreak of the COVID-19 pandemic, as well as GoI measures to reduce the spread of COVID-19, has had a material impact on our business and results of operations. Near the end of Fiscal 2020, the GoI initiated a nation-wide lockdown from March 24, 2020, which was initially set for three weeks, but was subsequently extended to May 31, 2020. Although the nationwide lockdown was lifted on June 1, 2020, restrictions on non-essential activities and travel were imposed until August 31, 2020, in multiple states across specific districts that were witnessing increases in COVID-19 cases. The second wave of COVID-19 infections impacted India in April, May and June 2021 and resulted in a significant strain on the health infrastructure in the country resulting in several states announcing lockdown measures. The second wave also resulted in a large part of the population working from home and implementing social distancing measures. In June 2021, the COVID-19 reported cases from the second wave declined and the GoI and state governments started gradually easing some of the strict precautionary measures.

According to CRISIL Research, India’s GDP contracted by 8.2% in Fiscal 2021 in large part due to the COVID-19-related restrictions imposed by the national and state governments. In view of the impact of the second wave of the COVID-19 pandemic, CRISIL Research expects that India’s GDP will grow by 9.5% for Fiscal 2022. (*Source: CRISIL Report, December 2021*).

As a premium and luxury automobile retail business, we experienced overall low demand for automobiles during the lockdowns and related COVID-19 restrictions on population movement, which resulted in reduced sales of automobiles and services. Restrictions on manpower movement during the lockdown also impacted our operations and expansion/improvement projects. We implemented health and safety measures for our employees. During Fiscal 2021, which covered the first wave of COVID-19 from April 2020 to June 2020, we incurred additional expenses toward obtaining COVID-19 health insurance coverage and purchasing oxygen concentrators for our employees. During the Half Year Fiscal 2022, which covered the second wave of COVID-19 from April 2021 to June 2021, the Company incurred additional expenses in connection with vaccination drives for our employees and their families. Further, we received COVID-19 support from certain OEMs in the form of incentives and interest benefits and an extension of automobile warranties.

In addition, we were affected to a certain extent by the worldwide logistics issues during the COVID-19 pandemic, as the supplies of automobiles were delayed. There is no assurance that logistics issues will not further worsen as the pandemic continues.

In response to the COVID-19-related lock-down restrictions, we accelerated our digital and online initiatives, which included the facilitation of sales enquiries and bookings through our websites (*i.e.*, Group Landmark’s umbrella website, as well as individual websites), social media platforms and also contacted customers through video conferencing means. We provide a platform for customers to enquire and book new cars through our Group Landmark umbrella website and have, since June 2021, started taking online bookings through the website.

The scope and nature of the impacts from COVID-19, most of which are beyond our control, continue to evolve, and the outcome is uncertain. While we have been able to manage our business to profitability with restated profit for the period/year of ₹279.47 million and ₹111.48 million for the six months ended September 30, 2021 and Fiscal 2021, respectively, as compared to a restated loss for the year of ₹(289.39) million and ₹(244.28) million for Fiscal 2020 and Fiscal 2019, respectively, we cannot assure you that the pandemic will not impose any adverse impact on our business operations or financial condition in the future. The ultimate extent of the effects of the COVID-19 pandemic on us, and the end markets we serve, is highly uncertain and will depend on future developments and such effects could exist for an extended period even after the pandemic ends. To the extent the COVID-19 pandemic does adversely affect our business, financial condition or results of operations, it may also have the effect of heightening many of the factors listed in the section “*Risk Factors*” beginning on page 28.

### ***Demand for automobiles***

Demand for automobiles is a key driver affecting our revenue and profitability, as we derive a significant portion of our revenue from sales of premium and luxury automobiles to consumers in India. According to CRISIL Research, the mass and premium segments of the Indian passenger vehicle (PV) industry grew (in terms of sales volume) by a CAGR of 6.6% between Fiscal 2016 and Fiscal 2019, primarily due to an increase in demand driven by improved economics, higher affordability and launches of new automobile models. The mass and premium PV segments are expected to grow (in terms of sales volume) by a CAGR of 8-10% from approximately 2.7 million units in Fiscal 2021 to an estimated 4.2 million units in Fiscal 2026. Similarly, the luxury segment of the Indian PV industry grew (in terms of sales volume) by a CAGR of 9% between Fiscal 2016 and Fiscal 2019, and is expected to grow (in terms of sales volume) by a CAGR of 17-19% from 163,000 units in Fiscal 2021 to an estimated 370,000 to 390,000 units by Fiscal 2026. (Source: CRISIL Report, December 2021).

The development of the premium and luxury automobile market in India will depend on a number of factors, some of which are beyond our control. Such external factors include the general economic conditions in India, the introduction of new models, financing conditions and their impact on consumer spending with respect to premium and luxury automobiles. General economic factors can significantly affect demand for automobiles, and therefore can affect demand for our products, including, among others:

- global oil prices, which impact the demand for automotive and non-automotive components;
- global and local economic or fiscal instability;
- global and local political and regulatory measures and developments, such as tax incentives or other subsidies, environmental policies, the phasing out of older vehicles or other developing trends, such as the move towards electrification and emissions reduction;
- global and local fiscal and monetary dynamics, such as rises or falls in interest rates (resulting in greater or lesser ability by customers to borrow money, including for automotive purchases), foreign exchange rates and inflation rates;
- general levels of GDP growth and growth in personal disposable income in the country or particular regions of the country;
- demographic conditions and population dynamics, such as the absolute size of a market and the growth rates of the population in that market; and
- economic development, shifting of wealth in India, in particular growth in the middle class, and change in customer preferences in favour of more fuel efficient and environmentally friendly vehicles.

Stronger economic indicators tend to correlate with higher demand for premium and luxury automobiles, while weaker economic indicators tend to correlate with lower demand for such automobiles. The cyclical nature of general economic conditions and, therefore, of the automobile market means that our results of operations can fluctuate substantially from period to period. We expect that these economic factors and conditions in our industry, particularly changes in consumer confidence, employment levels, fuel prices, consumer spending on premium and luxury automobiles, changes in consumer preferences, government policies and interest rates, will continue to be the most important factors affecting our results of operations.

In addition to external factors, our own strategies and the degree to which we are able to successfully implement our strategies influence demand for our offerings. In particular, our ability to constantly source a sufficient quantity and variety of desirable automobiles, the prices we can offer, our delivery times and our ability to successfully market our vehicles, as well as the additional services and customer service we can offer, drive demand for our automobile offerings and, therefore, have an effect on our market share and our ability to win customers in competitive situations.

### ***Sourcing of automobiles***

Our continued growth depends on our ability to source sufficient quantities and varieties of in-demand new automobiles. In terms of new models, we currently offer Mercedes-Benz, Honda, Jeep, Volkswagen and Renault passenger vehicles and Ashok Leyland commercial vehicles. Except for Mercedes-Benz, which has recently converted into an agency model, we have entered into dealership agreements with each of the OEMs, pursuant to which we purchase vehicles directly from such OEMs and resell them to customers. Effective as of October 1, 2021, we have entered into agency agreements with Mercedes-Benz pursuant to which we are an authorized agent of Mercedes-Benz, on a non-exclusive basis, in Gujarat, Maharashtra, Madhya Pradesh and West Bengal. Under the agency model, we act as an agent for Mercedes-Benz; customers place orders through us to Mercedes-Benz on we earn a commission on each sale. In the event that we are unable to source sufficient quantities of new vehicles from our OEMs for any reason, or if any of our OEMs terminates our dealership and agency agreements and we are unable to replace such OEM with an alternative source of comparable in-demand vehicles, our business, prospects, financial condition and results of operations could be materially and

adversely affected.

Our success will also depend on our and our OEMs' abilities to anticipate changing consumer preferences and tastes in new or updated automobile models. For instance, we currently anticipate that demand from Indian consumers for sport utility vehicles (or SUVs) will continue to increase for the foreseeable future. We intend to meet such expected demand by increasing our orders for SUVs through our OEMs. SUVs generally carry a higher margin, so any increase in sales of SUVs should increase our profitability. In addition, given the global automotive industry's trend toward increasing adoption of electric passenger vehicles (EVs), we expect an increase in demand for EVs among Indian consumers, particularly as the necessary infrastructure to support EV adoption continues to build out and the technology matures. Accordingly, our subsidiary, WCPL, has entered into a letter of intent dated November 30, 2021 with the automaker BYD to be their dealer in the National Capital Region (Delhi) and Mumbai in respect of their electric passenger vehicles. We also understand that several of our OEMs have announced plans for new SUV and EV models in the near future. In the event that we are unable to anticipate consumer preferences and tastes accurately or our OEMs produce automobile models that are not accepted by consumers, we may lose market share and our business and results of operations could be adversely affected.

### ***Improving Profitability Through Growth of Vertically Integrated Business Lines***

The Indian automotive industry has experienced a number of difficulties over the past few years, including as a result of the GoI's demonetization policies and the imposition of GST with effect from July 1, 2017 and the impacts of the first and second waves of the COVID-19 pandemic on consumer activity in Fiscal 2021 and the first six months of Fiscal 2022. Despite such difficulties, we have actively worked to improve our profitability through a number of strategies to cater to the entire customer value chain and take advantage of economies of our growing scale, including expanding our after-sales service offerings, which provide higher-margin service and repair revenues and a more consistent revenue stream throughout a fiscal year, and distributing third-party financial and insurance products.

The service segment is a high-margin segment for a dealership and contributes a sizeable amount to overall automobile dealership profitability, according to CRISIL Research. (*Source: CRISIL Report, December 2021*). We operate as authorized service centers for Mercedes-Benz, Honda, Volkswagen, Jeep, Renault and Ashok Leyland, and we provide after-sales service and repairs through our 51\* after-sales service and spares outlets across eight Indian states. We also sell spare parts, lubricants, accessories and other products from these outlets. Our after-sales service and spare parts business provides a more consistent revenue stream and contributes to higher-margin revenues at each of our dealerships, which helps mitigate the cyclical nature that has historically impacted some elements of the automotive sector. Our after-sales service and spare parts revenue contributed to 17.20%, 21.62%, 21.66% and 16.28% of our total revenue from operations, respectively, and our after-sales service and spare parts EBITDA contributed to 59.31%, 64.23%, 104.07% and 90.82% of our EBITDA during the six months ended September 30, 2021 and Fiscal 2021, Fiscal 2020 and Fiscal 2019, respectively. In the six months ended September 30, 2021 and Fiscal 2021, Fiscal 2020 and Fiscal 2019, our EBITDA Margins from our after-sales service and spare parts business were 18.47%, 17.75%, 17.91% and 17.34%, respectively.

\*includes acquisition of 4 after sales service and spares outlets pursuant to acquisition of Shaman Wheels Private Limited w.e.f. October 1, 2021.

As we continue to expand our after-sales service and spare parts business, we expect to invest in service stations, including by acquisition of existing dealerships from other dealers. Such investments will require upfront cash outlay while the build-up of car park of the relevant automobile brands (*i.e.*, cars sold in previous years and being operated by customers in the relevant geography) will take time to grow. The costs for operating service stations are largely fixed. As the car park of our automobile brands grows, we would expect that revenues and utilization of our service stations will grow with a improving margins and ROCE.

In addition, we are training our sales consultants and service technicians to improve their productivity with an aim to increase sales of vehicles and finance and insurance products and grow our after-sales service volume.

Our ability to improve our profitability through expanding our after-sales service and spare parts business and the distribution of third-party financial and insurance products will depend on our ability to anticipate customer demand and preferences, among other factors.

### ***Cost of Funding***

We require substantial working capital for our business. The costs of the vehicles we purchase, including purchase and transport costs, are recorded under our purchase of cars, spares and others line item on our statement of profit and loss, and represents the largest share of our operating expenses. During the six months ended September 30, 2021, Fiscal 2021,

Fiscal 2020 and Fiscal 2019, our purchase of cars, spares and others amounted to ₹12,768.26 million, ₹17,104.29 million, ₹17,808.48 million and ₹24,776.35 million, respectively, which represented 89.93%, 86.99%, 79.90% and 87.41% of our total income for the respective periods. Under the terms of our dealership agreements with the OEMs, we are required to make the funds available in our inventory funding accounts with banks/financial institutions with whom we have made arrangements for finance and the OEM will obtain the money from the inventory funding before cars, spare parts and accessories are released from their factory. Therefore, we are required to fund a significant portion of our purchase costs for automobiles before we can sell the vehicles. We have arranged for financing with banks/financial institutions, which allows us to finance up to 100% of our inventory. The average interest rate we paid for our borrowings in the six months ended September 30, 2021, Fiscal 2021, Fiscal 2020 and Fiscal 2019 was 6.49%, 7.01%, 7.24% and 8.87%, respectively. As collateral for this debt financing, we pledge our inventory and buildings. By financing our inventory at attractive interest rates, we limit the cash requirements for our continued expansion.

In addition, we require a certain amount of capital expenditure to maintain, expand and upgrade our existing facilities. As of September 30, 2021, we are operating at 112\* outlets in 8 Indian states, comprised of 61 sales showrooms and outlets and 51\* after-sales service and spares outlets. In the six months ended September 30, 2021, Fiscal 2021, Fiscal 2020 and Fiscal 2019, we incurred capital expenditure (comprising of payments for acquisition of property, plant and equipment, intangible assets and capital work in progress including capital advances and capital creditors) of ₹246.58 million, ₹148.03 million, ₹224.13 million and ₹359.23 million, respectively. A significant amount of our capital expenditure was aimed at the purchase of our owned workshop premises at Mercedes, Kolkata and the asset purchase of new dealerships.

\*includes acquisition of 4 after sales service and spares outlets pursuant to acquisition of Shaman Wheels Private Limited w.e.f. October 1, 2021.

The actual amount and timing of our future capital requirements may differ from estimates as a result of, among other things, unforeseen delays or cost overruns in our expansion projects, changes in business plans due to prevailing economic conditions, unanticipated expenses and regulatory changes. To the extent our planned expenditure requirements exceed our available resources, we will be required to seek additional debt or equity financing. Additional debt financing could increase our interest costs and require us to comply with additional restrictive covenants in our financing agreements. Additional equity financing could dilute our earnings per Equity Share and your interest in the Company and could adversely impact our Equity Share price.

### ***Change to Agency Model for Mercedes-Benz***

With effect from October 1, 2021, our dealership agreement with Mercedes-Benz materially changed and converted to an agency model whereby all car sales are now made directly to customers by Mercedes-Benz. Under this agency model, customers now place orders through us directly to Mercedes-Benz; we earn a commission on each sale of Mercedes-Benz made through us. This change to an agency model will significantly reduce working capital requirements from October 1, 2021 since we no longer purchase cars from Mercedes-Benz and are no longer required to carry an inventory of Mercedes-Benz cars, except for demo cars. In statement of profit and loss, this change will have the effect of (i) reducing our expenses (namely, a reduction in our purchases of cars and changes in inventories of stock-in-trade, and in interest expenses due to decreased working capital financing requirements and other sales-related expenses), (ii) reducing sale of cars revenue from Mercedes-Benz cars, as we will no longer book the full sales price of vehicles sold as revenue, and (iii) increasing sale of services, as commissions earned on each Mercedes-Benz vehicle sale will be recorded in the statement of profit and loss as sale of services. In statement of assets and liabilities, this change will have the effect of reducing our trade receivables, vehicle floor plan, GST credit receivable and payable, advances from customers and inventories.

### ***Competition***

Although the automobile retail industry has relatively high barriers to entry due to, among other factors, high capital requirements and stringent dealer selection criteria of automobile OEMs, we nevertheless operate in a highly competitive industry. We compete with other dealers of Mercedes-Benz, Honda, Jeep, Volkswagen and Renault in passenger vehicles and with other dealers of Ashok Leyland in commercial vehicles. In addition, we face competition from distributors and dealers of other brands of automobiles and re-sellers of pre-owned passenger vehicles, including competition from companies that operate numerous automotive retail stores on a regional or national basis and online and mobile sales platforms. In the premium and luxury segments of the automobile market, direct competing brands include BMW, Audi, Lexus, Porsche, Land Rover, Jaguar and Tesla. Some of our competitors may also have greater financial and technological resources and may also have larger sales and marketing teams. Any inability on our part to remain competitive in our markets will adversely affect our financial condition and results of operation.

### ***Improving operational efficiency***

In order to improve our operational efficiency and profitability, we have taken various measures to take advantage of the inherent synergies arising from our complementary business verticals by reducing our costs where possible, including rental expenses for showrooms and service centres taken on lease and optimization of administrative, sales, marketing and travel costs. Such measures have resulted in a reduction in (i) rent expense by 22.40%, (ii) employee benefits expense by 21.26%, (iii) marketing costs by 48.50%, and (iv) travel costs by 46.79%, in Fiscal 2021 as compared to Fiscal 2020.

In terms of our rent expense, we have been able to optimize the lease costs by successfully utilizing the showroom space for two brands and using the same workshop for servicing vehicles of two brands. We expect this to help increase revenue per sq. ft for showrooms and optimize capacity utilization of service stations by reducing downtime/idle time. In the six months ended September 30, 2021, Fiscal 2021, Fiscal 2020 and Fiscal 2019, our rent expense (excluding the impact of Ind AS 116) represented 1.86%, 2.02%, 2.29% and 1.77% of our total income, respectively.

Employee benefits expense comprise our second largest expense after purchase of cars, spares and others. In the six months ended September 30, 2021, Fiscal 2021, Fiscal 2020 and Fiscal 2019, our employee benefit expenses represented 4.75%, 5.48%, 6.13% and 5.37% of our total income, respectively. As a material portion of our overall manpower is located in India, rising wages in India as well as any change in applicable labour laws, would increase our costs.

Our marketing activities are aimed at driving the maximum relevant traffic to our showrooms and enhancing the recognition of our already well-established retail and merchant brands. We consider these activities a key component of our operations. While we expect our marketing expenses to increase on an absolute basis as we continue efforts to drive the expansion of our retail sales, including through our online initiatives, we do expect to continue to benefit from certain economies of scale in respect of our marketing spend. For the six months ended September 30, 2021, Fiscal 2021, Fiscal 2020 and Fiscal 2019, our marketing expenses represented 0.41%, 0.50%, 0.86% and 0.88% of our total income, respectively.

With an aim to strengthen our balance sheet, we were able to reduce our borrowings by ₹1,513.35 million from March 31, 2019 to March 31, 2021, by reducing our inventory levels and paying down our outstanding borrowings through internal accruals, resulting in a savings in finance costs of ₹149.58 million in Fiscal 2021 as compared to Fiscal 2019. In the six months ended September 30, 2021, Fiscal 2021, Fiscal 2020 and Fiscal 2019, our finance costs represented 1.28%, 1.92%, 2.01% and 1.86% of our total income, respectively.

### ***Seasonality***

Demand for automobiles in India tends to fluctuate between different periods within a fiscal year. Due to the Dusshera - Diwali festive season which falls in October / November as per the Panchanga / Hindu calendar and annual price increases instituted in January of each year, the October-December months tend to be the strongest sales period in any given fiscal year, while the remainder of the year is relatively average on sales performance. As sales of cars constitutes a majority of our revenue, this seasonality in demand influences our sales revenue and operating results within a single fiscal year. In addition, we generally receive more shipments ahead of the festive season, when there tends to be a spike in sales. As a result, our inventory tends to build up during this period. In addition, corporate purchases tend to be skewed towards the end of financial year when they can take the benefits of depreciation in their books. However, with the need for mobility across all social strata, we believe demand averages out across most quarters with spikes in the festive months of October/November.

### ***Significant Accounting Policies***

The Restated Consolidated Financial Information of the Group comprises of the Restated Consolidated Statement of Assets and Liabilities as at September 30, 2021, March 31, 2021, March 31, 2020 and March 31, 2019, the Restated Consolidated Statement of Profit and Loss (including Other Comprehensive Income), the Restated Consolidated Statement of Cash Flows and the Restated Consolidated Statement of Changes in Equity for the six months period ended September 30, 2021 and for the years ended March 31, 2021, March 31, 2020 and March 31, 2019 and the Summary of Significant Accounting Policies and explanatory notes (collectively, the “Restated Consolidated Financial Information”).

The Restated Consolidated Financial Information have been prepared by the Management of the Group for the purpose of inclusion in this Draft Red Herring Prospectus to be filed by the Company with the SEBI, NSE and BSE in connection with proposed Offer. The Restated Consolidated Financial Information, which have been approved by the Board of Directors of the Company, have been prepared in accordance with the requirements of:

- (a) Section 26 of Part I of Chapter III of the Companies Act, 2013, as amended ("the Act");
- (b) The Securities and Exchange Board of India (Issue of Capital and Disclosure Requirements) Regulations, 2018 ("ICDR") as amended from time to time; and
- (c) The Guidance Note on Reports in Company Prospectuses (Revised 2019) issued by the Institute of Chartered Accountants of India (ICAI) as amended (the "Guidance Note") read with the general directions dated October 28, 2021 received from Securities and Exchange Board of India (SEBI) by the Company through Lead Managers (the "SEBI Communication"), as applicable.

We have applied the following accounting policies in preparing our Restated Consolidated Financial Information:

### ***Key accounting estimates and judgements***

#### **Impairment of financial assets:**

The impairment provision for financial assets are based on assumptions about risk of default and expected loss rates. The Group uses judgement in making these assumptions and selecting the inputs to the impairment calculation, based on Group's past history, existing market conditions as well as forward looking estimates at the end of each reporting period.

#### **Taxation:**

Deferred tax, subject to the consideration of prudence, is recognised on temporary differences between the taxable income and accounting income that originate in one period and are capable of reversal in one or more subsequent periods. Deferred tax assets are recognised to the extent that there is reasonable certainty that sufficient future tax income will be available against which such deferred tax assets can be realized.

#### **Share based payment:**

Employees of the Group with a pre-defined grade is granted options to purchase equity shares. Each share option converts into one equity share of the Group on exercise. In accordance with the Ind AS 102 Share Based Payments, the cost of equity settled transactions is measured using the fair value method. The cumulative expense recognized for equity-settled transactions at each reporting date until the vesting date reflects the extent to which the vesting period has expired and the Group's best estimate of the number of equity instruments that will ultimately vest. The expense or credit recognized in the statement of profit and loss for a period represents the movement in cumulative expense recognized as at the beginning of the year and end of that period and is recognized in employee benefits expense.

#### **Fair Value Measurement:**

Fair value is the price that would be received to sell an asset or paid to transfer a liability in an orderly transaction between market participants at the measurement date. The Group's accounting policies require, measurement of certain financial / non-financial assets and liabilities at fair values (either on a recurring or non-recurring basis). Also, the fair values of financial instruments measured at amortised cost are required to be disclosed in the said Restated Consolidated Financial Information.

The Group is required to classify the fair valuation method of the financial / non-financial assets and liabilities, either measured or disclosed at fair value in the standalone financial statements, using a three level fair-value-hierarchy (which reflects the significance of inputs used in the measurement). Accordingly, the Group uses valuation techniques that are appropriate in the circumstances and for which sufficient data are available to measure fair value, maximizing the use of relevant observable inputs and minimizing the use of unobservable inputs.

The three levels of the fair-value-hierarchy are described below:

Level 1 – Quoted (unadjusted) market prices in active markets for identical assets or liabilities

Level 2 – Valuation techniques for which the lowest level input that is significant to the fair value measurement is directly or indirectly observable

Level 3 – Valuation techniques for which the lowest level input that is significant to the fair value measurement is unobservable



## **Revenue Recognition**

### **Revenue from operations**

Revenue from contracts with customers is recognized on transfer of control of promised goods or services to a customer at an amount that reflects the consideration to which the Group is expected to be entitled to in exchange for those goods or services.

Revenue towards satisfaction of a performance obligation is measured at the amount of transaction price (net of variable consideration) allocated to that performance obligation. The transaction price of goods sold and services rendered is net of variable consideration on account of various discounts and schemes offered by the Group as part of the contract.

This variable consideration is estimated based on the expected value of outflow. Revenue (net of variable consideration) is recognized only to the extent that it is highly probable that the amount will not be subject to significant reversal when uncertainty relating to its recognition is resolved.

### **Sale of products:**

Revenue from sale of products is recognized when the control on the goods have been transferred to the customer. The performance obligation in case of sale of product is satisfied at a point in time i.e., when the material is dispatched to the customer or on delivery to the customer, as may be specified in the contract.

### **Rendering of services:**

Revenue from services is recognized over time by measuring progress towards satisfaction of performance obligation for the services rendered. The Group uses output method for measurement of revenue from rendering of services based on time elapsed and / or parts delivered.

### **Revenue from other operating income**

The other operating revenue includes commission income and claims from suppliers. The performance obligation for other operating revenue is satisfied at point in time.

### **Other revenue**

Interest income is recognised using effective interest method. The effective interest rate is the rate that exactly discounts estimated future cash receipts through expected life of the financial asset to the gross carrying amount of the financial asset. When calculating the effective interest rate, the Group estimates the expected cash flows by considering all the contractual terms of the financial instrument but does not consider the expected credit losses.

All other incomes are recognised and accounted for on accrual basis.

### **Property, Plant and Equipment**

Property, Plant and Equipment are stated at cost, net of accumulated depreciation and accumulated impairment losses, if any.

The cost comprises the purchase price, borrowing cost if capitalization criteria are met and directly attributable cost of bringing the asset to its working condition for its intended use. Any trade discounts and rebates are deducted in arriving at the purchase price.

Subsequent expenditures relating to property, plant and equipment is capitalized only when it is probable that future economic benefits associated with these will flow to the Group and the cost of the item can be measured reliably.

All other expenses on existing property, plant and equipment, including day-to-day repair and maintenance expenditure and cost of replacing parts, are charged to the restated consolidated statement of profit and loss for the period during which such expenses are incurred.

Property, Plant and Equipment not ready for the intended use on the date of the restated consolidated statement of assets and liabilities are disclosed as "Capital work-in-progress".

Gains or losses arising from derecognition of fixed assets are measured as the difference between the net disposal proceeds and the carrying amount of the asset at the time of disposal and are recognized in the restated consolidated statement of profit and loss when the asset is derecognized.

Depreciation on Property, Plant and Equipment is calculated on the straight-line method as per the useful life prescribed in Schedule II to the Companies Act, 2013.

Leasehold improvements are amortized over the period of lease. Residual value of the leasehold improvements are considered as 5% of cost except in case of steel used as the Company and one of its subsidiary company is expected to receive residual value at 50% of cost at the end of its lease period.

In respect of Property, Plant and Equipment purchased during the year, depreciation is provided on a pro-rata basis from the date on which such asset is ready to use.

The residual value, useful live and method of depreciation of Property, Plant and Equipment are reviewed at each reporting period end and adjusted prospectively, if appropriate.

### **Intangible assets**

An intangible asset is recognised, only where it is probable that future economic benefits attributable to the asset will accrue to the enterprise and the cost can be measured reliably.

Intangible assets acquired separately are measured on initial recognition at cost. Intangible assets arising on acquisition of business are measured at fair value as at date of acquisition. Internally generated intangibles including research cost are not capitalized and the related expenditure is recognized in the restated consolidated statement of profit and loss in the period in which the expenditure is incurred. Following initial recognition, intangible assets are carried at cost less accumulated amortization and accumulated impairment loss, if any.

Intangible assets not ready for the intended use on the date of the restated consolidated statement of assets and liabilities are disclosed as intangible assets under development.

The useful lives of intangible assets are assessed as either finite or indefinite. Finite-life intangible assets are amortized on a straight-line basis over the period of their expected useful lives. Intangible assets acquired / purchased during the year are amortised on a pro-rata basis from the date on which such assets are ready to use.

Customer relationship acquired in business combination are amortised over a period of 5 years on straight line basis. Intangible assets with an indefinite useful life are not amortised. Such intangible assets are tested for impairment.

The residual value, useful live and method of amortization of intangible assets are reviewed at each reporting period end and adjusted prospectively, if appropriate.

### **Financial Instruments**

#### **Initial recognition**

The Group recognizes financial assets and financial liabilities when it becomes a party to the contractual provisions of the instrument.

All financial assets and liabilities are recognized at fair value on initial recognition.

Transaction costs that are directly attributable to the acquisition or issue of financial assets and financial liabilities that are not at fair value through profit or loss are added to or deducted from the fair value of financial assets or financial liabilities on initial recognition.

Transaction costs directly attributable to the acquisition of financial assets or financial liabilities at fair value through profit or loss are recognised immediately in Restated Consolidated Statement of Profit and Loss.

## **Subsequent measurement**

### **Non-derivative financial instruments**

#### **Financial assets carried at amortized cost**

A financial asset is subsequently measured at amortized cost if it is held within a business model whose objective is to hold the asset in order to collect contractual cash flows and the contractual terms of the financial asset give rise on specified dates to cash flows that are solely payments of principal and interest on the principal amount outstanding.

#### **Financial assets at fair value through other comprehensive income (FVTOCI)**

A financial asset is subsequently measured at fair value through other comprehensive income if it is held within a business model whose objective is achieved by both collecting contractual cash flows and selling financial assets and the contractual terms of the financial asset give rise on specified dates to cash flows that are solely payments of principal and interest on the principal amount outstanding.

The Group has made an irrevocable election for its investments which are classified as equity instruments to present the subsequent changes in fair value in other comprehensive income based on its business model. For such equity instruments, the subsequent changes in fair value are recognized in the restated other comprehensive income in the restated consolidated statement of profit and loss.

#### **Financial assets at fair value through profit or loss (FVTPL)**

A financial asset which is not classified in any of the above categories are subsequently measured at fair valued through profit or loss. Fair value changes are recognised as other income in the restated consolidated statement of profit or loss.

Based on the Group's business model, the Group has classified its Investment in Mutual Funds at FVTPL.

### **Derecognition of financial assets**

The Group derecognises a financial asset when the contractual rights to the cash flows from the financial asset expire, or it transfers the rights to receive the contractual cash flows in a transaction in which substantially all of the risks and rewards of ownership of the financial asset are transferred or in which the Group neither transfers nor retains substantially all of the risks and rewards of ownership and does not retain control of the financial asset.

On derecognition of a financial asset in its entirety, the difference between the asset's carrying amount and the sum of the consideration received and receivable and the cumulative gain or loss that had been recognised in other comprehensive income and accumulated in equity is recognised in the Restated Consolidated Statement of Profit and Loss if such gain or loss would have otherwise been recognised in the Restated Consolidated Statement of Profit and Loss on disposal of that financial asset.

#### **Financial liabilities at Fair Value through Profit or Loss (FVTPL)**

A financial liability may be designated as at FVTPL upon initial recognition if:

- such designation eliminates or significantly reduces a measurement or recognition inconsistency that would otherwise arise Expected to be realized or intended to be sold or consumed in normal operating cycle;
- The financial liability whose performance is evaluated on a fair value basis, in accordance with the Group's documented risk management;

Financial liabilities at FVTPL are stated at fair value, with any gains or losses arising on remeasurement recognised in the Statement of Profit and Loss. The net gain or loss recognised in profit or loss incorporates any interest paid on the financial liability.

#### **Financial liabilities at amortized cost**

Financial liabilities that are not held for trading and are not designated as at FVTPL are measured at amortised cost at the end of subsequent accounting periods. The carrying amounts of financial liabilities that are subsequently measured at

amortised cost are determined based on the effective interest method. Interest expense that is not capitalised as part of costs of an asset is included in the 'Finance costs' line item.

The effective interest method of calculating the amortised cost of a financial liability and of allocating interest expense over the relevant period.

The effective interest rate is the rate that exactly discounts estimated future cash payments (including all fees and points paid or received that form an integral part of the effective interest rate, transaction costs and other premiums or discounts) through the expected life of the financial liability, or (where appropriate) a shorter period, to the net carrying amount on initial recognition.

Trade and other payables are recognised at the transaction cost, which is its fair value, and subsequently measured at amortised cost.

### **Derecognition of Financial Liabilities**

The Group derecognises financial liabilities when, and only when, the Group's obligations are discharged, cancelled or have expired. An exchange with a lender of debt instruments with substantially different terms is accounted for as an extinguishment of the original financial liability and the recognition of a new financial liability. Similarly, a substantial modification of the terms of an existing financial liability is accounted for as an extinguishment of the original financial liability and the recognition of a new financial liability. The difference between the carrying amount of the financial liability derecognised and the consideration paid and payable is recognised in the Restated Consolidated Statement of Profit and Loss.

### **Off-setting of financial assets and financial liabilities**

Financial assets and liabilities are offset when the Group currently has a legally enforceable right to offset the recognised amount and intends either to settle on a net basis or to realize the asset and settle the liability simultaneously.

### **Modification**

A modification of a financial asset or liabilities occurs when the contractual terms governing the cash flows of a financial asset or liabilities are renegotiated or otherwise modified between initial recognition and maturity of the financial instruments. Any gain/ loss on modification is charged to restated consolidated statement of profit and loss.

### **Taxes**

Tax expense comprises current income tax and deferred tax.

### **Current Income Tax**

Current income tax assets and liabilities are measured at the amount expected to be recovered from or paid to the taxation authorities. Current income tax (including Minimum Alternate Tax ("MAT")) is measured at the amount expected to be paid to the tax authorities in accordance with the Income-Tax Act, 1961 enacted in India. The tax rates and tax laws used to compute the amount are those that are enacted or substantially enacted, at the reporting date.

Current income tax relating to items recognised outside the restated consolidated statement of profit and loss is recognised outside the restated consolidated statement of profit and loss (either in other comprehensive income or in equity). Current tax items are recognised in correlation to the underlying transaction either in OCI or directly in equity. Management periodically evaluates positions taken in the tax returns with respect to situations in which applicable tax regulations are subject to interpretation and establishes provisions where appropriate.

### **Deferred Tax**

Deferred tax is provided using the balance-sheet approach on temporary differences between the tax bases of assets and liabilities and their carrying amounts for financial reporting purposes at the reporting date.

Deferred tax liabilities are recognised for all taxable temporary differences, except to the extent that the deferred tax liability arises from initial recognition of goodwill; or an asset or liability in a transaction which is not a business combination and at the time of transaction, affects neither accounting profit nor taxable profit or loss.

Deferred tax assets are recognised for all deductible temporary differences, the carry forward of unused tax credits and any unused tax losses to the extent that it is probable that taxable profit will be available against which the deductible temporary differences and the carry forward of unused tax credits and unused tax losses can be utilized except when the deferred tax asset relating to the deductible temporary difference arises from the initial recognition of an asset or liability in a transaction that is not a business combination and at the time of the transaction, affects neither accounting profit nor taxable profit or loss.

The carrying amount of deferred tax assets is reviewed at each reporting date and reduced to the extent that it is no longer probable that sufficient future taxable profit will be available to allow all or part of the deferred tax asset to be utilised. Unrecognised deferred tax assets are re-assessed at each reporting date and are recognised to the extent that it has become probable that future taxable profits will allow the deferred tax asset to be recovered.

Deferred tax assets and liabilities are measured at the tax rates that are expected to apply to the period when the asset is realized or the liability is settled, based on the tax rates (and tax laws) that have been enacted or substantively enacted at the reporting date.

Deferred tax assets include Minimum Alternate Tax (MAT) credit paid in accordance with the tax laws in India, which is likely to give future economic benefits in the form of availability of set off against future income tax liability. Accordingly, MAT credit is recognized as deferred tax asset in the Balance sheet when the asset can be measured reliably and it is probable that the future economic benefit associated with the asset will be realised.

Deferred tax relating to items recognised outside the restated consolidated statement of profit and loss is recognised outside the restated consolidated statement of profit and loss (either in other comprehensive income or in equity). Deferred tax items are recognised in correlation to the underlying transaction either in OCI or directly in equity.

Deferred tax assets and deferred tax liabilities are offset, if a legally enforceable right exists to set off current tax assets against current tax liabilities and the deferred taxes relate to the same taxable entity and the same taxation authority.

## **Impairment**

### **Financial assets**

The Group recognizes loss allowances using the expected credit loss (ECL) model for the financial assets which are not fair valued through profit or loss.

Loss allowance for trade receivables with no significant financing component is measured at an amount equal to lifetime ECL.

For all other financial assets, expected credit losses are measured at an amount equal to the 12-month ECL, unless there has been a significant increase in credit risk from initial recognition in which case those are measured at lifetime ECL.

The impairment loss allowance (or reversal) recognised during the period is recognised as income / expense in the restated consolidated statement of profit and loss.

### **Non-financial assets**

#### **Tangible and intangible assets**

The Group assesses at each reporting date whether there is an indication that an asset may be impaired. If any indication exists, the Group estimates the asset's recoverable amount.

An asset's recoverable amount is the higher of an assets net selling price and its value in use. The recoverable amount is determined for an individual asset, unless the asset does not generate cash inflows that are largely independent of those from other assets or groups of assets.

Where the carrying amount of an asset exceeds its recoverable amount, the asset is considered impaired and is written down to its recoverable amount. The impairment loss is recognised in the restated consolidated statement of profit and loss.

In assessing value in use, the estimated future cash flows are discounted to their present value using a pre-tax discount rate that reflects current market assessments of the time value of money and the risks specific to the asset.

In determining net selling price, recent market transactions are taken into account, if available. If no such transactions can be identified, an appropriate valuation model is used.

## **Lease**

### **Group as lessee**

The Group's lease asset classes primarily consist of leases for showrooms, workshops and stockyards. The Group assesses whether a contract contains a lease, at inception of a contract. A contract is, or contains, a lease if the contract conveys the right to control the use of an identified asset for a period of time in exchange for consideration. To assess whether a contract conveys the right to control the use of an identified asset, the Group assesses whether: (i) the contract involves the use of an identified asset (ii) the Group has substantially all of the economic benefits from use of the asset through the period of the lease and (iii) the Group has the right to direct the use of the asset.

At the date of commencement of the lease, the Group recognizes a right-of-use (ROU) asset and a corresponding lease liability for all lease arrangements in which it is a lessee, except for leases with a term of 12 months or less (short-term leases) and low value leases. For these short-term and low-value leases, the Group recognizes the lease payments as an operating expense on a straight-line basis over the term of the lease.

The ROU assets are initially recognized at cost, which comprises the initial amount of the lease liability adjusted for any lease payments made at or prior to the commencement date of the lease plus any initial direct costs less any lease incentives. They are subsequently measured at cost less accumulated amortisation and impairment losses.

ROU assets are depreciated from the commencement date on a straight-line basis over the shorter of the lease term and useful life of the underlying asset.

The lease liability is initially measured at amortized cost at the present value of the future lease payments. The lease payments are discounted using the interest rate implicit in the lease or, if not readily determinable, using the incremental borrowing rates in the country of domicile of these leases.

Lease liability and ROU assets have been separately presented in the restated consolidated statement of assets and liabilities and lease payments have been classified as financing cash flows.

### **Borrowing costs**

Borrowing cost includes interest and other costs that Group has incurred in connection with the borrowing of funds.

Borrowing costs directly attributable to the acquisition, construction or production of an asset that necessarily takes a substantial period of time to get ready for its intended use or sale are capitalized as part of the cost of the respective asset.

All other borrowing costs are expensed in the year they occur.

Investment income earned on temporary investment of specific borrowing pending their expenditure on qualifying assets is deducted from the borrowing costs eligible for capitalization.

### **Employee Benefits**

#### **Defined Contribution Plan**

Retirement benefit in the form of provident fund, employees' state insurance fund scheme and Labour welfare scheme is a defined contribution scheme. The Company has no obligation, other than the contribution paid/payable under such schemes. The contribution paid/payable under the schemes is recognised during the period in which the employee renders the related service.

#### **Defined Benefit Plan**

The Group has provided the benefits of gratuity, a defined benefit plan (the "Gratuity Plan") covering eligible employees in accordance with the Payment of Gratuity Act, 1972. As per the Gratuity Plan, the Group makes monthly payment to their employees with remeasurement option to vested employees at retirement, death, incapacitation or termination of

employment, of an amount based on the respective employee's salary and the tenure of employment. The Group's liability is actuarially determined (using the Projected Unit Credit method) at the end of each year. Gratuity which is defined benefit plans is paid per month on the basis of employee's gross salary.

Remeasurements of the net defined benefit liability comprising actuarial gains and losses (excluding amounts included in net interest on the net defined benefit liability), are recognized in Other Comprehensive Income. Such remeasurements are not reclassified to the Restated Consolidated Statement of Profit and Loss in the subsequent periods.

Compensated absences are not to be carried forward beyond 12 months and are paid per month on the basis of the employee's gross salary.

### **Share based payments**

Employees (including senior executives) of the Group receive remuneration in the form of share-based payments, whereby employees render services as consideration for equity instruments (equity-settled transactions).

Equity-settled transactions. The cost of equity-settled transactions is determined by the fair value at the date when the grant is made using an appropriate valuation model.

That cost is recognised, together with a corresponding increase in share-based payment reserves in equity, over the period in which the service conditions are fulfilled in employee benefits expense. The cumulative expense recognised for equity-settled transactions at each reporting date until the vesting date reflects the extent to which the vesting period has expired and Group's best estimate of the number of equity instruments that will ultimately vest. The expense or credit in the restated consolidated statement of profit and loss for a period represents the movement in cumulative expense recognised as at the beginning and end of that period and is recognised in employee benefits expense.

No expense is recognised for awards that do not ultimately vest because service conditions have not been met. When the terms of an equity-settled award are modified, the minimum expense recognised is the grant date fair value of the unmodified award, provided the original vesting terms of the award are met. An additional expense, measured as at the date of modification, is recognised for any modification that increases the total fair value of the share-based payment transaction, or is otherwise beneficial to the employee. Where an award is cancelled by the entity or by the counterparty, any remaining element of the fair value of the award is expensed immediately through profit or loss.

The dilutive effect of outstanding options is reflected as additional share dilution in the computation of diluted earnings per share

### **Provisions, Contingent Liabilities and Contingent Assets**

Provisions are recognised when the Group has a present obligation (legal or constructive) as a result of a past event, it is probable that an outflow of resources embodying economic benefits will be required to settle the obligation and a reliable estimate can be made of the amount of the obligation. The expense relating to a provision is presented in the restated consolidated statement of profit and loss. Contingent liabilities are not recognised but disclosed unless the probability of an outflow of resources is remote. Contingent assets are disclosed where inflow of economic benefits is probable. If the effect of the time value of money is material, provisions are discounted using a current pre-tax rate that reflects, when appropriate, the risks specific to the liability. When discounting is used, the increase in the provision due to the passage of time is recognised as a finance costs.

### **Cash and cash equivalents**

Cash and cash equivalents in the restated consolidated statement of assets and liabilities comprise cash at banks and on hand and short-term deposits with an original maturity of three months or less, which are subject to an insignificant risk of changes in value.

For the purpose of the restated consolidated statement of cash flows, cash and cash equivalents consist of cash and short-term deposits, as defined above, net of outstanding bank overdrafts as they are considered an integral part of the Group's cash management.

### **Earnings per share**

Basic earnings per share is calculated by dividing the net profit or loss for the year/period attributable to equity shareholders of the Group by the weighted average number of equity shares outstanding during the year/period.

For the purpose of calculating diluted earnings per share, the net profit or loss for the year/period attributable to equity shareholders of the Group and the weighted average number of shares outstanding during the year/period are adjusted for the effects of all dilutive potential equity shares.

### **Inventories**

Inventories are valued at lower of cost and net realizable value. Cost is determined as follows:

- (i) In case of cars, at specific cost on identification basis of their individual costs.
- (ii) In case of spares and others, the same are valued at weighted average basis.

Costs includes all non-refundable duties and taxes and all other charges incurred in bringing the inventory to their present location and condition. Net realizable value is the estimated selling price less estimated cost necessary to make the sale.

### **Segment Reporting**

An operating segment is component of the Group that engages in the business activity from which the Group earns revenues and incurs expenses, for which discrete financial information is available and whose operating results are regularly reviewed by the chief operating decision maker (CODM), in deciding about resources to be allocated to the segment and assess its performance. The Group's chief operating decision maker is the Chairman of Parent Company.

Segment revenue, segment expenses, segment assets and segment liabilities have been identified to segments on the basis of their relationship to the operating activities of the segment. Inter segment revenue is accounted on the basis of transactions which are primarily determined based on market / fair value factors. Revenue, expenses, assets and liabilities which relate to the Group as a whole and are not allocable to segments on a reasonable basis have been included under "unallocated revenue / expenses / assets / liabilities".

### **Current versus non-current classification**

The Group presents assets and liabilities in the restated consolidated statement of assets and liabilities based on current / non-current classification.

An asset is treated as current when it is:

- Expected to be realized or intended to be sold or consumed in normal operating cycle;
- Held primarily for the purpose of trading;
- Expected to be realized within twelve months after the reporting period, or
- Cash or cash equivalent unless restricted from being exchanged or used to settle a liability for at least twelve months after the reporting period.

All other assets are classified as non-current.

A liability is current when:

- It is expected to be settled in normal operating cycle; or
- It is held primarily for the purpose of trading; or
- It is due to be settled within twelve months after the reporting period; or
- There is no unconditional right to defer the settlement of the liability for at least twelve months after the reporting period.

All other liabilities are classified as non-current.

Deferred tax assets and liabilities are classified as non-current assets and liabilities respectively.

The operating cycle is the time between the acquisition of assets for processing and their realisation in cash or cash equivalents. The Group has identified twelve months as its operating cycle.



## **Foreign currency transactions**

### **Initial recognition**

Transactions in foreign currencies entered into by the Group are accounted at the exchange rates prevailing on the date of the transaction or at rates that closely approximate the rate at the date of the transaction.

### **Measurement at the balance sheet date**

Foreign currency monetary items of the Group, outstanding at the balance sheet date are restated at the period-end rates. Non-monetary items of the Group are carried at historical cost.

### **Treatment of exchange differences**

Exchange differences arising on settlement / restatement of foreign currency monetary assets and liabilities of the Group are recognised as income or expense in the Consolidated Statement of Profit and Loss.

## **Business Combinations and Goodwill**

In respect of business combination after transition date, the Group accounts for all business combinations by applying the acquisition method. All acquisition-related costs are expensed unless disclosed otherwise and are in accordance with applicable accounting standards. On acquisition, the assets (including intangible assets), liabilities and contingent liabilities of an acquired entity are measured at their fair value. Non-controlling interest is stated at the non-controlling interest's proportion of the fair values of the assets and liabilities recognised.

Goodwill arising on consolidation represents the excess of the consideration transferred over the net fair value of the Group's share of the net assets, liabilities of the acquired subsidiary, joint venture or associate and the fair value of the non-controlling interest in the acquiree. If the consideration is less than the fair value of the Group's share of the net assets, liabilities of the acquired entity (i.e., gain on acquisition), the difference is credited to the capital reserve in the period of acquisition.

## **Cash Flow Statement**

Cash flows are reported using the indirect method, whereby loss for the period is adjusted for the effects of transactions of a non-cash nature, any deferrals or accruals of past or future operating cash receipts or payments and item of income or expenses associated with investing or financing cash flows. The cash flows from operating, investing and financing activities of the group are segregated.

## **Changes in the accounting policy, if any, in the last three years and their effect on our profits and reserves**

### ***First time adoption of Ind AS – mandatory exceptions and optional exemptions***

In accordance with the notification dated February 16, 2015, issued by Ministry of Corporate Affairs, the Company has voluntarily adopted Indian Accounting Standards notified under section 133 of the Companies Act, 2013 (the "Act") read with the Companies (Indian Accounting Standards) Rules, 2015, as amended ("Ind AS") with transition date from April 1, 2019.

Accordingly, the Restated Consolidated Financial Information have been compiled from:

- (a) The audited Special Purpose Consolidated Interim Financial Statements of the Group as at and for the six months period ended September 30, 2021 which is prepared in accordance with the recognition and measurement principles of Indian Accounting Standard 34 "Interim Financial Reporting" ("Ind AS 34") as prescribed under Section 133 of the Act read with relevant rules thereunder and other accounting principles generally accepted in India (the "Special Purpose Consolidated Interim Financial Statements"), which have been approved by the Board of Directors at their meeting held on January 17, 2022;
- (b) The audited Consolidated Ind AS financial statements of the Group as at and for the year ended March 31, 2021 along with comparative audited consolidated Ind AS financial statements for the year ended March 31, 2020 (the "Statutory Consolidated Ind AS Financial Statements") which have been approved by the Board of Directors at their meeting held on July 23, 2021. The comparative information as at and for the year ended March 31, 2020 included in such Consolidated Ind AS Financial Statements have been prepared by making Ind AS adjustments to the audited

consolidated Indian GAAP financial statements of the Group as at and for the year ended March 31, 2020, prepared in accordance with the accounting standards notified under the Section 133 of the Act (“Indian GAAP”) which was approved by the Board of directors at their meeting held on December 31, 2020;

- (c) The Company has prepared the Special Purpose Consolidated Ind AS Financial Statements as at and for the year ended March 31, 2019 (the “Special Purpose Consolidated Ind AS Financial Statements”) as per following basis, which have been approved by the Board of Directors at their meeting held on January 17, 2022.

In pursuance to the SEBI Communication, for the purpose of Special Purpose Consolidated Ind AS Financial Statements of the Group as at and for the year ended March 31, 2019, the transition date is considered as April 1, 2018, which is different from the transition date adopted by the Group at the time of first time transition to Ind AS (i.e., April 1, 2019) for the purpose of preparation of Statutory Consolidated Ind AS Financial Statements as required under Companies Act, 2013, as amended. Accordingly, the Group has applied the accounting policy choices (both mandatory exceptions and optional exemptions availed as per Ind AS 101) as on April 1, 2018 for these Special Purpose Consolidated Ind AS Financial Statements.

As such, the financial statements for the year ended March 31, 2019 are Special Purpose Consolidated Ind AS Financial Statements of the Group prepared considering the accounting principles stated in Ind AS, as adopted by the Group and described below. These Special Purpose Consolidated Ind AS Financial Statements have been prepared solely for the purpose of preparation of Restated Consolidated Financial Information for inclusion in this DRHP. As such, these Special Purpose Consolidated Ind AS Financial Statements are not suitable for any other purpose other than for the purpose of preparation of the Restated Consolidated Financial Information, and are also not financial statements prepared pursuant to any requirements under section 129 of the Companies Act, 2013, as amended. Further, since the statutory date of transition to Ind AS is April 1, 2019, and these Special Purpose Consolidated Ind AS Financial Statements have been prepared considering a transition date of April 1, 2018, the closing balances of items included in the Balance Sheet as at March 31, 2019 may be different from the balances considered on the statutory date of transition to Ind AS on April 1, 2019, due to such early application of Ind AS principles with effect from April 1, 2018 as compared to the date of statutory transition. Refer to Note 4 for reconciliation of equity and total comprehensive income as per the Special Purpose Consolidated Interim Financial Statements, Statutory Consolidated Ind AS Financial Statements, Statutory Indian GAAP Financial Statements (as defined below) and equity and total comprehensive income as per restated consolidated financial information.

The above Special Purpose Consolidated Ind AS Financial Statements have been prepared by making Ind AS adjustments as mentioned above to the audited consolidated Indian GAAP financial statements of the Group as at and for the year ended March 31, 2019 prepared in accordance with Indian GAAP (the “Statutory Indian GAAP Financial Statements”), which was approved by the Board of directors at their meeting held on September 30, 2019.

The Restated Consolidated Financial Information:

- (a) have been prepared after incorporating adjustments for the changes in accounting policies, material errors and regrouping/reclassifications retrospectively in the financial year ended March 31, 2021 and March 31, 2020 to reflect the same accounting treatment as per the accounting policies and grouping/classifications followed as at and for the six months period ended September 30, 2021;
- (b) do not require any adjustment for modification as there is no modification in the underlying audit reports;

These Restated Consolidated Financial Information do not reflect the effects of events that occurred subsequent to the respective dates of the board meetings for adoption of the Special Purpose Consolidated Interim Financial Statements, Statutory Consolidated Ind AS Financial Statements and the Statutory Indian GAAP Financial Statements.

These Restated Consolidated Financial Information have been prepared for the Group as a going concern basis.

The accounting policies have been consistently applied by the Company in preparation of the Restated Consolidated Financial Information and are consistent with those adopted in the preparation of financial statements for the six months period ended September 30, 2021.

*Exceptions Availed*

### Estimates

Our estimates in accordance with Ind AS as at the date of transition to Ind AS are consistent with the estimates made for the same date as per previous GAAP.

### Classification of financial assets

The classification of financial assets to be measured at amortised cost is made on the basis of the facts and circumstances that existed on the date of transition to Ind AS.

### *Exemptions Availed*

#### Deemed cost of property, plant and equipment and other intangible assets

We have elected to continue with the carrying value of all of its Property, Plant and Equipment and other intangible assets recognised as of date of transition measured as per the previous GAAP and use that carrying value as its deemed cost as of the transition date of Ind AS.

#### Business combinations

We have elected not to apply Ind AS 103 retrospectively to past business combinations that occurred before the date of transition to Ind AS. Therefore, the Group has not applied Ind AS 103 for business combinations that have occurred prior to the date of transition to Ind AS.

### Leases

Ind AS 116 requires an entity to assess whether a contract or arrangement contains a lease. According to Ind AS 116, this assessment should be carried out at the inception of the contract or arrangement. However, the Group has used Ind AS 101 exemption and assessed all arrangements based on conditions in place as the date of transition.

We have used the following transition exemptions in respect of lease transactions:

- (i) single discount rate has been applied to a portfolio of leases with reasonably similar characteristics;
- (ii) leases for which the lease term was ending within 12 months of the date of transition to Ind AS were accounted as short-term leases; and
- (iii) Initial direct costs have been excluded from the measurement of the right-of-use assets.

### **Key Performance Indicators and non-GAAP Financial Measures**

In addition to our results determined in accordance with Ind AS, we believe the following non-GAAP measures are useful to our Company and our investors as a means of assessing and evaluating our operating performance in comparison to prior periods: EBITDA, EBITDA Margin, Net Profit Ratio, Return on Equity Ratio, Return on Capital Employed, Net Debt / EBITDA Ratio, Net Worth, Return on Net Worth (RoNW) and NAV per Equity Share. We use the following non-GAAP financial information to evaluate our ongoing operations and for internal planning and forecasting purposes. We believe that non-GAAP financial information, when taken collectively with financial measures prepared in accordance with Ind AS, may be helpful to investors because it provides an additional tool for investors to use in evaluating our ongoing operating results and trends and in comparing our financial results with other companies in our industry because it provides consistency and comparability with past financial performance. However, our management does not consider these non-GAAP measures in isolation or as an alternative to financial measures determined in accordance with Ind AS.

Non-GAAP financial information is presented for supplemental informational purposes only, has limitations as an analytical tool and should not be considered in isolation or as a substitute for financial information presented in accordance with Ind AS. Non-GAAP financial information are not recognized under Ind AS and do not have standardized meanings prescribed by IND AS. In addition, non-GAAP financial measures used by us may differ from similarly titled non-GAAP measures used by other companies. The principal limitation of these non-GAAP financial measures is that they exclude significant expenses and income that are required by Ind AS to be recorded in our financial statements, as further detailed below. In addition, they are subject to inherent limitations as they reflect the exercise of judgment by management about which expenses and income are excluded or included in determining these non-GAAP financial measures. A reconciliation is provided below for each non-GAAP financial measure to the most directly comparable

financial measure prepared in accordance with Ind AS. Investors are encouraged to review the related Ind AS financial measures and the reconciliation of non-GAAP financial measures to their most directly comparable Ind AS financial measures included below and to not rely on any single financial measure to evaluate our business.

(₹ in millions, except for ratios and percentages)

Particulars	As at, or for the six months ended, September 30, 2021	As at, or for the fiscal year ended, March 31,		
		2021	2020	2019
EBITDA <sup>(1)</sup>	776.52	1,200.63	831.95	886.27
EBITDA Margin <sup>(2)</sup>	5.47%	6.11%	3.73%	3.13%
Net Profit Ratio <sup>(3)</sup>	1.98%	0.57%	(1.30)%	(0.86)%
Return on Equity Ratio <sup>(4)*</sup>	13.35%	6.11%	(17.03)%	(12.93)%
Return on Capital Employed <sup>(5)*</sup>	6.51%	8.59%	1.07%	3.19%
Net Debt / EBITDA Ratio <sup>(6)*</sup>	4.36	2.54	3.90	4.99
Net Worth <sup>(7)</sup>	2,085.49	1,817.75	1,691.25	1,879.64
Return on Net Worth (RoNW) <sup>(8)*</sup>	13.32%	6.23%	(16.99)%	(13.44)%
NAV per Equity Share <sup>(9)</sup>	56.93	49.62	46.17	52.14

Notes:

\* Amounts for the six months ended September 30, 2021 are not annualised.

- (1) EBITDA is calculated as the sum of (i) restated profit/(loss) for the period/year, (ii) total tax expense, (iii) finance costs, and (iv) depreciation and amortisation expenses.
- (2) EBITDA Margin is calculated as EBITDA divided by total income.
- (3) Net Profit Ratio is calculated as restated profit/(loss) for the period/year divided by revenue from operations.
- (4) Return on Equity Ratio is calculated as restated profit/(loss) for the period/year divided by total equity.
- (5) Return on Capital Employed is calculated as (i) EBIT, divided by (ii) Capital Employed. EBIT is calculated as the sum of (i) restated profit/(loss) before tax for the period/year, and (iii) interest expenses on financial liabilities carried at amortised cost. Capital Employed is calculated as the sum of non-current borrowings, current borrowings, vehicle floor plan, and total equity.
- (6) Net Debt / EBITDA Ratio is calculated as the (i) Net Debt, divided by (ii) EBITDA. Net Debt is calculated as (i) sum of non-current borrowings, current borrowings and vehicle floor plan, less (ii) sum of cash and cash equivalents and other balances with banks.
- (7) Net Worth is calculated as the sum of the paid-up share capital and other equity.
- (8) Return on Net Worth (RoNW) is calculated as restated profit/(loss) for the period/year attributable to owners of the company divided by Net Worth.
- (9) NAV per Equity Share is calculated as Net Worth divided by the weighted average number of Equity Shares outstanding during the year/period post sub-division.

#### **EBITDA, EBITDA Margin and Net Debt / EBITDA Ratio**

The following table sets forth our EBITDA, EBITDA Margin and Net Debt / EBITDA Ratio, including a reconciliation of EBITDA, EBITDA Margin and Net Debt / EBITDA Ratio to our restated profits/(losses), as at and for the six months ended September 30, 2021, Fiscal 2021, Fiscal 2020 and Fiscal 2019.

(₹ in millions, except for percentages)

Particulars	As at and for the six months ended, September 30, 2021	As at and for the fiscal year ended March 31,		
		2021	2020	2019
<b>Revenue from operations (A)</b>	<b>14,128.42</b>	<b>19,561.04</b>	<b>22,186.14</b>	<b>28,265.18</b>
Other income (B)	69.51	102.39	103.19	80.98
<b>Total Income (C=A+B)</b>	<b>14,197.93</b>	<b>19,663.43</b>	<b>22,289.33</b>	<b>28,346.16</b>
<b>Restated profit/(loss) for the period/year (D)</b>	<b>279.47</b>	<b>111.48</b>	<b>(289.39)</b>	<b>(244.28)</b>
Add: Total tax expense (E)	3.86	86.33	42.97	68.76
Add: Finance costs (F)	182.21	378.05	448.85	527.63
Add: Depreciation and amortisation expense (G)	310.98	624.77	629.52	534.16
<b>EBITDA (H=D+E+F+G)</b>	<b>776.52</b>	<b>1,200.63</b>	<b>831.95</b>	<b>886.27</b>
<b>EBITDA Margin (I=H/C)</b>	<b>5.47%</b>	<b>6.11%</b>	<b>3.73%</b>	<b>3.13%</b>
<b>Net Debt (L):</b>				
<b>Debt (J=(1)+(2)+(3))</b>	<b>4,088.43</b>	<b>3,274.41</b>	<b>3,579.08</b>	<b>4,787.76</b>
Non-current borrowings (1)	466.88	487.65	525.68	456.21
Current borrowings (2)	2,369.29	1,603.26	1,274.49	2,051.58

Particulars	As at and for the six months ended, September 30, 2021	As at and for the fiscal year ended March 31,		
		2021	2020	2019
Vehicle floor plan (3)	1,252.26	1,183.50	1,778.91	2,279.97
Less: Cash and Bank Balances (K)**	<b>706.20</b>	<b>227.20</b>	<b>333.27</b>	<b>365.68</b>
<b>Net Debt (L=J-K)</b>	<b>3,382.23</b>	<b>3,047.21</b>	<b>3,245.81</b>	<b>4,422.08</b>
<b>Net Debt / EBITDA Ratio (M=L/H) (No of times)*</b>	<b>4.36</b>	<b>2.54</b>	<b>3.90</b>	<b>4.99</b>

\* Amounts for the six-month period ended September 30, 2021 are not annualised.

\*\* Cash and Bank Balances is defined as sum of Cash and Cash Equivalents and Other balances with banks.

### Net Profit Ratio

The following table sets forth our Net Profit Ratio for the six months ended September 30, 2021, Fiscal 2021, Fiscal 2020 and Fiscal 2019.

(in ₹ millions, except percentages)

Particulars	As at, or for the six months period ended, September 30, 2021	As at, or for the fiscal year ended, March 31,		
		2021	2020	2019
Revenue from operations (A)	14,128.42	19,561.04	22,186.14	28,265.18
Restated profit/(loss) for the period/year (B)	279.47	111.48	(289.39)	(244.28)
<b>Net Profit Ratio (C=B/A)</b>	<b>1.98%</b>	<b>0.57%</b>	<b>(1.30)%</b>	<b>(0.86)%</b>

### Return on Equity Ratio

The following table sets forth our Return on Equity Ratio for the six months ended September 30, 2021, Fiscal 2021, Fiscal 2020 and Fiscal 2019.

(in ₹ millions, except percentages)

Particulars	As at, or for the six months ended, September 30, 2021	As at, or for the fiscal year ended, March 31,		
		2021	2020	2019
Restated profit/(loss) for the period/year (A)	279.47	111.48	(289.39)	(244.28)
Total equity (B)	2,093.17	1,823.76	1,699.09	1,889.56
<b>Return on Equity Ratio (C=A/B)*</b>	<b>13.35%</b>	<b>6.11%</b>	<b>(17.03)%</b>	<b>(12.93)%</b>

\* Amounts for the six months period ended September 30, 2021 are not annualised

### Return on Capital Employed

The following table sets forth our Return on Capital Employed as at, and for the six months ended, September 30, 2021, Fiscal 2021, Fiscal 2020 and Fiscal 2019.

(in ₹ millions, except percentages)

Particulars	As at, or for the six months ended, September 30, 2021	As at, or for the fiscal year ended, March 31,		
		2021	2020	2019
<b>Debt (A=(1)+(2)+(3))</b>	<b>4,088.43</b>	<b>3,274.41</b>	<b>3,579.08</b>	<b>4,787.76</b>
Non-current borrowings (1)	466.88	487.65	525.68	456.21
Current borrowings (2)	2,369.29	1,603.26	1,274.49	2,051.58
Vehicle floor plan (3)	1,252.26	1,183.50	1,778.91	2,279.97
<b>Total equity (B)</b>	<b>2,093.17</b>	<b>1,823.76</b>	<b>1,699.09</b>	<b>1,889.56</b>
<b>Capital Employed (C=A+B)</b>	<b>6,181.60</b>	<b>5,098.17</b>	<b>5,278.17</b>	<b>6,677.32</b>
<b>Earnings before Interest &amp; Tax (EBIT) (F)</b>				
Restated profit/(loss) before tax (D)	283.33	197.81	(246.42)	(175.52)
Interest expenses on borrowings (E)	119.39	240.34	302.93	388.78
<b>EBIT (F = D+E)</b>	<b>402.72</b>	<b>438.15</b>	<b>56.51</b>	<b>213.26</b>
<b>Return on Capital Employed (G=F/C)*</b>	<b>6.51%</b>	<b>8.59%</b>	<b>1.07%</b>	<b>3.19%</b>

\* Amounts for the six months period ended September 30, 2021 are not annualised.

### **Net Worth, Return on Net Worth and NAV per Equity Share**

The following table sets forth our Net Worth, Return on Net Worth and NAV per Equity Share as at, and for the six months ended, September 30, 2021, Fiscal 2021, Fiscal 2020 and Fiscal 2019.

*(in ₹ millions, except percentages, number of Equity Shares and NAV per Equity Share)*

Particulars	As at, or for the six months ended, September 30, 2021	As at, or for the fiscal year ended, March 31,		
		2021	2020	2019
Paid-up share capital (A)	183.13	183.13	183.13	183.13
Other equity (B)	1,902.36	1,634.62	1,508.12	1,696.51
<b>Net Worth (C=A/B)</b>	<b>2,085.49</b>	<b>1,817.75</b>	<b>1,691.25</b>	<b>1,879.64</b>
Restated profit/(loss) attributable to the owners of the Company for the period/year (D)	277.80	113.31	(287.31)	(252.55)
<b>Return on Net Worth (E=D/C)*</b>	<b>13.32%</b>	<b>6.23%</b>	<b>(16.99)%</b>	<b>(13.44)%</b>
Weighted average number of Equity Shares outstanding during the period/year post sub-division (F)	36,625,620	36,625,620	36,625,620	36,049,904
<b>NAV per Equity Share (G=C/F)</b>	<b>56.93</b>	<b>49.62</b>	<b>46.17</b>	<b>52.14</b>

\* Amounts for the six months period ended September 30, 2021 are not annualised.

### **Overview of Revenue and Expenditure**

The following descriptions set forth information with respect to key components of our income statement.

#### **Revenue**

##### *Revenue from operations*

Revenue from operations comprises (i) revenue from the sale of products and services; and (ii) other operating revenues.

We derive revenue primarily from the sale of new automobiles and the provision of after-sales services and sales of spares, lubricants, accessories and other products. We retail new premium and luxury automobiles, which include Mercedes-Benz, Honda, Jeep, Volkswagen and Renault passenger vehicles and Ashok Leyland commercial vehicles. We are also engaged in the purchase and sale of pre-owned automobiles through Sheerdrive, pursuant to which we earn a commission on automobiles purchased by Sheerdrive through customer trade-ins at our dealerships. In connection with our vehicle sales, we also facilitate the sale of third-party financial products, such as insurance policies and vehicle finance in respect of which we typically receive a portion of the cost of the financing paid or sum assured by the customer for each transaction as a commission from the finance or insurance provider.

We also provide after-sales services to our customers, which includes repair and maintenance services and sale of spare parts, lubricants and accessories. Set forth below is a breakdown of our revenue from vehicle sales, revenue from sales of after-sales services and spare parts and allied revenue and financial products for the period/years indicated:

	Six months ended September 30, 2021		Fiscal 2021		Fiscal 2020		Fiscal 2019	
	Amount (₹ million)	Percentage of total (%)	Amount (₹ million)	Percentage of total (%)	Amount (₹ million)	Percentage of total (%)	Amount (₹ million)	Percentage of total (%)
Revenue from new passenger vehicle sales	9,947.59	70.41%	12,589.54	64.36%	15,430.87	69.55%	20,691.70	73.21%
Revenue from new commercial vehicle sales	1,405.32	9.95%	1,865.90	9.54%	1,229.74	5.54%	2,127.45	7.53%
Revenue from pre-owned vehicle sales	77.02	0.55%	347.97	1.78%	208.17	0.94%	132.43	0.47%
<b>Revenue from sale of cars</b>	<b>11,429.93</b>	<b>80.90%</b>	<b>14,803.41</b>	<b>75.68%</b>	<b>16,868.78</b>	<b>76.03%</b>	<b>22,951.58</b>	<b>81.20%</b>
Revenue from sale of spares, lubricants and others	1,643.66	11.63%	2,906.72	14.86%	3,360.86	15.15%	3,298.51	11.67%
Revenue from sale of services	786.49	5.57%	1,322.84	6.76%	1,445.54	6.52%	1,303.65	4.61%
<b>Revenue from sale of products and services</b>	<b>13,860.08</b>	<b>98.10%</b>	<b>19,032.97</b>	<b>97.30%</b>	<b>21,675.18</b>	<b>97.70%</b>	<b>27,553.74</b>	<b>97.48%</b>
Other operating revenue:								
Financial products (Insurance and vehicle finance)	90.37	0.64%	139.48	0.71%	208.01	0.94%	262.24	0.93%
Others	177.97	1.26%	388.59	1.99%	302.95	1.36%	449.20	1.59%
<b>Revenue from operations</b>	<b>14,128.42</b>	<b>100.00%</b>	<b>19,561.04</b>	<b>100.00%</b>	<b>22,186.14</b>	<b>100.00%</b>	<b>28,265.18</b>	<b>100.00%</b>

No geographical information is presented as our revenue is generated entirely within India.

#### *Other income*

Other income primarily comprises interest income, sundry balances written back, marketing support income, interest on security deposits, amongst others.

#### *Expenses*

Our expenses comprise the following:

- Purchase of cars, spares and others: Purchase of cars, spares and others comprises the purchase cost of automobiles and the purchase cost of automobile parts and accessories from our OEMs and other vendors.
- Changes in inventories of stock-in-trade: Changes in inventories of stock-in-trade denotes increase/decrease in inventories of stock-in-trade (cars and spares and others) between opening and closing dates of a reporting period.
- Employee benefit expenses: Employee benefit expenses include (i) salaries and wages, (ii) gratuity expenses, (iii) contributions to provident and other funds, (iv) expenses on employee stock option scheme, and (v) staff welfare expenses.
- Finance costs: Finance costs comprise interest expenses on (i) financial liabilities carried at amortised cost, (ii) lease liabilities, (iii) delayed payment of income tax, (iv) other interests paid, and (v) other borrowing costs.
- Depreciation and amortisation expenses: Depreciation and amortisation expenses comprise (i) depreciation on property, plant and equipment, (ii) amortisation of intangible assets, and (iii) amortisation on right of use assets.
- Other expenses: Other expenses comprise primarily of: (i) job work charges; (ii) advertising and sales promotion;

(iii) new car delivery expenses; (iv) repair expenses, which includes payments for common area maintenance charges at our buildings, annual maintenance charges for plant and machineries and general repair and maintenance; (v) electricity expenses; (vi) housekeeping and pantry expenses; (vii) rent, (viii) commission expense; and (ix) legal and professional, which comprise payments made to auditors, lawyers and other professional advisers, amongst others.

Set forth below is a breakdown of our total expenses as a percentage of our revenue from operations for the period/years indicated.

	Six months ended September 30, 2021		Fiscal 2021		Fiscal 2020		Fiscal 2019	
	Amount (₹ million)	Percentage of total (%)	Amount (₹ million)	Percentage of total (%)	Amount (₹ million)	Percentage of total (%)	Amount (₹ million)	Percentage of total (%)
Purchase of cars, spares and others	12,768.26	90.37	17,104.29	87.44	17,808.48	80.27	24,776.35	87.66
Changes in inventories of stock-in-trade	(554.67)	(3.93)	(630.59)	(3.22)	1,140.33	5.14	(151.01)	(0.53)
Employee benefits expense	674.60	4.77	1,076.66	5.50	1,367.39	6.16	1,522.63	5.39
Finance costs	182.21	1.29	378.05	1.93	448.85	2.02	527.63	1.87
Depreciation and amortisation expenses	310.98	2.20	624.77	3.19	629.52	2.84	534.16	1.89
Other expenses	533.22	3.77	912.44	4.66	1,141.18	5.14	1,311.92	4.64
<b>Total expenses</b>	<b>13,914.60</b>	<b>98.49</b>	<b>19,465.62</b>	<b>99.51</b>	<b>22,535.75</b>	<b>101.58</b>	<b>28,521.68</b>	<b>100.91</b>

### *Tax Expenses*

Our tax expenses represent the tax payable on the current period's taxable income based on the applicable income tax rate adjusted by income tax payable for earlier years and deferred tax charges or credit (reflecting the tax effects of timing differences between accounting income and taxable income for the period). Tax expenses constituted 0.03%, 0.44%, 0.19% and 0.24% of our revenue from operations in the six-month period ended September 30, 2021 and in Fiscals 2021, 2020 and 2019, respectively.

The deferred tax charge or credit and the corresponding deferred tax liabilities or assets are recognized using the tax rates that have been enacted or substantively enacted by the balance sheet date and are expected to apply to taxable income in the years in which those temporary differences are expected to be recovered or settled. Deferred tax liabilities are generally recognized for all taxable temporary differences. Deferred tax assets are generally recognized for all deductible temporary differences to the extent that it is probable that taxable profits will be available against the deductible temporary differences that can be utilized. Deferred tax is reviewed at each balance sheet date and written down or written up to reflect the amount that is reasonably certain, as the case may be, to be realized.

### **Operating Segment**

The primary reporting of the Group has been made on the basis of Business Segments. The Group has a single business segment as defined in Indian Accounting Standard (Ind AS) 108 on Segment Reporting, namely dealership of cars in India. The managing director of the group allocates resources and assesses the performance of the group, thus is the chief operating decision maker (CODM). The CODM monitors the operating results of the business as a single segment, hence no separate segment needs to be disclosed.

### **Business Line Results Summary**

Although we have a single business segment, we have been managing our business based on two business lines. Our vehicle sales and allied products business line comprises our sales of new vehicles and the commissions that we receive from distribution of third-party financial products (including insurance and vehicle finance) and pre-owned vehicles purchases and sales made by Sheerdrive through our dealerships. Our after-sales services and spare parts business comprises our after-sales services and repairs and sales of spare parts, lubricants and accessories.

We present the following non-GAAP financial measures that is not prepared in accordance with Ind AS, including revenue, EBITDA and EBITDA Margin of each business line. We present these non-GAAP financial measures because



we use them to measure the operating performance of our business lines and as a basis for our strategic planning. We believe that non-GAAP financial information, when taken collectively with financial measures prepared in accordance with Ind AS, may be helpful to investors because it provides an additional tool for investors to use in evaluating our ongoing operating results and trends. However, these non-GAAP financial measures should not be considered as alternatives to or substitutes for an analysis of our results of operations prepared in accordance with Ind AS, or as measures of profitability or liquidity, and may not be in comparable to similarly titled information published by other companies in our industry. For further information on non-GAAP financial measures, please see “- Key Performance Indicators and non-GAAP Financial Measures” on page 289.

The following table of financial data, EBITDA and EBITDA Margin, broken down by business line, is for the six months ended September 30, 2021, Fiscal 2021, Fiscal 2020 and Fiscal 2019.

(in ₹ in millions, except for percentages and vehicle numbers)

Particulars	For the six months ended, September 30, 2021	For the fiscal year ended March 31,		
		2021	2020	2019
<b>Sales volumes</b>				
Number of new vehicles sold	8,295	13,282	16,730	22,118
Number of vehicles serviced	132,680	221,468	291,040	271,906
<b>Vehicle sales and allied products</b>				
New vehicles	11,461.83	14,722.76	16,912.52	23,198.08
Financial products (Insurance and vehicle finance)	90.37	139.48	208.01	262.24
Pre-owned vehicles income	82.09	353.65	231.42	163.36
<b>Total vehicle sales and other operating products revenue</b>	<b>11,634.29</b>	<b>15,215.89</b>	<b>17,351.95</b>	<b>23,623.68</b>
EBITDA	254.11	368.14	(96.93)	14.04
EBITDA Margin	2.18%	2.42%	(0.56)%	0.06%
<b>After-sales services and spare parts*</b>				
<b>Total revenue</b>	<b>2,494.13</b>	<b>4,345.15</b>	<b>4,834.19</b>	<b>4,641.50</b>
EBITDA	460.57	771.12	865.83	804.89
EBITDA Margin	18.47%	17.75%	17.91%	17.34%
Add: Other Income	69.51	102.39	103.19	80.98
Less: Unallocable expense^	7.67	41.02	40.14	13.64
<b>Total EBITDA</b>	<b>776.52</b>	<b>1,200.63</b>	<b>831.95</b>	<b>886.27</b>
<b>Total EBITDA Margin</b>	<b>5.47%</b>	<b>6.11%</b>	<b>3.73%</b>	<b>3.13%</b>

**Notes:**

\* After-sales service and spare parts revenue includes sales spare parts, lubricants, accessories and others.

^ Unallocable expense comprises of loss on property, plant and equipment sold /written off, expenditure on CSR and donations and contributions.

**Results of Operations based on our Restated Consolidated Financial Information**

Set forth below is certain financial information based on our Restated Consolidated Financial Information for the six-month period ended September 30, 2021 and for Fiscals 2021, 2020 and 2019, the components of which are also expressed as a percentage of our total income, for the periods indicated.

	Six months ended September 30, 2021		Fiscal 2021		Fiscal 2020		Fiscal 2019	
	Amount (₹ million)	Percentage of total (%)	Amount (₹ million)	Percentage of total (%)	Amount (₹ million)	Percentage of total (%)	Amount (₹ million)	Percentage of total (%)
<b>Income</b>								
Revenue from operations	14,128.42	99.51	19,561.04	99.48	22,186.14	99.54	28,265.18	99.71
Other income	69.51	0.49	102.39	0.52	103.19	0.46	80.98	0.29
<b>Total income</b>	<b>14,197.93</b>	<b>100.00</b>	<b>19,663.43</b>	<b>100.00</b>	<b>22,289.33</b>	<b>100.00</b>	<b>28,346.16</b>	<b>100.00</b>

	Six months ended September 30, 2021		Fiscal 2021		Fiscal 2020		Fiscal 2019	
	Amount (₹ million)	Percentage of total (%)	Amount (₹ million)	Percentage of total (%)	Amount (₹ million)	Percentage of total (%)	Amount (₹ million)	Percentage of total (%)
<b>Expenses</b>								
Purchase of cars, spares and others	12,768.26	89.93	17,104.29	86.99	17,808.48	79.90	24,776.35	87.41
Changes in inventories of stock-in-trade	(554.67)	(3.91)	(630.59)	(3.21)	1,140.33	5.12	(151.01)	(0.53)
Employee benefits expense	674.60	4.75	1,076.66	5.48	1,367.39	6.13	1,522.63	5.37
Finance costs	182.21	1.28	378.05	1.92	448.85	2.01	527.63	1.86
Depreciation and amortisation expenses	310.98	2.19	624.77	3.18	629.52	2.82	534.16	1.88
Other expenses	533.22	3.76	912.44	4.64	1,141.18	5.12	1,311.92	4.63
<b>Total expenses</b>	<b>13,914.60</b>	<b>98.00</b>	<b>19,465.62</b>	<b>98.99</b>	<b>22,535.75</b>	<b>101.11</b>	<b>28,521.68</b>	<b>100.62</b>
<b>Restated profit / (loss) before tax</b>	<b>283.33</b>	<b>2.00</b>	<b>197.81</b>	<b>1.01</b>	<b>(246.42)</b>	<b>(1.11)</b>	<b>(175.52)</b>	<b>(0.62)</b>
<b>Tax expense</b>								
Current tax	61.45	0.44	103.08	0.53	12.81	0.06	55.73	0.19
Deferred tax	(57.59)	(0.41)	(16.75)	(0.09)	30.16	0.13	13.03	0.05
<b>Total tax expense</b>	<b>3.86</b>	<b>0.03</b>	<b>86.33</b>	<b>0.44</b>	<b>42.97</b>	<b>0.19</b>	<b>68.76</b>	<b>0.24</b>
<b>Restated profit / (loss) for the period / year</b>	<b>279.47</b>	<b>1.97</b>	<b>111.48</b>	<b>0.57</b>	<b>(289.39)</b>	<b>(1.30)</b>	<b>(244.28)</b>	<b>(0.86)</b>

### Six months ended September 30, 2021

Our results of operations for the six months ended September 30, 2021 were particularly impacted by the following factors:

- Business activity was adversely impacted by the second wave of COVID-19 infections that impacted India in April, May and June 2021.
- Purchase, logistics and other costs increased generally due to a higher inflationary trend during the period, which may continue for the remainder of Fiscal 2022.
- The global shortage of semiconductor chips has affected OEMs and their ability to produce automobiles in a timely manner to meet demand, which has resulted in delays in receipt of shipments from OEMs.

### Income

Our total income was ₹14,197.93 million for the six months ended September 30, 2021, of which ₹14,128.42 million, or 99.51%, was derived from revenue from operations.

### Revenue from Operations

Our revenue from operations was ₹14,128.42 million in the six months ended September 30, 2021. For the six months ended September 30, 2021:

- our revenue from sales of cars was ₹11,429.93 million;
- our revenue from sales of spares, lubricants and others was ₹1,643.66 million;
- our revenue from sale of services was ₹786.49 million; and
- our other operating revenues was ₹268.34 million.

### *Other Income*

Our other income was ₹69.51 million in the six months ended September 30, 2021 and principally comprised interest income of ₹25.57 million, sundry balances written back of ₹11.96 million, gain on termination of lease of ₹11.39 million, marketing support income of ₹9.44 million, excess provision written back of ₹5.33 million and proceeds from an insurance claim of ₹5.00 million.

### *Expenses*

#### *Purchase of Cars, Spares and Others*

Our purchase of cars, spares and others was ₹12,768.26 million in the six months ended September 30, 2021, which comprised purchases of cars of ₹11,334.21 million and purchases of spares, lubricants and others of ₹1,434.05 million.

#### *Change in Inventories of Stock-in-Trade*

As at April 1, 2021, our opening stock-in-trade of (i) cars was ₹2,402.07 million, and (ii) spares and others was ₹486.15 million. As at September 30, 2021, our closing stock-in-trade of (i) cars was ₹2,879.93 million, and (ii) spares and others was ₹562.96 million. As a result, we had a net increase in our change in inventories of stock-in-trade of ₹(554.67) million in the six months ended September 30, 2021.

#### *Cost of Goods Sold*

When considered together, our Cost of Goods Sold (which is the aggregate of our purchase of cars, spares and others and changes in inventories of stock-in-trade) was ₹12,213.59 million for the six months ended September 30, 2021, which represented 86.02% of total income for the period.

#### *Employee Benefits Expense*

Our employee benefits expense was ₹674.60 million in the six months ended September 30, 2021, which principally comprised salaries and wages of ₹637.70 million, gratuity expenses of ₹7.54 million, contributions to provident and other funds of ₹14.55 million, share based payment expense of ₹0.51 million and staff welfare expenses of ₹14.30 million.

#### *Finance Costs*

Our finance costs were ₹182.21 million in the six months ended September 30, 2021, which primarily comprised interest expenses on (i) financial liabilities carried at amortised cost of ₹119.39 million and (ii) lease liabilities of ₹56.36 million.

#### *Depreciation and Amortisation Expenses*

Our depreciation and amortisation expenses were ₹310.98 million in the six months ended September 30, 2021, which primarily comprised amortisation on right of use assets of ₹182.16 million and depreciation on property, plant and equipment of ₹122.11 million.

#### *Other Expenses*

Our other expenses were ₹533.22 million in the six months ended September 30, 2021. Other expenses for the period primarily comprised of (i) job work charges of ₹120.37 million, (ii) advertisement and sales promotion of ₹57.53 million, (iii) new car delivery expenses of ₹44.68 million, (iv) electricity expenses of ₹39.57 million, and (v) repairs expenses of ₹33.90 million.

#### *Restated Profit / (Loss) Before Tax*

As a result of the foregoing, we recorded a restated profit before tax of ₹283.33 million in the six months ended September 30, 2021.

#### *Tax expenses*

For the six months ended September 30, 2021, our current tax was ₹61.45 million and our deferred tax credit was ₹(57.59) million. As a result, our tax expenses were ₹3.86 million in the six months ended September 30, 2021.

### Restated Profit / (Loss) for the Year

As a result of the foregoing, we recorded a restated profit for the year of ₹279.47 million in the six months ended September 30, 2021.

### Results of operations for Fiscal 2021 compared with Fiscal 2020

(₹ in millions, except percentages)

Particulars	For the year ended March 31,		Change (%)
	2021	2020	
<b>Income</b>			
Revenue from operations	19,561.04	22,186.14	(11.83)
Other income	102.39	103.19	(0.78)
<b>Total income</b>	<b>19,663.43</b>	<b>22,289.33</b>	<b>(11.78)</b>
<b>Expenses</b>			
Purchase of cars, spares and others	17,104.29	17,808.48	(3.95)
Changes in inventories of stock-in-trade	(630.59)	1,140.33	(155.30)
Employee benefits expense	1,076.66	1,367.39	(21.26)
Finance costs	378.05	448.85	(15.77)
Depreciation and amortisation expense	624.77	629.52	(0.75)
Other expenses	912.44	1,141.18	(20.04)
<b>Total expenses</b>	<b>19,465.62</b>	<b>22,535.75</b>	<b>(13.62)</b>
<b>Restated profit / (loss) before tax</b>	<b>197.81</b>	<b>(246.42)</b>	<b>(180.27)</b>
<b>Tax expense:</b>			
Current tax	103.08	12.81	704.68
Deferred tax	(16.75)	30.16	(155.54)
<b>Total tax expense</b>	<b>86.33</b>	<b>42.97</b>	<b>100.91</b>
<b>Restated profit / (loss) for the year</b>	<b>111.48</b>	<b>(289.39)</b>	<b>(138.52)</b>

Our results of operations during Fiscal 2021 were significantly impacted by the COVID-19 pandemic and the corresponding lockdowns imposed across various parts of the country during this period. Related preventive and protective actions include the complete suspension of activities at our showrooms, sales outlets and booking offices and service centres, which were completely shut during a few parts of Fiscal 2021.

### Total Income

Our total income decreased by 11.78% to ₹19,663.43 million for Fiscal 2021 from ₹22,289.33 million for Fiscal 2020. In Fiscal 2021 and Fiscal 2020, our revenue from operations constituted 99.48% and 99.54% of our total income, respectively.

### Revenue from Operations

Our revenue from operations decreased by 11.83% to ₹19,561.04 million for Fiscal 2021 from ₹22,186.14 million for Fiscal 2020. This decrease can be primarily attributed to a (i) 12.24% decrease in revenue from sales of cars, (ii) 13.51% decrease in revenue from sales of spares, lubricants and others, and (iii) 8.49% decrease in revenue from the sale of services. These decreases were primarily the result of the impact of the COVID-19 pandemic and associated lockdowns across the country during Fiscal 2021.

Our other operating revenues increased by 3.35% to ₹528.07 million for Fiscal 2021 from ₹510.96 million for Fiscal 2020, which increase was primarily due to additional support provided by our OEMs during the COVID-19 pandemic for Fiscal 2021.

### Other Income

Our other income decreased by 0.78% to ₹102.39 million in Fiscal 2021 from ₹103.19 million in Fiscal 2020.

### Expenses

#### Purchase of Cars, Spares and Others

Our purchase of cars, spares and others decreased by 3.95% to ₹17,104.29 million in Fiscal 2021 from ₹17,808.48 million in Fiscal 2020. This decrease was primarily due to a decrease in sales of cars, accessories and spare parts due to prevailing economic conditions.

#### *Change in Inventories of Stock-in-Trade*

Our change in inventories of stock-in-trade went from a decrease of ₹1,140.33 million in Fiscal 2020 to an increase of ₹(630.59) million in Fiscal 2021. This was primarily a result of the sale of the entire stock of Bharat Emission Stage IV engine vehicles as at March 31, 2020 when some of the OEMs had not even started selling Bharat Emission Stage VI engine vehicles.

Our opening stock of (i) cars was ₹1,811.95 million as at April 1, 2020, while it was ₹2,952.04 million as at April 1, 2019, and (ii) spares and others was ₹445.68 million as at April 1, 2020, while it was ₹445.92 million as at April 1, 2019. Our closing stock of (i) cars was ₹2,402.07 million as at March 31, 2021, while it was ₹1,811.95 million as at March 31, 2020, and (ii) spares and others was ₹486.15 million as at March 31, 2021, while it was ₹445.68 million as at March 31, 2020.

#### *Cost of Goods Sold*

When considered together, our Cost of Goods Sold (which is the aggregate of our purchase of cars, spares and others and changes in inventories of stock-in-trade) has decreased slightly as a percentage of revenue from operations from 85.41% for Fiscal 2020 to 84.22 % for Fiscal 2021. The principal reason for such decrease is due to the higher discounts we offered to customers in Fiscal 2020 to sell our entire stock of Bharat Emission Stage IV engine vehicles.

#### *Employee Benefits Expense*

Our employee benefits expense decreased by 21.26% to ₹1,076.66 million in Fiscal 2021 from ₹1,367.39 million in Fiscal 2020. This decrease was primarily due to a decrease of ₹265.70 million, or 20.71%, in salaries and wages as a result of a decline in our headcount and employee related expenses during this period caused by the impact of the COVID-19 pandemic.

#### *Finance Costs*

Our finance costs decreased by 15.77% to ₹378.05 million in Fiscal 2021 from ₹448.85 million in Fiscal 2020. This decrease was primarily due to a decrease of ₹62.59 million, or 20.66%, in interest expenses on financial liabilities carried at amortised cost primarily due to a lower utilization of inventory funding facilities and a reduction in interest rates.

#### *Depreciation and Amortisation Expense*

Our depreciation and amortisation expenses were ₹624.77 million in Fiscal 2021 as compared to ₹629.52 million in Fiscal 2020. Our depreciation and amortisation expense remained relatively unchanged.

#### *Other Expenses*

Our other expenses decreased by 20.04% to ₹912.44 million in Fiscal 2021 from ₹1,141.18 million in Fiscal 2020. The decrease was mainly driven by (i) a decrease of ₹93.06 million, or 48.50%, in advertisement and sales promotion, (ii) a decrease of ₹25.16 million, or 39.50%, in rent, (iii) a decrease of ₹20.73 million, or 24.62%, in new car delivery expenses, (iv) a decrease of ₹20.44 million, or 25.15%, in electricity expenses, and (v) a decrease of ₹25.52 million, or 46.79%, in travelling and conveyance, all of which was a result of the impact of the COVID-19 pandemic on our business and operations.

#### *Restated Profit / (Loss) Before Tax*

As a result of the foregoing, we recorded a profit before tax of ₹197.81 million in Fiscal 2021, as compared to loss before tax of ₹(246.42) million in Fiscal 2020.

#### *EBITDA and EBITDA Margin*

Our EBITDA increased by ₹368.68 million, or 44.32%, from ₹831.95 million in Fiscal 2020 to ₹1,200.63 million in Fiscal 2021. Our EBITDA Margin improved from 3.73% in Fiscal 2020 to 6.11% in Fiscal 2021. Such increases were

driven by a mix of factors. In terms of our vehicle sales and allied products business line, we increased margins in Fiscal 2021 from the sale of cars due to fewer discounts offered (e.g., higher discounts were offered to customers in Fiscal 2020 to sell our entire stock of Bharat Emission Stage IV engine vehicles) and increased margins offered by OEMs. As a result, our EBITDA margin for vehicle sales and allied products business line increased from (0.56%) in Fiscal 2020 to 2.42% in Fiscal 2021. In terms of our after-sales services and spare parts business line, margins in Fiscal 2021 were in line with that of Fiscal 2020. The EBITDA margin for our after-sales services and spare parts business line was 17.91% in Fiscal 2020 and 17.75% in Fiscal 2021. Furthermore, we took measures to reduce our fixed costs and borrowing costs in Fiscal 2021.

#### *Tax expense*

Our tax expense increased by 100.91% to ₹86.33 million in Fiscal 2021 from ₹42.97 million in Fiscal 2020, which was primarily due to (i) the profits before tax in Fiscal 2021 as compared to the loss before tax recorded in Fiscal 2020, and (ii) the application of a deferred tax credit of ₹(16.75) million in Fiscal 2021, as compared to a deferred tax charge of ₹30.16 million in Fiscal 2020.

#### *Restated Profit / (Loss) for the Year*

As a result of the foregoing, we recorded a profit for the year of ₹111.48 million in Fiscal 2021 as compared to a loss for the year of ₹(289.39) million in Fiscal 2020.

#### *Results of operations for Fiscal 2020 compared with Fiscal 2019*

(₹ in millions, except percentages)

Particulars	For the year ended March 31,		Change (%)
	2020	2019	
<b>Income</b>			
Revenue from operations	22,186.14	28,265.18	(21.51)
Other income	103.19	80.98	27.43
<b>Total income</b>	<b>22,289.33</b>	<b>28,346.16</b>	<b>(21.37)</b>
<b>Expenses</b>			
Purchase of cars, spares and others	17,808.48	24,776.35	(28.12)
Changes in inventories of stock-in-trade	1,140.33	(151.01)	(855.14)
Employee benefits expense	1,367.39	1,522.63	(10.20)
Finance costs	448.85	527.63	(14.93)
Depreciation and amortisation expense	629.52	534.16	17.85
Other expenses	1,141.18	1,311.92	(13.01)
<b>Total expenses</b>	<b>22,535.75</b>	<b>28,521.68</b>	<b>(20.99)</b>
<b>Restated profit / (loss) before tax</b>	<b>(246.42)</b>	<b>(175.52)</b>	<b>40.39</b>
<b>Tax expenses:</b>			
Current tax	12.81	55.73	(77.01)
Deferred tax	30.16	13.03	131.47
<b>Total tax expenses</b>	<b>42.97</b>	<b>68.76</b>	<b>(37.51)</b>
<b>Restated profit / (loss) for the year</b>	<b>(289.39)</b>	<b>(244.28)</b>	<b>18.47</b>

#### *Total Income*

Our total income decreased by 21.37% to ₹22,289.33 million in Fiscal 2020 from ₹28,346.16 million in Fiscal 2019. In Fiscal 2020 and Fiscal 2019, our revenue from operations constituted 99.54% and 99.71% of our total income, respectively.

#### *Revenue from Operations*

Our revenue from operations decreased by 21.51% to ₹22,186.14 million in Fiscal 2020 from ₹28,265.18 million in Fiscal 2019. This decrease can be primarily attributed to a 26.50% decrease in revenue from sales of cars as a result of the adverse impacts caused by the COVID-19 pandemic (including the lockdown imposed during the second half of March 2020) and the nationwide economic slowdown in the automobile industry during Fiscal 2020. Revenue from sales of services, spares, lubricants and others marginally increased by 4.44%.

Our other operating revenues decreased by 28.18% to ₹510.96 million for Fiscal 2020 from ₹711.44 million for Fiscal 2019, which was primarily due to a decrease in revenue from sales of cars as a result of the economic slowdown in the automobile industry and the lockdown imposed during the second half of March 2020.

#### *Other Income*

Our other income increased by 27.43% to ₹103.19 million in Fiscal 2020 from ₹80.98 million in Fiscal 2019. Such increase was primarily attributable to a ₹19.92 million increase in interest income and a ₹10.88 million increase in sundry balances written back, which was partially offset by a decrease of ₹12.31 million in proceeds from insurance claim.

#### *Expenses*

##### *Purchase of Cars, Spares and Others*

Our purchase of cars, spares and others decreased by 28.12% to ₹17,808.48 million in Fiscal 2020 from ₹24,776.35 million in Fiscal 2019. This decrease was primarily due to a decrease of ₹7,076.76 million, or 31.89%, in the purchase of cars as a result of a decline in the demand for new vehicles on account of the economic slowdown and nation-wide lock down due to the COVID-19 pandemic that commenced from the second half of March 2020.

##### *Change in Inventories of Stock-in-Trade*

Our change in inventories of stock-in-trade went from an increase of ₹(151.01) million in Fiscal 2019 to a decrease of ₹1,140.33 million in Fiscal 2020, due to the sale of all the Bharat Emission Stage IV engine vehicles.

Our opening stock of (i) cars was ₹2,952.04 million as at April 1, 2019, while it was ₹2,841.61 million as at April 1, 2018, and (ii) spares and others was ₹445.92 million as at April 1, 2019, while it was ₹405.34 million as at April 1, 2018.

Our closing stock of (i) cars was ₹1,811.95 million as at March 31, 2020, while it was ₹2,952.04 million as at March 31, 2019, and (ii) spares and others was ₹445.68 million as at March 31, 2020, while it was ₹445.92 million as at March 31, 2019.

##### *Cost of Goods Sold*

When considered together, our Cost of Goods Sold (which is the aggregate of our purchase of cars, spares and others and changes in inventories of stock-in-trade) has increased as a percentage of revenue from operations from 87.12% for Fiscal 2019 to 85.41% for Fiscal 2020. The principal reason for such increase is on account of the higher discounts offered to customers in Fiscal 2020 to sell our entire stock of Bharat Emission Stage IV engine vehicles.

##### *Employee Benefits Expense*

Our employee benefits expense decreased by 10.20% to ₹1,367.39 million in Fiscal 2020 from ₹1,522.63 million in Fiscal 2019. This decrease was primarily due to a decrease of ₹87.23 million, or 6.37%, in salaries and wages as a result of a voluntary waiver of remuneration by the directors and no incremental wage increases given to employees in Fiscal 2020 due to the economic slowdown in the automobile industry, and a decrease of ₹53.07 million in expenses on employee stock option scheme.

##### *Finance Costs*

Our finance costs decreased by 14.93% to ₹448.85 million in Fiscal 2020 from ₹527.63 million in Fiscal 2019. This decrease was primarily due to a decrease of ₹85.85 million, or 22.08%, in interest expenses on financial liabilities carried at amortised cost as a result of a reduction in utilization of inventory funding facilities on account of fewer purchases of vehicles due to the economic slowdown in automobile industry.

##### *Depreciation and Amortisation Expenses*

Our depreciation and amortisation expenses increased by 17.85% to ₹629.52 million in Fiscal 2020 from ₹534.16 million in Fiscal 2019, primarily due to an increase of ₹62.79 million, or 21.90%, in amortisation on right of use assets and an increase of ₹28.47 million, or 11.92%, in depreciation on property, plant and equipment, mainly due to addition of a new showroom/workshop and a new addition to right of use asset.

### *Other Expenses*

Our other expenses decreased by 13.01% to ₹1,141.18 million in Fiscal 2020 from ₹1,311.92 million in Fiscal 2019, which was mainly driven by (i) a decrease of ₹68.49 million, or 51.82%, in rent due to leases which expired prior to March 31, 2019, as right of use assets were not created on leases which completed in Fiscal 2020, and (ii) a decrease of ₹56.69 million, or 22.81%, in advertisement and sales promotion due to lower spend on sales promotion activities due to the economic slowdown in automobile industry.

### *Restated Profit / (Loss) Before Tax*

As a result of the foregoing, we recorded an increased loss before tax of ₹(246.42) million in Fiscal 2020 as compared to ₹(175.52) million in Fiscal 2019.

### *EBITDA and EBITDA Margin*

Our EBITDA decreased by ₹54.32 million, or 6.13%, from ₹886.27 million in Fiscal 2019 to ₹831.95 million in Fiscal 2020. Our EBITDA Margin improved from 3.13% in Fiscal 2019 to 3.73% in Fiscal 2020. Our EBITDA margins for our vehicle sales and allied products business line decreased from 0.06% in Fiscal 2019 to (0.56)% in Fiscal 2020 on account of the higher discounts offered to customers in Fiscal 2020 to sell our entire stock of Bharat Emission Stage IV engine vehicles. Such margin compression was partially mitigated by an increase in EBITDA margins for our after-sales services and spare parts business line, which increased from 17.34% in Fiscal 2019 to 17.91% in Fiscal 2020, as a result of an expansion of our after-sales services and spare parts business.

### *Tax expenses*

Our tax expenses decreased by 37.51% to ₹42.97 million in Fiscal 2020 from ₹68.76 million in Fiscal 2019, primarily because of our increased loss before tax in Fiscal 2020.

### *Restated Profit / (Loss) for the Year*

As a result of the foregoing, we recorded a 18.47% increase in our loss for the year to ₹(289.39) million in Fiscal 2020 from ₹(244.28) million in Fiscal 2019.

## **Liquidity and Capital Resources**

### ***Capital Requirements***

Our principal capital requirements are to finance purchases of new automobiles from OEMs, purchasing automobile parts and accessories, payment of principal and interest on our borrowings, capital expenditure and operating expenses, such as rent, employee benefits expense and administrative expenses. Our principal source of funding has been, and is expected to be, cash generated from our operations, equity infusions from shareholders, supplemented by borrowings from banks and financial institutions and optimization of operating working capital. For the six months ended September 30, 2021, Fiscal 2021, Fiscal 2020 and Fiscal 2019, we met our funding requirements, including satisfaction of debt obligations, capital expenditure, investments, other working capital requirements, and other cash outlays, principally with funds generated from operations, optimization of operating working capital with the balance met from external borrowings and borrowings from Promoters/related parties.

Effective as of October 1, 2021, we entered into agency agreements with Mercedes-Benz, under which we are an authorized agent of Mercedes-Benz on a non-exclusive basis in Gujarat, Maharashtra, Madhya Pradesh and West Bengal. As the new agency model, we no longer purchase cars from Mercedes-Benz and we will no longer carry inventory of Mercedes-Benz cars, except for demo cars. Instead, customers will place orders through us to Mercedes-Benz on which we will earn a commission. Previously, as an authorized dealer, we purchased cars and then resold them to customers, requiring us to finance such purchases and carry inventory, thereby tying up working capital. As we will no longer need to carry inventory of Mercedes-Benz cars from October 1, 2021, we expect that this change to an agency model will significantly reduce our working capital requirements, thereby allowing us to allocate our available working capital to other uses, including investments in our growth initiatives, and improve our Return on Capital Employed.



## Liquidity

Our liquidity requirements arise principally for our operating activities, capital expenditures for construction of new facilities and undertaking of new projects, repayment of borrowings and debt service obligations. Historically, our principal sources of funding have included cash generated from operations, short-term and long-term borrowings from banks, credit granted by suppliers, cash and cash equivalents and equity and financing provided by our Promoters/related parties. We have also entered into inventory funding facilities with banks/financial institutions with whom we have made arrangements to finance our cars and spare parts and accessory purchases from OEMs.

We had cash and cash equivalents of ₹586.95 million, ₹150.34 million, ₹277.01 million and ₹322.44 million as of September 30, 2021, March 31, 2021, March 31, 2020 and March 31, 2019, respectively.

## Cash Flows

The following table summarizes our cash flows for the six months ended September 30, 2021, Fiscal 2021, Fiscal 2020 and Fiscal 2019:

Particulars	For the six-month period ended September 30, 2021	For the year ended March 31,		
		2021	2020	2019
Net Cash generated from Operating Activities	182.52	427.64	2,096.60	548.85
Net Cash (used in) Investing Activities	(111.29)	(220.28)	(659.13)	(379.38)
Net Cash generated from/(used in) Financing Activities	365.38	(334.03)	(1,482.90)	(275.63)
<b>Net Increase / (Decrease) in Cash and Cash Equivalents</b>	<b>436.61</b>	<b>(126.67)</b>	<b>(45.43)</b>	<b>(106.16)</b>
Cash and Cash Equivalents at the beginning of the year	150.34	277.01	322.44	428.60
<b>Cash and Cash Equivalents at the end of the year</b>	<b>586.95</b>	<b>150.34</b>	<b>277.01</b>	<b>322.44</b>

(₹ in millions)

### Cash flows generated from operating activities

We generated ₹182.52 million net cash from operating activities for the six-month period ended September 30, 2021. While our restated profit before tax was ₹283.33 million, we had an operating profit before working capital changes of ₹729.98 million, primarily due to adjustments for depreciation and amortisation expense of ₹310.99 million and finance costs of ₹182.21 million, which were partially offset by interest income of ₹25.58 million, sundry balances written back (net) of ₹11.96 million and a gain on termination of lease of ₹11.39 million. Our adjustments for working capital changes for the six months period ended September 30, 2021 primarily consisted of increase in inventories of ₹554.67 million and trade receivables of ₹139.92 million, which were partially offset by a decrease in other assets of ₹71.45 million and increase in other liabilities of ₹79.90 million, vehicle floor plan of ₹68.76 million and trade payables of ₹67.37 million. Our cash generated from operations was ₹315.70 million, adjusted by direct taxes paid (net) of ₹133.18 million.

We generated ₹427.64 million net cash from operating activities during Fiscal 2021. While our restated profit before tax was ₹197.81 million, we had an operating profit before working capital changes of ₹1,164.40 million, primarily due to adjustments for depreciation and amortisation expense of ₹624.77 million and finance costs of ₹378.05 million, which were partially offset by interest income of ₹50.62 million and sundry balances written back (net) of ₹31.49 million. Our adjustments for working capital changes for Fiscal 2021 primarily consisted of increase in inventories of ₹630.59 million and trade receivables of ₹326.77 million and a decrease in vehicle floor plan of ₹595.41 million, which were partially offset by increase in trade payables of ₹478.61 million and other liabilities of ₹375.78 million. Our cash generated from operations was ₹430.23 million, adjusted by direct taxes paid (net) of ₹2.59 million.

We generated ₹2,096.60 million net cash from operating activities during Fiscal 2020. While our restated loss before tax was ₹246.42 million, we had an operating profit before working capital changes of ₹805.14 million, primarily due to adjustments for depreciation and amortisation expense of ₹629.52 million and finance costs of ₹448.85 million, which were partially offset by interest income of ₹35.58 million and sundry balances written back (net) of ₹39.20 million. Our adjustments for working capital changes for Fiscal 2020 primarily consisted of a decrease in inventories of ₹1,140.34 million and trade receivables of ₹540.35 million, which were partially offset by a decrease in vehicle floor plan of ₹501.06 million and a decrease in trade payables of ₹106.68 million. Our cash generated from operations was ₹2,128.53 million, adjusted by direct taxes paid (net) of ₹31.93 million.

We generated ₹548.85 million net cash from operating activities during Fiscal 2019. While our restated loss before tax was ₹175.52 million, we had an operating profit before working capital changes of ₹934.81 million, primarily due to

adjustments for depreciation and amortisation expense of ₹534.16 million and finance costs of ₹527.63 million. Our adjustments for working capital changes for Fiscal 2019 primarily consisted of increase in trade receivables of ₹195.11 million and inventories of ₹151.01 million and a decrease in other liabilities of ₹72.14 million, which were partially offset by an increase in trade payables of ₹135.62 million. Our cash generated from operations was ₹692.53 million, adjusted by direct taxes paid (net) of ₹143.68 million.

#### ***Cash flows used in investing activities***

Net cash used in investing activities was ₹111.29 million for the six-month period ended September 30, 2021, primarily on account of ₹246.58 million used for purchase of property, plant and equipment, intangible assets, including movement in capital work-in-progress, capital creditors, capital advances and intangible assets under development, ₹42.40 million deposits with bank, which was partially offset by the net proceeds from inter-corporate deposits of ₹167.22 million.

Net cash used in investing activities was ₹220.28 million during Fiscal 2021, primarily on account of ₹148.03 million used for purchase of property, plant and equipment, intangible assets, including movement in capital work-in-progress, capital creditors, capital advances and intangible assets under development and inter-corporate deposits (net) given of ₹110.74 million, which was partially offset by interest received of ₹41.81 million.

Net cash used in investing activities was ₹659.13 million during Fiscal 2020, primarily on account inter-corporate deposits (net) given of ₹379.17 million, ₹224.13 million used for purchase of property, plant and equipment intangible assets, including movement in capital work-in-progress, capital creditors, capital advances and intangible assets under development and ₹102.49 million used for the purchase of investments, which was partially offset by the proceeds from sale of property, plant and equipment of ₹41.32 million.

Net cash used in investing activities was ₹379.38 million during Fiscal 2019, primarily on account of ₹359.23 million used for purchase of property, plant and equipment intangible assets, including movement in capital work-in-progress, capital creditors, capital advances and intangible assets under development and inter-corporate deposits (net) given of ₹55.26 million, which was partially offset by proceeds from sale of property, plant and equipment of ₹30.64 million.

#### ***Cash flows generated from / (used in) financing activities***

Net cash generated from financing activities for the six-month period ended September 30, 2021 amounted to ₹365.38 million, which primarily consists of net proceeds from short-term borrowings of ₹712.98 million and proceeds from long-term borrowings of ₹50.00 million, partially offset by the repayment of lease liabilities of ₹185.51 million and finance costs paid of ₹180.63 million.

Net cash used in financing activities during Fiscal 2021 amounted to ₹334.03 million, which primarily consists of finance costs paid of ₹382.85 million, repayment of long-term borrowings of ₹309.61 million and repayment of lease liabilities of ₹241.93 million, which were partially offset by net proceeds from short-term borrowings of ₹321.47 million and proceeds from long-term borrowings of ₹278.89 million.

Net cash used in financing activities during Fiscal 2020 amounted to ₹1,482.90 million, which primarily consists of net repayment of short-term borrowings of ₹761.61 million, finance costs paid of ₹457.62 million, repayment of long-term borrowings of ₹383.44 million and repayment of lease liabilities of ₹317.66 million, which were partially offset by proceeds from long-term borrowings of ₹437.43 million.

Net cash used in financing activities during Fiscal 2019 amounted to ₹275.63 million, which primarily consisted of finance costs paid of ₹530.41 million, repayment of long-term borrowings of ₹312.46 million and repayment of lease liabilities of ₹243.77 million, which were partially offset by proceeds from long-term borrowings of ₹470.90 million and net proceeds from short-term borrowings of ₹359.09 million.

#### ***Capital Commitments***

As at September 30, 2021 and March 31, 2021, the estimated amount of contracts remaining to be executed on capital account and not provided for (net of advances) was ₹4.43 million and ₹58.90 million, respectively.

#### ***Lease Liabilities***

We have entered into various lease contracts for our showrooms, workshop premises, plant and equipment and stockyards used in its operations. Leases of the showrooms, workshop premises, plant and equipment and stockyards generally have

lease terms between 2 to 10 years.

The following table sets forth a summary of the maturity profile of our lease liabilities as of September 30, 2021, March 31, 2021, March 31, 2020 and March 31, 2019:

(₹ in millions)

Particulars	Carrying Amount	Up to 1 year	1 – 5 years	More than 5 years	Total undiscounted cashflow
As at September 30, 2021	1,293.78	424.64	957.01	173.56	1,555.21
As at March 31, 2021	1,359.69	429.59	1,010.35	218.72	1,658.66
As at March 31, 2020	1,471.51	348.32	1,195.87	297.51	1,841.70
As at March 31, 2019	1,586.05	416.17	1,187.33	412.44	2,015.94

### Capital Expenditure

We invest capital in our business to maintain, upgrade and modernize our existing office, showrooms and service operations and to purchase furniture and fixtures, office equipment, motor vehicles and intangible assets. We also deploy capital opportunistically to complete acquisitions or investments and/or to build new facilities for new dealership locations. Capital expenditure will vary from year to year depending upon a number of factors, including the need to replace equipment, requirements from OEMs to upgrade or build new the facilities and the timing of certain projects, such as acquisitions and investments in new technologies.

For the six-month period ended September 30, 2021, we added intangible assets of ₹15.00 million, primarily for the customer relationship database towards acquisition of new location from existing dealer, and property, plant and equipment of ₹207.08 million, primarily for purchases of owned vehicles, plant and equipment, upgrading of existing facilities and acquisition of new showroom/workshop from existing dealer. For Fiscal 2021, we added property, plant and equipment of ₹110.64 million, primarily for purchase of plant and equipment, upgradation of existing facilities and purchase of vehicles. For Fiscal 2020, we added intangible assets of ₹0.44 million, primarily for purchase of software, and property, plant and equipment of ₹192.25 million, primarily for purchases of owned vehicles, plant and equipment and upgrading of existing facilities. For Fiscal 2019, we added intangible assets of ₹65.53 million, primarily for capitalization of software and non-compete fees for acquisition of new dealer and property, plant and equipment of ₹1,183.96 million, primarily for acquisition of property, plant and equipment pursuant to the Schemes of Arrangement, purchase of building, owned vehicles and upgrading of existing facilities.

The following table summarizes our capital expenditure for the six months ended September 30, 2021, Fiscal 2021, Fiscal 2020 and Fiscal 2019:

(₹ in millions)

Particulars	For the six months ended September 30, 2021	For the year ended March 31,		
		2021	2020	2019
Change in Capital Work-in-Progress	17.60	6.43	0.33	-
Leasehold Improvements	41.87	43.59	46.20	333.62
Electrical Installations	16.28	4.52	8.49	55.54
Plant and Equipment	27.15	22.07	11.56	183.63
Computers	3.60	3.48	6.21	23.45
Furniture and Fixtures	31.57	10.31	16.77	139.04
Office Equipment	6.46	6.68	9.48	64.65
Vehicles	80.15	19.99	91.80	66.88
Buildings	-	-	1.74	317.15
Computer Software	-	0.05	0.44	40.03
Customer Relationship	15.00	-	-	-
Non-Compete Fees	-	-	-	25.50
Change in Intangible assets under development	0.11	2.55	2.03	4.38
<b>Total Capital Expenditure</b>	<b>239.79</b>	<b>119.67</b>	<b>195.05</b>	<b>1,253.87</b>

The above capital expenditures were primarily financed by internally generated resources and long-term and short-term borrowings.

### Contingent Liabilities and Commitments

Contingent liabilities and commitments, to the extent not provided for, as of September 30, 2021, March 31, 2021, 2020 and 2019, as determined in accordance with Ind AS 37, are described below.

(₹ in millions)

Contingent liabilities	As at September 30, 2021	As at March 31,		
		2021	2020	2019
Matters with GST authorities	21.96	19.75	-	-
Matters with service tax authorities	217.24	217.24	212.00	-
Matters with income tax authorities	1.30	3.53	3.53	-
Matters with VAT authorities	6.04	6.04	2.91	2.91
Matters with local authorities	21.45	-	-	-
Corporate guarantees outstanding	1,875.33	1,524.47	2,629.50	2,629.50
<b>Total</b>	<b>2,143.32</b>	<b>1,771.03</b>	<b>2,847.94</b>	<b>2,632.41</b>

For details, see “Restated Consolidated Financial Information- Notes to Restated Consolidated Financial Information – Note 37 – Contingent Liabilities and Commitments” on page 245.

### Financial Indebtedness

The following table sets forth our secured and unsecured debt position as of September 30, 2021 and March 31, 2021.

(₹ in millions)

Indebtedness	As of September 30, 2021	As of March 31, 2021
<b>Short Term</b>		
<b>Secured Borrowings, comprising of:</b>		
Bank working capital loans	582.39	401.87
Other working capital loans	1,071.61	518.53
Current maturities of non-current borrowings	130.51	77.45
<b>Secured Borrowings</b>	<b>1,784.51</b>	<b>997.85</b>
<b>Unsecured Borrowings, comprising of:</b>		
Bank working capital loans	115.64	24.31
Other loans	411.26	536.60
Loans from related parties	57.88	44.50
<b>Unsecured Borrowings</b>	<b>584.78</b>	<b>605.41</b>
<b>Long Term</b>		
<b>Secured Borrowings, comprising of:</b>		
Bank term loans	47.57	38.83
Other term loans	320.55	320.79
Bank vehicle loans	44.67	54.08
(Less: Current maturities of non-current borrowings)	(130.51)	(77.45)
<b>Secured Borrowings</b>	<b>282.28</b>	<b>336.25</b>
<b>Unsecured Borrowings, comprising of:</b>		
Other loans	50.00	-
Loans from related parties	134.60	151.40
<b>Unsecured Borrowings</b>	<b>184.60</b>	<b>151.40</b>
<b>Vehicle Floor Plan Payable</b>	<b>1,252.26</b>	<b>1,183.50</b>
<b>Total Indebtedness</b>	<b>4,088.43</b>	<b>3,274.41</b>

## Quantitative and Qualitative Disclosures about Market Risk

Our financial liabilities comprise mainly of borrowings, lease liabilities, vehicle floor plan, trade payables and other financial liabilities. Our financial assets comprise mainly of investments, cash and cash equivalents, other balances with banks, loans given, trade receivables and other financial assets.

Our business activities expose us to a variety of financial risks, namely market risk, credit risk and liquidity risk. Our senior management has the overall responsibility for establishing and governing our risk management framework and for developing and monitoring our risk management policies. Our risk management policies are established to identify and analyze the risks faced by us, set and monitor appropriate risk limits and controls, periodically review the changes in market conditions and reflect the changes in the policy accordingly. The key risks and mitigating actions are also placed before the Board. Internal audit undertakes both regular and ad hoc reviews of risk management controls and procedures, the results of which are reported to the Board. For further information on our financial instruments, see “*Restated Consolidated Financial Information – Notes to Restated Consolidated Financial Information – Note 36 – Financial Risk Management*” on page 244.

Market risk is the risk that the fair value or future cash flows of a financial instrument will fluctuate because of changes in market prices. Market risk comprises three types of risk: interest rate risk, currency risk and other price risk. We do not have any outstanding balance in foreign currencies and hence we are not exposed to foreign currency risk. Financial instruments affected by market risk include loans and borrowings, deposits and investments. We manage market risk through a treasury department, which evaluates and exercises control over the entire process of market risk management.

### Interest Rate Risk

Interest rate risk is the risk that the future cash flow with respect to interest payments on borrowing will fluctuate because of change in market interest rates. Interest rate changes do not significantly affect short-term borrowings and vehicle floor plan. Therefore, our exposure to the risk of changes in market interest rates relates primarily to our long-term debt obligations with floating interest rates.

### Liquidity Risk

Liquidity risk is defined as the risk that we will not be able to settle or meet our obligations on time, or at a reasonable price. The objective of liquidity risk management is to maintain sufficient liquidity and ensure that funds are available for use as per requirements. We generate cash flows from operations to meet our financial obligations, maintain adequate liquid assets in the form of cash and cash equivalents and have undrawn short-term line of credits from banks to ensure necessary liquidity. We closely monitor our liquidity position and deploy a robust cash management system.

As at September 30, 2021, the Group’s current liabilities exceeded its current assets by ₹221.83 million, which is mainly due to the inclusion of the current portion of lease liabilities of ₹343.53 million and current portion of contract liabilities pertaining to advance received towards labour portion of annual maintenance contract of ₹144.07 million. The said deficit is expected to be met by the cash to be generated from the operations over the next financial year. Working capital limit of the Group is also expected to remain the same over the next financial year and hence the management believes that the Group will be able to meet its financial obligations during the next one year.

The table below sets out the maturity analysis of our financial liabilities based on the contractually agreed undiscounted cash flows along with its carrying value as at the respective balance sheet date:

(₹ in millions)

	Carrying amount	Less than 1 year	1 – 5 years	More than 5 years	Total undiscounted cashflow
<b>As at September 30, 2021</b>					
Borrowings	2,836.17	2,369.29	399.48	67.40	<b>2,836.17</b>
Lease liabilities	1,293.78	424.64	957.01	173.56	<b>1,555.21</b>
Vehicle floor plan payable	1,252.26	1,252.26	-	-	<b>1,252.26</b>
Trade payables	1,057.78	1,057.78	-	-	<b>1,057.78</b>
Other financial liabilities	57.25	57.25	-	-	<b>57.25</b>
<b>Total</b>	<b>6,497.24</b>	<b>5,161.22</b>	<b>1,356.49</b>	<b>240.96</b>	<b>6,758.67</b>

	Carrying amount	Less than 1 year	1 – 5 years	More than 5 years	Total undiscounted cashflow
<b>As at March 31, 2021</b>					
Borrowings	2,090.91	1,603.24	425.98	61.69	<b>2,090.91</b>
Lease liabilities	1,359.69	429.59	1,010.35	218.72	<b>1,658.66</b>
Vehicle floor plan payable	1,183.50	1,183.50	-	-	<b>1,183.50</b>
Trade payables	1,002.39	1,002.39	-	-	<b>1,002.39</b>
Other financial liabilities	49.76	49.76	-	-	<b>49.76</b>
<b>Total</b>	<b>5,686.25</b>	<b>4,268.48</b>	<b>1,436.33</b>	<b>280.41</b>	<b>5,985.22</b>
<b>As at March 31, 2020</b>					
Borrowings	1,800.17	1,518.29	179.18	102.70	<b>1,800.17</b>
Lease liabilities	1,471.51	348.32	1,195.87	297.51	<b>1,841.70</b>
Vehicle floor plan payable	1,778.91	1,778.91	-	-	<b>1,778.91</b>
Trade payables	556.73	556.73	-	-	<b>556.73</b>
Other financial liabilities	70.18	70.18	-	-	<b>70.18</b>
<b>Total</b>	<b>5,677.50</b>	<b>4,272.43</b>	<b>1,375.05</b>	<b>400.21</b>	<b>6,047.69</b>
<b>As at March 31, 2019</b>					
Borrowings	2,507.79	2,083.02	300.38	124.39	<b>2,507.79</b>
Lease liabilities	1,586.05	416.17	1,187.33	412.44	<b>2,015.94</b>
Vehicle floor plan payable	2,279.97	2,279.97	-	-	<b>2,279.97</b>
Trade payables	702.60	702.60	-	-	<b>702.60</b>
Other financial liabilities	104.12	104.12	-	-	<b>104.12</b>
<b>Total</b>	<b>7,180.53</b>	<b>5,585.88</b>	<b>1,487.71</b>	<b>536.83</b>	<b>7,610.42</b>

### **Credit Risk**

Credit risk is the risk that counterparty will not meet its obligations under a financial instrument or customer contract, leading to a financial loss. The credit risk for us primarily arises from credit exposures to trade receivables, loans given, deposits with landlords for properties taken on leases and other receivables including balances with banks.

Trade and other receivables: Our business is predominantly through credit card, cash collections and insurance companies, hence the credit risk on such transactions are minimal. We have adopted a policy of dealing with only creditworthy counterparties in case of institutional customers; the credit risk exposure for institutional customers is managed by us by credit worthiness checks. All trade receivables are also reviewed and assessed for default on a regular basis. Further, trade and other receivables consists of a large number of customers; hence, we are not exposed to concentration risks. In relation to credit risk arising from commercial transactions, necessary provisions are recognized for trade receivables when objective evidence exists that we will be unable to recover all the outstanding amounts in accordance with the original contractual conditions of the receivables. For further information on our trade receivables, see “*Restated Consolidated Financial Information – Notes to Restated Consolidated Financial Information – Note 14 – Trade Receivables*” on page 229.

We also carry credit risk on lease deposits with landlords for properties taken on leases, for which agreements are signed and property possessions timely taken for its operations. The risk relating to refunds after shut down of premises is managed through successful negotiations or appropriate legal actions, where necessary.

Credit risk arising from cash and cash equivalent and other balances with bank is limited as the counterparties are recognized banks. See “*Restated Consolidated Financial Information – Notes to Restated Consolidated Financial Information – Note 36.3 – Credit Risk*” on page 244.

### **Reservations, Qualifications and Adverse Remarks Included in Financial Statements**

There have been no reservations or qualifications or adverse remarks of our Statutory Auditors in the last three fiscal years and for the six-month period ended September 30, 2021.

### **Off-Balance Sheet Arrangements**

We do not have any off-balance sheet arrangements, derivative instruments or other relationships with other entities that would have been established for the purpose of facilitating off-balance sheet arrangements.

### **Related Party Transactions**

We enter into various transactions with related parties. For further information see “*Restated Consolidated Financial Information – Notes to Restated Consolidated Financial Information – Note 44 – Related Party Transactions*” on page 251.

### **Significant Economic Changes**

Other than as described above, to the knowledge of our management, there are no other significant economic changes that materially affect or are likely to affect income from continuing operations.

### **Unusual or Infrequent Events of Transactions**

Except as described in this Draft Red Herring Prospectus, there have been no other events or transactions that, to our knowledge, may be described as “unusual” or “infrequent”.

### **Known Trends or Uncertainties**

Our business has been affected and we expect will continue to be affected by the trends identified above in the heading titled “*Principal Factors Affecting Our Financial Position and Results of Operations*” and the uncertainties described in the section titled “*Risk Factors*” beginning on page 28. To our knowledge, except as described or anticipated in this Draft Red Herring Prospectus, there are no known factors which we expect will have a material adverse impact on our revenues or income from continuing operations.

### **Future Relationship Between Cost and Income**

Other than as described elsewhere in this Draft Red Herring Prospectus, including disclosure regarding the impact of COVID-19 on our operations, to the knowledge of our management, there are no known factors that might affect the future relationship between costs and revenues.

### **Significant Developments after September 30, 2021 that may affect our future results of operations**

Except as stated below and elsewhere in this Draft Red Herring Prospectus, no circumstances have arisen since the date of the Restated Consolidated Financial Information as disclosed in this Draft Red Herring Prospectus which materially and adversely affect or are likely to affect our operations or profitability, the value of our assets or our ability to pay our material liabilities within the next twelve months.

### **Change to Agency Model for Mercedes-Benz**

For details regarding the change and conversion of our relationship with Mercedes-Benz from a dealership to an agency model and its expected effects on our operations, profitability and assets and liabilities, see the subsection “ – *Principal Factors Affecting our Results of Operations – Change to Agency Model for Mercedes-Benz*” on page 276.

### **Employee Stock Option Plan (ESOP)**

Pursuant to resolutions of our Board of Directors dated October 28, 2021 and January 11, 2022, our Company has granted and issued 31,000 (of face value ₹10) and 12,000 (of face value ₹5) stock options, respectively, under the ESOP Scheme.

### **Acquisition of servicing business of Shaman Wheels Private Limited**

Pursuant to the business transfer agreement dated September 18, 2021 amongst us, Shaman Wheels Private Limited and their promoters, we have acquired the business of servicing Mercedes-Benz vehicles (including maintenance, repairs and warranty work/services through its network of identified four facilities) from Shaman Wheels Private Limited (the “Business Undertaking”) with effect from October 1, 2021. The total purchase consideration of the said transaction payable by us will be no less than ₹350.00 million and no more than ₹700.00 million, subject to any downward adjustment that may be required as a result of COVID-19-related lockdowns as per the terms of the business transfer agreement. The final determination will be based on the performance of the Business Undertaking over the next six months starting from

October 1, 2021. We expect to complete the payment of the purchase consideration in the first quarter of Fiscal 2023. The total purchase consideration for the acquisition of the Business Undertaking will be financed through internal accruals.

**Split of face value of equity shares from ₹10 to ₹5**

Pursuant to a resolution passed by the shareholders in the extra-ordinary general meeting held on November 10, 2021, our Company has sub-divided its equity shares, such that 18,312,810 equity shares of ₹10 each, aggregating to ₹183,128,100, were sub-divided as 36,625,620 Equity Shares of ₹5 each, aggregating to ₹183,128,100.



## FINANCIAL INDEBTEDNESS

For details regarding the borrowing powers of our Board, see “*Our Management-Borrowing Powers*” on page 184. Our Company and Subsidiaries avail credit facilities in the ordinary course of their business for the purposes of meeting business requirements. These credit facilities include *inter alia*, term loans, inventory fundings, trade advance and vehicle loans.

The details of aggregate indebtedness of our Company and Subsidiaries as on November 30, 2021, is set forth below:

*(in ₹ million, unless otherwise stated)*

Category of borrowing	Sanctioned Amount	Outstanding amount as on November 30, 2021
<b>Secured</b>		
Term loans	580.01**	461.56
Working capital facilities		
- Fund based	3,738.70**	1,943.13
- Non-fund based	473.60	466.10
<b>Unsecured</b>	655.00	388.24
<b>Total</b>	<b>5,447.31</b>	<b>3,259.03</b>

\* As certified by Manubhai & Shah LLP, Chartered Accountants, pursuant to their certificate dated January 18, 2022.

\*\* Includes term loan of ₹165.10 million and fund-based working capital facilities of ₹866.00 million as per sanction letter dated December 1, 2021.

### Principal terms of the borrowings currently availed by our Company and Subsidiaries:

Brief details of the terms of our various borrowing arrangements are provided below and there may be similar/ additional terms, conditions and requirements under the borrowing arrangements entered into by our Company and Subsidiaries with its lenders:

1. **Interest:** The interest rate payable for the facilities availed by the Company and its subsidiaries typically ranges between 6.55% to 11.75%. The interest rate payable for some of the facilities is linked to MCLR or benchmark rate of the respective lenders.
2. **Tenor:** Typically, the tenor of the facilities availed by the Company and the Subsidiaries ranges between 30 days to 60 months, while some of them are repayable on demand. The tenor for trade advance facilities varies between 30 days for every tranche to 12 months.
3. **Security:** In terms of our secured borrowings, we are required to, *inter alia*:
  - (a) Furnish personal guarantees from our Promoter, Sanjay Karsandas Thakker, and Ami Sanjay Thakker, a member of our Promoter Group;
  - (b) Create charge on immovable assets by way of mortgage;
  - (c) Create charge on movable assets, stock, spares, book debts.

Further, our Company has extended guarantees in relation to certain borrowings of our Subsidiaries.

4. **Re-payment:** Typically, the facilities availed by the Company and Subsidiaries are repayable within 30 days to 24 months. The repayment of some facilities is subject to the repayment schedules provided by the respective lenders. Few facilities are typically repayable on pay as sold basis, while others are repayable on demand. The working capital loans are repayable (i) in instalments basis the conditions elucidated in the agreements with principal moratorium applicable in certain cases; and (ii) on pay as sold basis.
5. **Pre-payment:** The facilities availed by the Company and the Subsidiaries have pre-payment penalty applicable, that typically ranges between 3% to 5% of the amount prepaid. The pre-payment penalty applicable to one of the facilities is 5.21% plus GST on the outstanding principal amount, while no prepayment-penalty is payable for the other facilities.

6. **Restrictive Covenants:** The borrowing arrangements entered into by our Company and Subsidiaries with the Lenders entail certain restrictive conditions and covenants restricting certain corporate actions, and we are required to take the prior approval of / intimation to the Lender before carrying out such activities.
- (i) change the general nature of its business or undertake any expansion or invest in any other entity;
  - (ii) the borrower shall not change its company name or trade name;
  - (iii) make any amendments to its constitutional documents;
  - (iv) conclude any fresh borrowing arrangement either secured or unsecured with any other bank or financial institutions, borrower or otherwise, not create any further charge over their fixed assets;
  - (v) not to permit any change in the ownership or control of the borrower which may change the effective beneficial ownership or control of the borrower and also not to effect any material change in the management of the business, not to make any amendments in the borrower's memorandum and articles without prior-written consent of the bank;
  - (vi) effect any change in the capital structure of the borrower;
  - (vii) create any charge, lien or encumbrance over its properties or any part thereof, in favour of any financial institution, bank, company or for more persons;
  - (viii) changes in shareholding pattern/ profit sharing ratio or changes in constitution if any;
  - (ix) the happening of an event likely to have a substantial effect or adverse effect on their profit or business;
  - (x) undertake any new project, implement any scheme of expansion/diversification or capital expenditure or acquired fixed assets.
7. **Events of Default:** The borrowing arrangements entered into by our Company and Subsidiaries with the Lender contains certain instances, occurrence of which may result into 'event of default', including:
- (a) failure to make payment of any principal amount or interest on the relevant due dates;
  - (b) failure to create and perfect security as stipulated;
  - (c) any notice or action in relation to actual /threatened liquidation /dissolution /bankruptcy /insolvency /seizing to carry on business of any borrower/guarantor (voluntary or involuntary);
  - (d) any information provided by any borrower or guarantor is incorrect or untrue;
  - (e) failure to observe or comply with the terms and conditions of the borrowing arrangement;
  - (f) usage of proceeds for a purpose other than that provided in the agreement;
  - (g) inability of the borrower to pay debts to any person or any steps taken by any person accelerating the payment obligation of the borrower or declaration by any person of an event of default under their respective arrangements with the borrower or any event which under any law statute rule ordinance et cetera which would have the effect of suspending or waiving all or any of the creditors generally, against the borrower or in respect of any contract or agreement concerning the borrower
  - (h) in case our Company ceases or threatens to cease to carry on its business; and
  - (i) in case any step is taken against our Company for dissolution, winding up, liquidation and/or insolvency, including the appointment of a receiver.

The details above are indicative and there may be similar additional instances that may amount to an event of default under the borrowing arrangements entered into between our Company and Subsidiaries with its respective lenders.

Given the nature of these borrowings and the terms of prepayment, the aggregate outstanding borrowing amounts may vary from time to time. In addition to the above, our Company and Subsidiaries may, from time to time, enter into re-financing arrangements and draw down funds thereunder, prior to the filing of the Red Herring Prospectus.

## SECTION VII – LEGAL AND OTHER INFORMATION

### OUTSTANDING LITIGATION AND OTHER MATERIAL DEVELOPMENTS

*Except as stated below, there are no outstanding (i) criminal proceedings involving our Company, Subsidiaries, Directors, or Promoter (“**Relevant Parties**”); (ii) actions by statutory or regulatory authorities involving the Relevant Parties; (iii) claims relating to direct and indirect taxes involving the Relevant Parties; and (iv) litigation involving Relevant Parties (other than proceedings covered under (i) to (iii) above) which have been determined to be “material” pursuant to the Materiality Policy.*

*In accordance with the Materiality Policy, all outstanding litigation (other than outstanding criminal proceedings, actions by statutory or regulatory authorities and claims relating to direct and indirect taxes involving the Relevant Parties wherein (i) the aggregate monetary claim made by or against the Relevant Parties (individually or in the aggregate), in any such pending litigation/arbitration, is equal to or in excess of an amount equivalent of 2% of the Company’s consolidated profit after tax for the most recently completed fiscal year, as per the restated consolidated financial statements of the Company disclosed in the relevant Offer Document; or (ii) any such litigation wherein a monetary liability is not quantifiable, or which does not fulfil the threshold specified in (i) above, but the outcome of which could, nonetheless, have a material adverse effect on the business, operations, performance, prospects, financial position or reputation of our Company have been considered “material” and accordingly have been disclosed in this Draft Red Herring Prospectus.*

*The consolidated profit after tax of our Company for Fiscal 2021 was ₹111.48 million while the consolidated total income of our Company for Fiscal 2021 was ₹19,663.43 million. Accordingly, all such outstanding litigation proceedings where the aggregate monetary claim made by or against the Relevant Parties (individually or in aggregate), in any such outstanding litigation or arbitration proceeding is equal to or in excess of ₹2.23 million (being 2% of our consolidated profit after tax in Fiscal 2021), have been disclosed in this Draft Red Herring Prospectus.*

*Further, there are no: (i) disciplinary actions (including penalties) imposed by SEBI or a recognized stock exchange against our Promoter in the last five Fiscals immediately preceding the date of this Draft Red Herring Prospectus, including any outstanding action; and (ii) outstanding litigation involving the Group Companies, which may have a material impact on our Company.*

*For the purposes of the above, pre-litigation notices received by the Relevant Parties or the Group Companies from third parties (excluding notices issued by statutory or regulatory authorities or notices threatening criminal action) have not and shall not, unless otherwise decided by our Board, be considered “material” until such time that the Relevant Parties or Group Companies are impleaded as a defendant before any judicial or arbitral forum.*

*Further, in accordance with the Materiality Policy, our Company has considered such creditors to be ‘material’, to whom the amount due is equal to or in excess of 5% of the consolidated trade payables of our Company as of September 30, 2021. The consolidated trade payables of our Company as on September 30, 2021 was ₹1,057.78 million. Accordingly, a creditor has been considered ‘material’ if the amount due to such creditor individually exceeds ₹ 52.89 million as on September 30, 2021.*

*Unless stated to the contrary, the information provided below is as of the date of this Draft Red Herring Prospectus. All terms defined in a particular litigation disclosure below are for that particular litigation only.*

#### LITIGATION INVOLVING OUR COMPANY

##### **(a) Outstanding litigation proceedings against our Company**

###### **(i) Criminal proceedings**

*There are no outstanding criminal proceedings filed against our Company, as on the date of this Draft Red Herring Prospectus.*

###### **(ii) Actions by regulatory or statutory authorities**

*As on the date of this Draft Red Herring Prospectus, there are no pending actions by regulatory or statutory authorities against our Company.*

**(iii) Other material pending proceedings**

As on the date of this Draft Red Herring Prospectus, except as stated below, there are no other pending proceedings filed against our Company which have been considered material by our Company in accordance with the Materiality Policy.

1. Himanshu Poojara (“**Complainant**”) filed a complaint (“**Complaint**”) before the State Consumer Disputes Redressal Commission, Maharashtra (“**State Commission**”) against the then managing director and chief executive officer of our Company and others. In relation to the vehicle which the Complainant had purchased from our Company, the Complainant alleged that there had been deficiency in service and unfair trade practices on the part of our Company. The Complainant alleged that due problems in his vehicle, he had brought his vehicle to a service centre of our Company for servicing. However, the problem could not be solved and the Complainant received the vehicle in a dismantled condition. The Complainant has prayed for replacement of the vehicle or in the alternative, has sought compensation aggregating to ₹ 5.30 million along with interest from our Company, for mental agony and deficient services. The matter is currently pending.
2. Digvijaysinh Jadeja (“**Complainant**”) filed a complaint (“**Complaint**”) before the State Consumer Disputes Redressal Commission, Gujarat (“**State Commission**”) against our Company and others. The Complainant met with an accident on his way from Rajkot to Gandhinagar. In relation to a vehicle which the Complainant had purchased from our Company, the Complainant alleged deficiency in service and unfair trade practices on the part of our Company. The Complainant has sought compensation aggregating to ₹ 11.20 million along with interest from our Company on account of deficiency in service, mental harassment, physical injuries and raised concerns about the safety measure in the vehicle. Our Company has submitted its written statement refuting the allegations made by the Complainant. Further, our Company has submitted that the Complainant has recovered the full value of the vehicle and disposed of the salvage sale of the vehicle by the insurance company and has sought for the Complaint to be dismissed. The matter is currently pending.
3. Natvarlal Zinabhai Patel (“**Complainant**”) filed a complaint (“**Complaint**”) before the Gujarat Consumer Disputes Redressal Commission, Ahmedabad (“**State Commission**”) against our Company and others. In relation to a vehicle which the Complainant had purchased from our Company, the Complainant alleged *inter alia* negligence, deficiency in service and unfair trade practices. The Complainant argued that the oil leakage was a part of the manufacturing defect and the odometer of the vehicle purchased from our Company at the time of delivery showed 89 kilometres and not 00 kilometres. The Complainant sought compensation aggregating to ₹ 6.70 million along with interest. Our Company filed a written statement denying the allegations made by the Complainant and claimed that it had agreed to repair the oil leakage and further the reason for 89 kilometres mark in the odometer was because of the pre-delivery testing. Our Company *inter alia* prayed dismissal of the Complaint. The matter is currently pending.
4. Manojkumar Tanukumar Patel (“**Complainant**”) filed a complaint (“**Complaint**”) before the Consumer Dispute Redressal Forum, Ahmedabad, Rural (“**State Commission**”) against our Company. In relation to a vehicle which the Complainant had purchased from our Company, the Complainant has alleged deficiency in service and manufacturing defects in several components of the vehicle. The Complainant has *inter alia* prayed for the replacement of vehicle. Our Company has filed its written statement denying the allegations and has claimed that the Complaint is not maintainable due to non-joinder of necessary party i.e., the relevant OEM and has prayed for the dismissal of the Complaint. The Complainant has prayed for the defective parts of the vehicle to be replaced or in the alternative, has sought replacement of the vehicle. The matter is currently pending.
5. Mittal Bhavin Patel (“**Complainant**”) filed a complaint (“**Complaint**”) before the State Consumer Disputes Redressal Commission at Ahmedabad (“**State Commission**”) against our Company and Benchmark Cars, the tradename of our Company in Gujarat (“**Respondent**”). The Complainant alleged that the Respondents delivered a vehicle that was manufactured in the year 2015 instead of 2016 as mentioned in the car sale certificate. The Complainant has sought *inter alia* a replacement of the vehicle or in the alternative, compensation aggregating to ₹ 4.68 million along with interest. Pursuant to the Complaint, our Company filed a written statement denying all allegations and counter-alleging that the Complainant had tampered with the documents of regional transport office registration and insurance policy and prayed for dismissal of the Complaint for lack of cause of action. The matter is currently pending.
6. Manish Beohar (“**Complainant**”) filed a complaint (“**Complaint**”) before the National Consumer Disputes Redressal Commission, New Delhi against Benchmark Cars, a tradename of our Company in Gujarat and others. In relation to a vehicle which the Complainant had purchased from our Company, the Complainant alleged that

the vehicle failed to deploy the airbags during an accident which the Complainant met. The Complainant further alleged that our Company failed to acknowledge its liability and failed to render proper services after the accident that took place. The Complainant alleged deficiency of service, negligence and unfair trade practice on part of our Company. The compensation sought by the Complainant is ₹ 31.50 million along with interest for *inter alia* severe physical injuries and mental trauma. Our Company has submitted its written statement denying all allegations. The matter is currently pending.

7. CAMA Hotels Ltd (“**Plaintiff**”) filed a suit against Sanjay Karsandas Thakker (in the capacity of Director of our Company) and others (“**Defendant**”) before the City Civil Court Judge at Ahmedabad (“**Court**”). The Plaintiff was a dealer for Mercedes-Benz passenger cars for the State of Gujarat and Maharashtra. In relation to the vehicle which the Plaintiff purchased from our Company, the Plaintiff alleged that several vital components of the vehicle were of exceedingly low quality and that faulty designs led to prolonged hardship and difficulties for the Plaintiff. The Plaintiff further alleged deficiency of service, negligence and unfair trade practice on part of our Company. The Plaintiff has sought damages aggregating to ₹ 50.00 million along with interest from our Company on account of deficiency in service, mental harassment, physical injuries and raised concerns about the safety measure in the vehicle. Our Company has submitted its written statement, *inter alia* denying all allegations and counter alleged that the event did not arise in the jurisdiction of the Court and accordingly, prayed for dismissal of the Complaint. The matter is currently pending.
8. Lux Industries Limited (“**Complainant**”) filed a complaint (“**Complaint**”) against Benchmark Cars, a tradename of our Company in Gujarat, our Company and others before the State Consumer Disputes Redressal Commission, West Bengal (“**State Commission**”). The Complainant alleged deficiency in service and unfair trade practices on the part of Benchmark Cars and our Company. The Complainant had purchased two vehicles of the same model, however, at the time of the delivery, one of the vehicles did not have a global positioning system (GPS) navigation feature. The State Commission pursuant to its order dated August 13, 2018 (“**Order**”), held the Complaint as non-maintainable on the ground of the total claimed relief being beyond the pecuniary jurisdiction of the Commission and accordingly, directed the Complainant to approach the appropriate authority. The Complainant, aggrieved by the Order, has preferred an appeal before the National Consumer Disputes Redressal Commission seeking the Order to be quashed and the matter to be remanded back to the State Commission for disposal on merits. The matter is currently pending.

**(iv) Claims related to direct and indirect taxes**

*Except as mentioned below, there are no pending claims related to direct and indirect taxes against our Company as on the date of this Draft Red Herring Prospectus:*

*(in ₹ million)*

<b>Nature of proceeding</b>	<b>Number of proceedings outstanding</b>	<b>Amount involved*</b>
Direct tax	Nil	Nil
Indirect tax	8	97.85
<b>Total</b>	<b>8</b>	<b>97.85</b>

\* To the extent quantified.

**(b) Outstanding litigation proceedings by our Company**

**(i) Criminal proceedings**

As of the date of this Draft Red Herring Prospectus, there are four cases filed by our Company under the Negotiable Instruments Act, 1881 in relation to dishonour of cheques. The total amount involved in all these matters is ₹ 0.41 million. These matters are currently pending.

**(ii) Other material pending proceedings**

*As on the date of this Draft Red Herring Prospectus, there are no pending proceedings filed by our Company which have been considered material by our Company in accordance with the Materiality Policy.*

**LITIGATION INVOLVING OUR SUBSIDIARIES**

**(a) Outstanding litigation proceedings against our Subsidiaries**

**I. Landmark Cars (East) Private Limited (“LCEPL”)**

**(i) Criminal proceedings**

*As on the date of this Draft Red Herring Prospectus, except as stated below, there are no outstanding criminal proceedings filed against LCEPL.*

1. Kohinoor Steel Private Limited (“**Complainant**”) filed a complaint (“**Complaint**”) before the Court of the Chief Judicial Magistrate at Alipore (“**Court**”) against Intercraft Autocity Private Limited, Sanjay Karsandas Thakker (in the capacity of chairman of Intercraft Autocity Private Limited), and others. In relation to a vehicle which the Complainant had purchased from LCEPL, the Complainant alleged that the vehicle failed to deploy the airbags during an accident involving the managing director of the Complainant. The Complainant has prayed to the Court to take cognizance of the Complaint for commission of offences punishable under Section 405 read with Section 120B of the Indian Penal Code, 1860 and pass orders. The matter is currently pending.
2. Akashdeep Agarwal (“**Complainant**”), on behalf of Prapti Fashion Private Limited (“**Complainant Company**”) filed a complaint against LCEPL and others (“**Accused**”) before the Court of the Chief Metropolitan Magistrate, Calcutta. The Complainant has alleged that the Accused had sold him a vehicle for their wrongful gain and misappropriated an amount of ₹ 3.64 million. Further, the Complainant has alleged that the Accused had intended to commit cheating and criminal breach of trust as they repeatedly induced the Complainant to part with the money in the name of servicing of minor issues of the vehicle. LCEPL has denied all the allegations made by the Complainant. LCEPL *inter alia* alleged that the warranty period had expired, and the Complainant was obligated to pay for the repairing and replacement and maintenance of the vehicle and further submitted that Complainant damaged the car due to lack of maintenance and improper use and/or handling the vehicle. LCEPL prayed for the Complaint to be dismissed. The matter is currently pending.
3. Sourabh Dokania, a representative of Bharat Hitech (Cements) Private Limited (“**Complainant**”) filed a complaint (“**Complaint**”) against LCEPL and others (“**Accused**”) before the Court of the Chief Judicial Magistrate, Purulia, West Bengal (“**Magistrate**”). In relation to a vehicle which the Complainant had purchased from Benchmark Interkrafts, a tradename of our Company in West Bengal. The Complainant alleged that at one instance the tyre of the vehicle burst while riding causing physical injuries to the Complainant. Further, it was alleged that the vehicle delivered was not a brand new one and that the registration of the vehicle originally stood in name of Shanti Kumar Surana, one of the Accused in the Complaint (“**Allegations**”). The Magistrate pursuant to its order dated December 6, 2019 (“**Order**”) refused to issue charges against Shanti Kumar Surana, and issued directions against the other Accused. The Complainant being aggrieved by the Order, filed a criminal revision petition before the Sessions Court at Purulia for issuance of charges against Shanti Kumar Surana. However, the Sessions Court concurred with the Order and dismissed the criminal revision petition. The matter is currently pending. The Complainant has also filed a complaint before the District Consumer Disputes Redressal Forum, Kolkata. For further details, see “- *Outstanding litigation proceedings initiated against our Subsidiaries - Landmark Cars (East) Private Limited (“LCEPL”) – Other material pending proceedings*” on page 317.

**(ii) Actions by statutory or regulatory authorities**

*As on the date of this Draft Red Herring Prospectus, there are no pending actions initiated by any statutory or regulatory authority against LCEPL.*

**(iii) Other material pending proceedings**

*Except as disclosed below, as on the date of this Draft Red Herring Prospectus, there are no pending proceedings initiated against LCEPL, which have been considered material by our Company in accordance with the Materiality Policy.*

1. Parimala Mercantile Private Limited (“**Complainant**”) filed a complaint (“**Complaint**”) before the State Consumer Disputes Redressal Commission, West Bengal (“**State Commission**”) against LCEPL and others. The Complainant alleged that it had earlier requested LCEPL to provide a courtesy car, since its own vehicle was under repair with LCEPL. However, LCEPL rejected the request made by the Complainant, pursuant to which the Complainant had to hire another vehicle from outside. Additionally, the LCEPL refused to pay such hire charges to the Complainant. The Complainant has sought a compensation of ₹ 3.00 million and filed an interlocutory application. The State Commission pursuant to its order dated May 11, 2018 (“**Order**”) allowed the interlocutory application and *inter alia* directed LCEPL to provide a courtesy car to the Complainant. LCEPL being aggrieved by the Order, filed an appeal before the National Consumer Disputes Redressal Commission, New Delhi (“**National Commission**”). The National Commission pursuant to its order dated May 31, 2018, granted a stay on the Order. The matter is currently pending.

2. Universal Consortium of Engineers Private Limited (“**Complainant**”) filed a complaint (“**Complaint**”) before the State Consumer Disputes Redressal Commission, West Bengal (“**Commission**”), against LCEPL and others alleging deficiency in service and manufacturing defect in a vehicle which was sold by LCEPL. The Complainant alleged that it was facing consistent problems with the anti-lock braking system (ABS) of the vehicle, which was not rectified by LCEPL despite repeated services. The Complainant *inter alia* prayed for the replacement of the vehicle or in the alternative, refund of the cost of the defective vehicle along with interest. The Complainant simultaneously filed an interim application seeking repair of the vehicle during pendency of the Complaint. LCEPL refuted all the allegations made by the Complainant in the interim application on the grounds that it was not in existence at the time when the cause of action arose and that it is only a service provider and not the manufacturer. The State Commission pursuant to its order dated January 21, 2021 dismissed the interim application, as the Complainant had not made a sincere effort to establish its claims scientifically. The matter is currently pending.
3. Naveen Nayyar (“**Complainant**”) filed a complaint (“**Complaint**”) before the State Consumer Disputes Redressal Commission, West Bengal (“**State Commission**”), against LCEPL, Sanjay Karsandas Thakker, Paras Somani and others. In relation to a vehicle which the Complainant had purchased from LCEPL, the Complainant alleged that he has been facing problems with the vehicle since its purchase in 2009. The Complaint was filed alleging deficiency in service, inherent defect in the goods and unfair trade practices. The Complainant alleged that he had sent the vehicle for servicing multiple times and incurred huge costs in relation to the same. Pursuant to this Complaint, the Complainant *inter alia* claimed a compensation aggregating to ₹ 3.10 million and claimed a free of cost repair and service of the vehicle. LCEPL denied the allegations made by the Complainant in its written statement. The State Commission pursuant to its order dated August 16, 2019 (“**Order**”), directed LCEPL to *inter alia* make the repairs free of cost. Pursuant to the Order, LCEPL preferred an appeal before the National Consumer Disputes Redressal Commission, New Delhi (“**National Commission**”) alleging that the State Commission erred in partially allowing the Complaint as the same was not maintainable. The National Commission pursuant to its order dated September 29, 2019, granted a stay on the Order. The matter is currently pending.
4. Vijay Bothra (“**Complainant**”) filed a complaint (“**Complaint**”) before the State Consumer Disputes Redressal Commission, West Bengal (“**Commission**”), against the Managing Director of LCEPL and others (“**Respondents**”). The Complainant has alleged deficiency in service, defect of goods and unfair trade practices, on the part of the Respondents. The Complainant was travelling in the car sold by LCEPL, where he met with an unfortunate accident and suffered severe injuries due to non-deployment of the six airbags installed in the car at the time of accident. After the accident, the Complainant took the vehicle to LCEPL for repair, wherein LCEPL took the vehicle under its custody. Even though a lot of time elapsed, LCEPL did not deliver the vehicle back to the Complainant. Hence, the Complainant pursuant to an order from the Commission got back his vehicle. Whilst, collecting the vehicle from the custody of LCEPL, the Complainant noticed that there was deficiency in service and vehicle had a few components missing. The Complainant has *inter alia* prayed for compensation aggregating to ₹ 3.90 million from the Respondents. The matter is currently pending.
5. Suparna Bhaumik Sarkar (“**Complainant**”) filed a complaint (“**Complaint**”) before the State Consumer Disputes Redressal Commission, West Bengal (“**State Commission**”), against Benchmark Interkrafts, tradename of LCEPL in West Bengal and others. In relation to a vehicle which the Complainant had purchased from LCEPL, the Complainant alleged that there have been consistent rattling noises from different parts of the vehicle and the anti-lock braking system (ABS) of the vehicle provided was defective. The Complaint has been filed alleging gross deficiency in service and manufacturing defect. The Complainant sought damages worth ₹ 4.79 million from the Accused. Benchmark Interkrafts, tradename of LCEPL in West Bengal, pursuant to its written statement has submitted that the alleged fault and malfunction in the car was owing to the Complainant’s own default and neither was there any manufacturing defect in the vehicle nor any deficiency in services on the part of Benchmark Interkrafts, tradename of LCEPL in West Bengal. The matter is currently pending.
6. Bharat Hitech (Cements) Private Limited (“**Complainant**”) filed a complaint against LCEPL and others before the District Consumer Disputes Redressal Forum, Kolkata in relation to a vehicle which the Complainant purchased from Benchmark Interkrafts, a tradename of LCEPL in West Bengal (“**Complaint**”). The Complainant alleged that at one instance the tyre of the vehicle burst while riding causing physical injuries to the Complainant. Further, it was alleged that the vehicle delivered was not a brand new one and that the registration of the vehicle originally stood in name of Shanti Kumar Surana, one of the Accused in the Complaint (“**Allegations**”). The Complainant, *inter alia* in relation to the Allegations, prayed for the replacement of the vehicle or in the alternative, for a refund of the amount of ₹ 3.34 million along with interest, in addition to payment of compensation



aggregating to ₹ 8.50 million. LCEPL in its written response has challenged the maintainability of the Complaint on the ground of lack of pecuniary jurisdiction and further denied the Allegations. The matter is currently pending.

7. Exact Leather and Accessories (“**Complainant**”) filed a complaint (“**Complaint**”) before the State Consumer Disputes Redressal Commission, West Bengal (“**State Commission**”), against Benchmark Interkrafts, a tradename of LCEPL in West Bengal alleging *inter alia* deficiency in service and defect in goods and unfair trade practices. In relation to a vehicle which the Complainant had purchased from LCEPL, the Complainant has alleged that the vehicle met with an accident whilst in the custody of LCEPL due to the negligent act of the mechanic employed by LCEPL. The Complainant has claimed *inter alia* the replacement of vehicle or in the alternative, compensation aggregating to ₹ 2.24 million along with interest. LCEPL has submitted its written statement denying all allegations and counter alleged that the compensation claimed is highly disproportionate to the damage actually caused and accordingly, prayed for dismissal of the Complaint. The matter is currently pending.
8. KLR Agro Private Limited and another (“**Complainant**”) filed a complaint (“**Complaint**”) before the State Consumer Disputes Redressal Commission, Kolkata, West Bengal (“**State Commission**”) against Benchmark Interkrafts, tradename of LCEPL in West Bengal and others. The Complainant has alleged that all four tyres of the vehicles purchased from Benchmark Interkrafts, tradename of LCEPL in West Bengal, suffered a manufacturing defect and burst simultaneously when he was travelling along with his family. Accordingly, the Complainant has alleged severe negligence and inaction on the part of LCEPL and claimed compensation aggregating to ₹ 4.50 million along with interest. The matter is currently pending.

**(iv) Claims related to direct and indirect taxes**

*Except as mentioned below, there are no pending claims related to direct and indirect taxes against LCEPL as on the date of this Draft Red Herring Prospectus:*

<i>(in ₹ million)</i>		
Nature of proceeding	Number of proceedings outstanding	Amount involved*
Direct tax	Nil	Nil
Indirect tax	1	0.34
<b>Total</b>	<b>1</b>	<b>0.34</b>

\* To the extent quantified.

**II. Landmark Commercial Vehicles Private Limited (“LCVPL”)**

**(i) Criminal proceedings**

*As on the date of this Draft Red Herring Prospectus, there are no outstanding criminal proceedings filed against LCVPL.*

**(ii) Actions by statutory or regulatory authorities**

*As on the date of this Draft Red Herring Prospectus, there are no pending actions initiated by any statutory or regulatory authority against LCVPL*

**(iii) Other material pending proceedings**

*Except as disclosed below, as on the date of this Draft Red Herring Prospectus, there are no material pending proceedings initiated against LCVPL, which have been considered material by our Company in accordance with the Materiality Policy.*

1. Nirmitt Kanaiyalal Patel (“**Complainant**”) filed a complaint (“**Complaint**”) before the State Consumer Disputes Redressal Commission, Gujarat (“**State Commission**”) against LCVPL and others. The Complainant alleged that the vehicle purchased from LCVPL had multiple manufacturing defects at the time of delivery due to which the vehicle had undergone several rounds of repairing and maintenance. Further, the Complainant alleged that the issues with the gear-box persisted despite regular repairs and replacements. The State Commission pursuant to its order dated February 8, 2018, *inter alia* dismissed the Complaint on the ground that the Complainant could not prove the inherent manufacturing defects. Aggrieved by the Order, the Complainant preferred an appeal before the National Consumer Disputes Redressal Commission, New Delhi (“**National Commission**”). The Complainant has *inter alia* prayed for replacement of the vehicle or in the alternative, compensation aggregating to ₹2.50 million along with interest. The matter is currently pending.

**(iv) Claims related to direct and indirect taxes**

*There are no pending claims related to direct and indirect taxes against LCVPL as on the date of this Draft Red Herring Prospectus.*

**III. Landmark Lifestyle Cars Private Limited (“LLCPL”)**

**(i) Criminal proceedings**

*As on the date of this Draft Red Herring Prospectus, there are no outstanding criminal proceedings filed against LLCPL.*

**(ii) Actions by statutory or regulatory authorities**

*As on the date of this Draft Red Herring Prospectus, there are no pending actions initiated by any statutory or regulatory authority against LLCPL.*

**(iii) Other material pending proceedings**

*As on the date of this Draft Red Herring Prospectus, except as stated below, there are no other pending proceedings initiated against LLCPL, which have been considered material by our Company in accordance with the Materiality Policy.*

- (1) A claim petition (“**Petition**”) has been filed by Promila Singh and others (“**Complainant**”) against LLCPL and others (“**Respondent**”) before the Motor Accidents Claim Tribunal, Sonapat (“**Tribunal**”). Promila Singh’s husband succumbed to injuries after he was hit by the vehicle which was driven by Adhiraj Singh Chauhan in Gurugram. The Complainant alleged that Adhiraj Singh Chauhan was driving LLCPL’s vehicle in a rash and negligent manner while taking a test drive of the vehicle. The Complainant has claimed approximately ₹ 50.06 million from the Respondents. LLCPL pursuant to its response has denied the allegations made by the Complainant. The matter is currently pending.
- (2) Rupali P. Shivalkar (“**Complainant**”) filed a complaint (“**Complaint**”) before the District Consumer Dispute Redressal Forum, Dwarka (“**District Commission**”) against LLCPL. The Complainant alleged that she had given the custody of her vehicle to one of LLCPL’s workshops at Okhla for repair and servicing and was promised the delivery of the vehicle on the same day, however there was a delay in the delivery of the vehicle by LLCPL on several instances. The Complainant alleged that on February 27, 2021, she received a call from the employees of LLCPL wherein the Complainant was informed that her vehicle was stolen from the workshop and an e-FIR was lodged by the employees of LLCPL. The Complainant alleged that there had been negligence on the part of the employees of LLCPL and suspected the involvement of the employees of LLCPL in the alleged theft of the vehicle. The Complainant further alleged that by lodging the FIR, LLCPL had admitted negligence on their part. The Complainant *inter alia* prayed for LLCPL to pay ₹ 2.80 million as compensation for the stolen car, ₹ 0.50 million against mental harassment and agony and ₹ 0.50 million for inconvenience and actual conveyance charges. The matter is currently pending.
- (3) Prashant Parsurampurua (“**Complainant**”) filed a complaint (“**Complaint**”) against LLCPL and others, including Sanjay Karsandas Thakker, Rajiv Bal Vohra and Garima Misra (in their capacity as directors of LLCPL), before the District Consumer Dispute Redressal Commission, Mumbai, Maharashtra (“**District Commission**”). The Complainant had purchased a Jeep Compass which was repeatedly called for repairs, and hefty amounts were charged for replacing defective parts. The Complainant alleged that the vehicle purchased by him was of substandard quality and poor making. Further, he alleged LLCPL of adopting and indulging in unfair, malafide and restrictive trade practices for misguiding customers and duping/extorting money off them. The Complainant has sought a replacement of the vehicle or return of the purchase price of ₹ 2.02 million with interest along with compensation to the tune of ₹ 2.50 million with interest for mental agony and harassment. The Complaint is currently pending.
- (4) Makemytrip (India) Private Limited and another (“**Complainant**”) has filed a complaint (“**Complaint**”) against LLCPL and others (“**Opposite Parties**”) before the District Consumer Disputes Redressal Commission, Gurugram. (“**District Commission**”). The Complainant had purchased a vehicle, which was allegedly delivered to them without cleaning and proper inspection. It was further noticed that there were several problems in the vehicle, including cabin noises. The Complainant alleged that despite being assured of superlative services, the defects in his car were not rectified as of the date of the Complaint. The Complainant had sent a legal notice to

the Opposite Parties demanding timelines and relevant documents showcasing inspection. The Opposite Parties have failed to respond to the legal notice. The Complainant alleged deficiency in services and usage of unfair trade practices by the Opposite Parties. The Complainant has sought replacement of the car and compensation to the tune of ₹ 0.52 million on account of mental agony and harassment, and litigation expenses. The matter is currently pending.

**(iv) Claims related to direct and indirect taxes**

Except as mentioned below, there are no pending claims related to direct and indirect taxes against LLCPL as on the date of this Draft Red Herring Prospectus:

<i>(v) (in ₹ million)</i>		
Nature of proceeding	Number of proceedings outstanding	Amount involved*
Direct tax	Nil	Nil
Indirect tax	3	8.86
<b>Total</b>	<b>3</b>	<b>8.86</b>

**IV. Automark Motors Private Limited (“AMPL”)**

**(i) Criminal proceedings**

As on the date of this Draft Red Herring Prospectus, there are no outstanding criminal proceedings filed against AMPL.

**(ii) Actions by statutory or regulatory authorities**

Except as disclosed below, as on the date of this Draft Red Herring Prospectus, there are no pending actions initiated by any statutory or regulatory authority against AMPL.

- (1) The Member Secretary of the Commission for Air Quality Management in National Capital Region (“**Commission**”) and adjoining areas has by way of direction dated December 14, 2021 directed AMPL to immediately shut down its industrial operations at Okhla Industrial Estate, New Delhi under Section 12(2)(xi) of the Commission for Air Quality Management in National Capital Region and Adjoining Areas Act, 2021, until further orders. As per the directions issued by the Commission dated November 14, 2021 and November 16, 2021 (“**Directions**”), all industrial units which are connected to PNG/ cleaner fuels were required to operate only on PNG/ cleaner fuels, failing which these units shall be immediately closed down. Further, industrial units which did not have PNG/ cleaner fuel connections were allowed to operate for eight hours only from Monday to Friday. A flying squad of the Commission had visited and inspected the service centre run by AMPL at Okhla Industrial Estate, New Delhi to verify the compliance with the Directions and found that the service centre was allegedly operating without obtaining consent to operate from Delhi Pollution Control Committee in gross violation of the Directions. The Enforcement Task Force, based on the report of the flying squad, decided to order the closure of the service centre at Okhla until further orders and to take legal actions against AMPL. In view of the above, the Commission directed immediate closure of the industrial operations of AMPL at Okhla Industrial Estate, New Delhi and authorised the Member Secretary of the Commission to initiate prosecution under Section 14 of the Commission for Air Quality Management in National Capital Region and Adjoining Areas Act, 2021. The matter is currently pending.

**(2) Other material pending proceedings**

Except as mentioned below, as on the date of this Draft Red Herring Prospectus, there are no other pending proceedings initiated against AMPL, which have been considered material by our Company in accordance with the Materiality Policy.

- (1) Narendrakumar Somabhai Patel (“**Complainant**”) filed a complaint (“**Complaint**”) before the Consumer Forum Commission at Ahmedabad (“**State Commission**”) against AMPL and others. In relation to a vehicle which the Complainant had purchased from AMPL, the Complainant alleged that the vehicle failed to deploy the airbags during an accident involving the Complainant and alleged that there had been negligence, deficiency in service, manufacturing defects in several components of the vehicle and unfair trade practices on the part of AMPL. The Complainant has prayed for *inter alia* replacement of the vehicle and refund the amount of ₹ 0.28 million which was paid as service cost by the Complainant. Further, the Complainant has also sought

compensation aggregating to ₹ 10.00 million, for mental harassment and legal expenses. The matter is currently pending.

(2) **Claims related to direct and indirect taxes**

Except as mentioned below, there are no pending claims related to direct and indirect taxes against AMPL as on the date of this Draft Red Herring Prospectus:

(in ₹ million)

Nature of proceeding	Number of proceedings outstanding	Amount involved*
Direct tax	Nil	Nil
Indirect tax	5	101.86
Other tax <sup>^</sup>	1	11.02
<b>Total</b>	<b>6</b>	<b>112.88</b>

\* To the extent quantified.

<sup>^</sup>Includes municipal tax notice

V. **Landmark Automobiles Private Limited (“LAPL”)**

(i) **Criminal proceedings**

As on the date of this Draft Red Herring Prospectus, except as stated below, there are no outstanding criminal proceedings filed against LAPL.

An FIR has been filed by Govind Yadav (“**Complainant**”) before MIG Police Station, Indore against LAPL and its employees alleging criminal breach of trust and cheating in failing to provide the delivery of the vehicle duly purchased by the Complainant after paying the consideration amount in full. The matter is currently pending.

The Complainant also filed a complaint before the District Consumer Dispute Redressal Tribunal, Indore. For details, see “*Litigation involving our Subsidiaries- Outstanding litigation proceedings against our Subsidiaries – Landmark Automobiles Private Limited (“LAPL”) – Other material pending proceedings*” on page 321.

(ii) **Actions by statutory or regulatory authorities**

As on the date of this Draft Red Herring Prospectus, there are no pending actions initiated by any statutory or regulatory authority against LAPL.

(iii) **Other material pending proceedings**

As on the date of this Draft Red Herring Prospectus, except as disclosed below, there are no other pending proceedings initiated against LAPL, which have been considered material by our Company in accordance with the Materiality Policy.

- (1) Govind Yadav (“**Complainant**”) filed a complaint against LAPL before the District Consumer Dispute Redressal Tribunal, Indore alleging *inter alia* that LAPL had failed to provide the delivery of the vehicle purchased by the by the Complainant even after paying the consideration amount in full. Accordingly, the Complainant has claimed an amount of ₹ 3.13 million along with an interest of 12% for *inter alia* non-delivery of the vehicle, physical torture and economic loss. The matter is currently pending.

The Complainant also filed an FIR. For details, see “*Litigation involving our Subsidiaries- Outstanding litigation proceedings against our Subsidiaries - Landmark Automobiles Private Limited (“LAPL”) - Criminal Proceedings*” on page 321.

(2) **Claims related to direct and indirect taxes**

Except as mentioned below, there are no pending claims related to direct and indirect taxes against LAPL as on the date of this Draft Red Herring Prospectus:

(in ₹ million)

Nature of proceeding	Number of proceedings outstanding	Amount involved*
Direct tax	3	1.30
Indirect tax	4	46.66

Nature of proceeding	Number of proceedings outstanding	Amount involved*
Other tax <sup>^</sup>	1	10.43
<b>Total</b>	<b>8</b>	<b>58.39</b>

\* To the extent quantified.

<sup>^</sup>Includes municipal tax notice

## VI. Benchmark Motors Private Limited (“BMPL”)

### (i) Criminal proceedings

As on the date of this Draft Red Herring Prospectus, there are no outstanding criminal proceedings filed against BMPL.

### (ii) Actions by statutory or regulatory authorities

As on the date of this Draft Red Herring Prospectus, there are no pending actions initiated by any statutory or regulatory authority against BMPL.

### (iii) Other material pending proceedings

As on the date of this Draft Red Herring Prospectus, there are no other pending proceedings initiated against BMPL, which have been considered material by our Company in accordance with the Materiality Policy.

### (iv) Claims related to direct and indirect taxes

Except as mentioned below, there are no pending claims related to direct and indirect taxes against BMPL as on the date of this Draft Red Herring Prospectus:

(in ₹ million)

Nature of proceeding	Number of proceedings outstanding	Amount involved*
Direct tax	Nil	Nil
Indirect tax	1	5.19
<b>Total</b>	<b>1</b>	<b>5.19</b>

\* To the extent quantified.

## VII. Watermark Cars Private Limited (“WCPL”)

### (i) Criminal proceedings

As on the date of this Draft Red Herring Prospectus, there are no outstanding criminal proceedings filed against WCPL.

### (ii) Actions by statutory or regulatory authorities

As on the date of this Draft Red Herring Prospectus, there are no pending actions initiated by any statutory or regulatory authority against WCPL.

### (iii) Other material pending proceedings

As on the date of this Draft Red Herring Prospectus, there are no other pending proceedings initiated against WCPL, which have been considered material by our Company in accordance with the Materiality Policy.

### (iv) Claims related to direct and indirect taxes

Except as mentioned below, there are no pending claims related to direct and indirect taxes against WCPL as on the date of this Draft Red Herring Prospectus:

(in ₹ million)

Nature of proceeding	Number of proceedings outstanding	Amount involved*
Direct tax	Nil	Nil
Indirect tax	1	0.97
<b>Total</b>	<b>1</b>	<b>0.97</b>

*\* To the extent quantified.*

**b. Outstanding litigation proceedings initiated by our Subsidiaries**

**I. Landmark Cars (East) Private Limited (“LCEPL”)**

**(i) Criminal proceedings**

*As on the date of this Draft Red Herring Prospectus, there are no outstanding criminal proceedings initiated by LCEPL.*

**(ii) Other material pending proceedings**

*As on the date of this Draft Red Herring Prospectus, there are no material pending proceedings filed by LCEPL, which have been considered material by our Company in accordance with the Materiality Policy.*

**II. Landmark Commercial Vehicles Private Limited (“LCVPL”)**

**(i) Criminal proceedings**

*As on the date of this Draft Red Herring Prospectus, there are no outstanding criminal proceedings initiated by LCVPL.*

**(ii) Other material pending proceedings**

*As on the date of this Draft Red Herring Prospectus, there are no material pending proceedings filed by LCVPL, which have been considered material by our Company in accordance with the Materiality Policy.*

**III. Landmark Lifestyle Cars Private Limited (“LLCPL”)**

**(i) Criminal proceedings**

*Except as stated below, as on the date of this Draft Red Herring Prospectus, there are no outstanding criminal proceedings initiated by LLCPL.*

- (1) Surendra Kumar Agarwal, on behalf of LLCPL (“**Complainant**”) filed a first information report (“**FIR**”) with the Worli Police Station, Mumbai, against Amit Mishra, an employee of LLCPL (“**Accused**”). The Complainant alleged that during a statutory audit conducted, it was found that in the course of the Accused’s employment with LLCPL, he was *inter alia* involved in irregularity, fraud, conspiracy, breach of trust, financial scam, tempering of documents and emails and had embezzled the money of LLCPL amounting to ₹ 9.74 million. Further, the Accused transferred the embezzled money from LLCPL’s account to third party accounts for his personal benefits. The matter is currently pending.

**(ii) Other material pending proceedings**

*As on the date of this Draft Red Herring Prospectus, there are no other pending proceedings filed by LLCPL, which have been considered material by our Company in accordance with the Materiality Policy.*

**IV. Automark Motors Private Limited (“AMPL”)**

**(i) Criminal proceedings**

*Except as stated below, as on the date of this Draft Red Herring Prospectus, there are no outstanding criminal proceedings initiated by AMPL.*

- (a) As of the date of this Draft Red Herring Prospectus, there is one case filed by AMPL under the Negotiable Instruments Act, 1881 in relation to the dishonour of cheques. The amount involved in this matter is of ₹ 0.35 million. This matter is currently pending.
- (b) AMPL, through its representative Lalan Yadav (“**Complainant**”) filed a complaint before the Police Station, Badarpur, New Delhi alleging several malpractices by one Shashi Kanta Parida (“**Accused**”) with an intent to

cheat and fraud. The Accused was employed in AMPL as an accounts manager and left the services on his own accord. The Complainant alleged that, the Accused is found to have absconded with critical customer data and money. This matter is currently pending.

**(ii) Other material pending proceedings**

*As on the date of this Draft Red Herring Prospectus, there are no other pending proceedings pending filed by AMPL, which have been considered material by our Company in accordance with the Materiality Policy.*

**V. Landmark Automobiles Private Limited (“LAPL”)**

**(i) Criminal proceedings**

*As on the date of this Draft Red Herring Prospectus, there are no outstanding criminal proceedings initiated by LAPL.*

**(ii) Other material pending proceedings**

*As on the date of this Draft Red Herring Prospectus, there are no other pending proceedings filed by LAPL, which have been considered material by our Company in accordance with the Materiality Policy.*

**VI. Benchmark Motors Private Limited (“BMPL”)**

**(i) Criminal proceedings**

*As on the date of this Draft Red Herring Prospectus, there are no outstanding criminal proceedings initiated by BMPL.*

**(ii) Other material pending proceedings**

*As on the date of this Draft Red Herring Prospectus, there are no other pending proceedings pending filed by BMPL, which have been considered material by our Company in accordance with the Materiality Policy*

**VII. Watermark Cars Private Limited (“WCPL”)**

**(i) Criminal proceedings**

*As on the date of this Draft Red Herring Prospectus, there are no outstanding criminal proceedings initiated by WCPL.*

**(ii) Other material pending proceedings**

*As on the date of this Draft Red Herring Prospectus, there are no other pending proceedings filed by WCPL, which have been considered material by our Company in accordance with the Materiality Policy.*

**LITIGATION INVOLVING OUR DIRECTORS**

**(a) Outstanding litigation proceedings against Directors**

**(i) Criminal proceedings against our Directors**

Except as disclosed above under “-Outstanding litigation proceedings against our Company – Criminal Proceedings” on page 313, there are no pending criminal proceedings against any of our Directors as on date of this Draft Red Herring Prospectus.

**(ii) Actions by statutory or regulatory authorities**

As on the date of this Draft Red Herring Prospectus there are no actions by regulatory or statutory authorities initiated against our Directors.

**(iii) Other material pending proceedings**

Except as disclosed above under “- *Outstanding litigation proceedings against our Company – Other material pending proceedings*” on page 314, “- *Outstanding litigation proceedings against our Subsidiaries – Landmark Cars (East) Private Limited (“LCEPL”) - Other material pending proceedings*” on page 317, “- *Outstanding litigation proceedings against our Subsidiaries – Landmark Lifestyle Cars Private Limited (“LLCPL”) - Other material pending proceedings*” on page 319, there are no other pending proceedings pending against our Directors, which have been considered material by our Company in accordance with the Materiality Policy as on date of this Draft Red Herring Prospectus.

**(iv) *Claims related to direct and indirect taxes***

There are no pending claims related to direct and indirect taxes against our Directors as on the date of this Draft Red Herring Prospectus.

**(b) *Outstanding litigation proceedings by our Directors***

**(i) *Criminal proceedings***

As on the date of this Draft Red Herring Prospectus there are no outstanding criminal proceedings initiated by our Directors.

**(ii) *Other material pending proceedings***

As on the date of this Draft Red Herring Prospectus, there are no other pending proceedings pending against our Directors, which have been considered material by our Company in accordance with the Materiality Policy.

**LITIGATION INVOLVING OUR PROMOTER**

**(a) *Outstanding litigation proceedings against our Promoter***

**(i) *Criminal proceedings***

Except as disclosed above under “*Litigation involving our Directors - Outstanding litigation proceedings against our Directors – Criminal proceedings against our Directors*” on page 324, there are no pending criminal proceedings against our Promoter as on date of this Draft Red Herring Prospectus.

**(ii) *Actions by statutory or regulatory authorities***

As on the date of this Draft Red Herring Prospectus there are no actions by regulatory or statutory authorities initiated against our Promoter.

**(iii) *Other material pending proceedings***

Except as disclosed above under “*Litigation involving our Directors - Outstanding litigation proceedings against our Directors – Other material pending proceedings*” on page 325, there are no pending criminal proceedings against our Promoter as on date of this Draft Red Herring Prospectus.

**(iv) *Claims related to direct and indirect taxes***

There are no pending claims related to direct and indirect taxes against our Promoter as on the date of this Draft Red Herring Prospectus.

**(v) *Disciplinary action taken against our Promoter in the five Fiscals preceding the date of this Draft Red Herring Prospectus by SEBI or any stock exchange.***

*There are no disciplinary action taken against our Promoter in the five Fiscals preceding the date of this Draft Red Herring Prospectus by SEBI or any stock exchange.*

**OUTSTANDING DUES TO CREDITORS**

Further, in accordance with the Materiality Policy, our Company has considered such creditors material to whom the amount due is equal to or in excess of 5% of the consolidated trade payables of our Company as of the end of the most



recent period covered in the Restated Consolidated Financial Information, i.e. ₹52.89 million, as of September 30, 2021 (“**Material Creditors**”).

The details of the total outstanding overdues (trade payables) owed to micro, small and medium enterprises (as defined under Section 2 of the Micro, Small and Medium Enterprises Development Act, 2006), Material Creditors and other creditors as on September 30, 2021 is as set forth below:

<b>Particulars</b>	<b>Number of creditors*</b>	<b>Amount involved (in ₹ million)</b>
Dues to micro enterprises and small enterprises	143	19.41
Dues to Material Creditor(s) (as defined above)	3	541.61
Dues to other creditors	2,676	496.76
<b>Total</b>	<b>2,822</b>	<b>1,057.78</b>

\* In the count of number of creditors 2,822, numbers in respect of expenses payables including salary payables and provision for expenses have not been included therein, however, amount of the same have been included in total amount of ₹1,057.78 million owed to creditors as of September 30, 2021.

The details pertaining to outstanding dues to Material Creditors, along with the name and amount involved for each such Material Creditor, are available on the website of our Company at <https://www.grouplandmark.in/corporate-document/>.

It is clarified that information provided on the website of our Company is not a part of this Draft Red Herring Prospectus and should not be deemed to be incorporated by reference. Anyone placing reliance on any other source of information, including our Company’s website, [www.grouplandmark.in](http://www.grouplandmark.in) would be doing so at their own risk.

#### **Material Developments**

Except as disclosed in “*Management’s Discussion and Analysis of Financial Position and Results of Operations – Significant Developments after September 30, 2021 that may affect our future results of operations*” on page 309, no circumstances have arisen since September 30, 2021, which may materially and adversely affect, or are likely to affect our profitability, our operations, the value of our consolidated assets or our ability to pay our material liabilities within the next 12 months.

## GOVERNMENT AND OTHER APPROVALS

Our Company and our Material Subsidiaries consider certain approvals, consents, registrations and licenses from various governmental and regulatory authorities as material for the purpose of undertaking our business activities and operations (“**Material Approvals**”). Except as disclosed herein and in “Risk Factors” beginning on page 28, our Company and the Material Subsidiaries have obtained all the Material Approvals. In the event any of the Material Approvals expire in the ordinary course, we make applications for their renewal from time to time. Unless otherwise stated, these approvals are valid as on the date of this Draft Red Herring Prospectus. For details in connection with the regulatory and legal framework within which we operate, see “Key Regulations and Policies in India” on page 161.

For Offer related approvals, see “Other Regulatory and Statutory Disclosures” on page 331, for incorporation details of our Company, see “History and Certain Corporate Matters” on page 166 and for incorporation details of our Material Subsidiaries, see “Our Subsidiaries” on page 173.

### A. Key approvals in relation to our Company and Material Subsidiaries

#### *Tax Related Approvals*

We are required to obtain registrations under various national tax laws and state specific tax laws such as the Income Tax Act, 1961, Central Goods and Services Tax Act, 2017 and any other tax legislation as applicable, state wise. We have obtained the Material Approvals from the appropriate regulatory and governing authorities in relation to such tax laws.

### B. Key approvals in relation to the business operations of our Company and Material Subsidiaries

#### (i) Approvals in relation to our sales operations:

In respect of the corporate offices, sales outlets and workshops of our Company and Material Subsidiaries, we are required to obtain and maintain certain registrations and licenses such as certificates of registration for shops and establishments, under the shops and establishments legislations applicable in the states in which establishments are set up. We have obtained all Material Approvals in relation to our sales operations. Certain registrations, and licenses, may have lapsed in their normal course and we have either made applications to the appropriate authorities for renewal of such registrations, and/or licenses or we are in the process of making such applications.

#### (ii) Approvals in relation to our service centre operations:

In respect of the service centres of our Company and Material Subsidiaries, we are required to obtain and maintain certain permits, registrations, approvals and licenses under the provisions of relevant legislations, including, *inter alia*, factory licenses, pollution consents and panchayat/ municipal/ corporation licenses. Further, a few of our service centres are required to obtain relevant consents from the pollution control boards of the respective states, as well as fire no-objection certificates from the relevant fire services departments. We have obtained all Material Approvals in relation to our service centres. Certain Material Approvals may have lapsed in their normal course and we have either made applications to the appropriate authorities for renewal of such permits, registrations, approvals and/or licenses or are in the process of making such applications.

(a) *The Material Approvals and renewals applied for but not received.*

Application applied for	Authority	Date of application
<b>Company</b>		
No objection certificate for fire equipment for premises situated at Ambali-Bopal, Ahmedabad	Chief Fire Officer, Ahmedabad Municipal Corporation	November 11, 2021
No objection certificate for fire equipment for premises situated at Sola, Ahmedabad	Chief Fire Officer, Ahmedabad Municipal Corporation	November 11, 2021
No objection certificate for fire equipment for premises situated at Piplod, Surat	Chief Fire Officer, Fire and Emergency Services, Muglisara, Surat	December 31, 2021
No objection certificate for fire equipment for premises situated at Atladra, Vadodara	Chief Fire Officer, Vadodara Mahanagar Palika	December 17, 2020

Application applied for	Authority	Date of application
<b>LAPL</b>		
No objection certificate for fire equipment for premises situated at Ishanpur, Ahmedabad	Chief Fire Officer, Ahmedabad Municipal Corporation	November 11, 2021
Factory License for premises situated at Jamnagar Rajkot Highway, Happa, Jamnagar	Labour and Employment Department	December 28, 2021
No objection certificate for fire equipment for premises situated at Thaltej, Ahmedabad	Chief Fire Officer, Ahmedabad Municipal Corporation-Fire & Emergency Services Department	November 11, 2021
No objection certificate for fire equipment for premises situated at Thaltej, Ahmedabad	Chief Fire Officer, Ahmedabad Municipal Corporation-Fire & Emergency Services Department	November 11, 2021
Factory License for premises situated at Vesu, Chorasi, Surat	Labour and Employment Department	December 28, 2021
No objection certificate for fire equipment for premises situated at Vesu, Surat	Chief Fire Officer, Fire and Emergency Services, Muglisara, Surat	December 31, 2021
No objection certificate for fire equipment for premises situated at Piplod, Surat	Chief Fire Officer, Fire and Emergency Services, Muglisara, Surat	December 31, 2021
<b>AMPL</b>		
No objection certificate for fire equipment for premises situated at Narol, Ahmedabad	Chief Fire Officer, Ahmedabad Municipal Corporation-Fire & Emergency Services Department	November 11, 2021
Factory license for premises situated at Gondal, Rajkot	Labour and Employment Department	December 28, 2021
Trade license for the premises at Faridabad, Haryana	Joint Commissioner, Municipal Corporation, Faridabad	September 22, 2021
No objection certificate for fire equipment installed at premises situated at Ashram Road-Ahmedabad	Chief Fire Officer, Ahmedabad Municipal Corporation-Fire & Emergency Services Department	November 11, 2021
<b>LLCPL</b>		
No objection certificate from the pollution control board for the premises situated at Andheri, Mumbai	Maharashtra Pollution Control Board	July 21, 2021
No objection certificate for fire equipment installed at premises situated at Thane, Maharashtra	The Fire Officer, Mira-Bhayandar Municipal Corporation, Bhayandar	July 1, 2021

(b) *The Material Approvals which have expired and are yet to be applied for.*

Applications yet to be applied for	Authority
<b>Company</b>	
No objection certificate for fire equipment for premises situated at Govindpura, Bhopal	Fire Authority Officer, Nagar Palika, Bhopal
No objection certificate for fire equipment for premises situated at Gondal Road, Rajkot	Chief Fire Officer, Rajkot Municipal Corporation
<b>LAPL</b>	
No objection certificate for fire equipment for premises situated at Jamnagar- Ahmedabad	Chief Fire Officer, Ahmedabad Municipal Corporation
No objection certificate for fire equipment for premises situated at Rajkot	Chief Fire Officer, Rajkot Municipal Corporation
Factory License for premises situated at Vapi, Gujarat	Directorate Industrial Safety and Health
No objection certificate for fire equipment for premises situated at Vapi, Gujarat	Chief Fire Officer, Vapi Municipal Corporation
<b>AMPL</b>	
No objection certificate for fire equipment installed at premises situated at Rajkot-Ahmedabad	Chief Fire Officer, Ahmedabad Municipal Corporation-Fire & Emergency Services Department

<b>Applications yet to be applied for</b>	<b>Authority</b>
<b>BMPL</b>	
No objection certificate for fire equipment installed at premises situated at Jalandhar, Punjab	Fire Station Officer, Punjab Fire Services
No objection certificate for fire equipment installed at premises situated at Ambala, Haryana	Fire Station Officer, Haryana Fire Services
No objection certificate for fire equipment installed at premises situated at Panchkula, Haryana	Fire Station Officer, Haryana Fire Services
<b>LLCPL</b>	
No objection certificate for fire equipment installed at premises situated at Thane, Maharashtra	Municipal Corporation of Greater Mumbai
License to affix glow signs on the premises situated at Andheri, Mumbai.	Municipal Corporation of Greater Mumbai
License to affix glow signs on the premises situated at Worli, Mumbai	Municipal Corporation of Greater Mumbai

### **C. Intellectual Property**

For information in relation to the trademarks licensed by our Company, please see “*Our Business – Intellectual Property*” on page 159.

## OTHER REGULATORY AND STATUTORY DISCLOSURES

### Authority for the Offer

The Offer has been authorised by our Board pursuant to a resolution dated January 11, 2022 and the Fresh Issue has been authorised by the Shareholders pursuant to a special resolution dated January 11, 2022 under Section 62(1)(c) of the Companies Act 2013. Further, our IPO committee has taken on record the respective approvals for the Offer for Sale by the Selling Shareholders in its meeting held on January 11, 2022.

Our Board has approved this Draft Red Herring Prospectus pursuant to their resolution dated January 17, 2022.

The IPO Committee has approved this Draft Red Herring Prospectus pursuant to their resolution dated January 18, 2022.

The Offer for Sale has been authorised by the Selling Shareholders as follows:

Selling Shareholder	Offered Shares in	Date of authorization letter/ board resolution	Date of consent letter
TPG Growth	Up to ₹ 4,000.00 million	December 15, 2021	January 18, 2022
Sanjay Karsandas Thakker HUF	Up to ₹ 620.00 million	-	January 11, 2022
Aastha Limited	Up to ₹ 1,200.00 million	January 11, 2022	January 11, 2022
Garima Misra	Up to ₹ 300.00 million	-	January 11, 2022

Our Company received in-principle approvals from BSE and NSE for the listing of the Equity Shares pursuant to letters dated [●] and [●], respectively.

### Prohibition by SEBI or other Governmental Authorities

Our Company, our Subsidiaries, our Promoter, our Directors, the members of the Promoter Group and the Selling Shareholders, are not prohibited from accessing the capital markets or debarred from buying, selling or dealing in securities under any order or direction passed by SEBI or any securities market regulator in any jurisdiction or any other authority/court.

### Compliance with the Companies (Significant Beneficial Ownership) Rules, 2018

Our Company, the Selling Shareholders, our Promoter and the members of the Promoter Group are in compliance with the Companies (Significant Beneficial Ownership) Rules, 2018, to the extent applicable.

### Directors associated with the Securities Market

Other than Manish Balkishan Chokhani, who is a director and shareholder of Quadrillion Capital Private Limited (registered as a stock broker with SEBI) and Sucheta Nilesh Shah, who is a whole-time director of Atlas Integrated Finance Limited (registered as a stock broker and portfolio manager with SEBI and registered with CDSL), none of the Directors are, in any manner, associated with the securities market. Further, there are no outstanding action(s) initiated by SEBI against the Directors of our Company in the five years preceding the date of this Draft Red Herring Prospectus.

### Eligibility for the Offer

Our Company is eligible for the Offer in accordance with Regulation 6(1) of the SEBI ICDR Regulations, and is in compliance with the conditions specified therein in the following manner:

- Our Company has had net tangible assets of at least ₹30 million, calculated on a restated and consolidated basis, in each of the preceding three full years (of 12 months each);
- Our Company has an average operating profit of at least ₹150 million, calculated on a restated and consolidated basis, during the preceding three years (of 12 months each), with operating profit in each of these preceding three years;
- Our Company has a net worth of at least ₹10 million in each of the preceding three full years (of 12 months each), calculated on a restated and consolidated basis; and

- Our Company has not changed its name in the last one year, other than the deletion of the word “Private” from the name of our Company pursuant to conversion to a public limited company. The Company has not undertaken any new activity pursuant to such change in name.
- Our Company’s net tangible assets, operating profits, net worth, monetary assets and monetary assets as a percentage of our net tangible assets, as derived from the Restated Consolidated Financial Information included in this Draft Red Herring Prospectus as at, and for the last three Fiscals are set forth below:

(in ₹ million, unless otherwise stated)

Particulars	As at and for the Fiscal ended March 31,		
	2021	2020	2019
Restated net tangible assets <sup>1</sup>	1,767.49	1,541.89	1,761.51
Restated pre-tax operating profit <sup>2</sup>	473.47	99.24	271.13
Restated consolidated net worth <sup>3</sup>	1,817.75	1,691.25	1,879.64
Restated consolidated monetary assets <sup>4</sup>	227.20	333.27	365.68
Monetary assets as restated as a percentage of the net tangible assets <sup>5</sup>	12.85%	21.61%	20.76%

**Notes:**

- <sup>1)</sup> “Net tangible assets” means the sum of all net assets of the Company and its Subsidiaries (together, the “Group”) excluding intangible assets, goodwill, deferred tax assets, right of use assets and intangible assets under development, lease liabilities and deferred tax liabilities of the Group.”
- <sup>2)</sup> “Restated pre-tax operating profit” means restated profit before tax excluding other income and finance costs.”
- <sup>3)</sup> “Net worth” means the aggregate value of the paid-up share capital and other equity.”
- <sup>4)</sup> “Monetary Assets” means the aggregate of Cash and Cash Equivalents and Other balances with banks.”
- <sup>5)</sup> “Monetary assets as restated as a percentage of the net tangible assets” means monetary assets as restated divided by net tangible assets, as restated, expressed as a percentage.”

Our average operating profit for Fiscals 2021, 2020 and 2019, is ₹ 281.28 million.

Our Company confirms that it is in compliance with the conditions specified in Regulation 7(1) of the SEBI ICDR Regulations, to the extent applicable.

Further, our Company confirms that it is not ineligible to make the Offer in terms of Regulation 5 of the SEBI ICDR Regulations, to the extent applicable.

The details of our compliance with Regulation 5 and Regulation 7(1) of the SEBI ICDR Regulations are as follows:

- (a) None of our Company, our Promoter, members of our Promoter Group, our Directors or the Selling Shareholders are debarred from accessing the capital markets by SEBI.
- (b) None of our Promoter or Directors are promoters or directors of companies which are debarred from accessing the capital markets by SEBI.
- (c) None of our Company, our Promoter or Directors is a Wilful Defaulter.
- (d) None of our Company, our Promoter or Directors is a Fraudulent Borrower.
- (e) None of our Promoter or Directors has been declared a Fugitive Economic Offender.
- (f) Other than options outstanding in terms of the ESOP Scheme, there are no outstanding convertible securities of our Company or any other right which would entitle any person with any option to receive Equity Shares of our Company as on the date of filing of this Draft Red Herring Prospectus;
- (g) Our Company along with Registrar to the Offer has entered into tripartite agreements dated December 31, 2021, and December 16, 2021 with NSDL and CDSL, respectively, for dematerialization of the Equity Shares;
- (h) The Equity Shares of our Company held by the Promoter are in the dematerialised form; and
- (i) All the Equity Shares are fully paid-up and there are no partly paid-up Equity Shares as on the date of filing of this Draft Red Herring Prospectus.

Each of the Selling Shareholders has severally and not jointly confirmed compliance with Regulation 8 of the SEBI ICDR Regulations and approved its participation in the Offer for Sale in relation to its portion of the Offered Shares.

## **DISCLAIMER CLAUSE OF SEBI**

**IT IS TO BE DISTINCTLY UNDERSTOOD THAT SUBMISSION OF THIS DRAFT RED HERRING PROSPECTUS TO SEBI SHOULD NOT, IN ANY WAY, BE DEEMED OR CONSTRUED THAT THE SAME HAS BEEN CLEARED OR APPROVED BY SEBI. SEBI DOES NOT TAKE ANY RESPONSIBILITY EITHER FOR THE FINANCIAL SOUNDNESS OF ANY SCHEME OR THE PROJECT FOR WHICH THE OFFER IS PROPOSED TO BE MADE OR FOR THE CORRECTNESS OF THE STATEMENTS MADE OR OPINIONS EXPRESSED IN THIS DRAFT RED HERRING PROSPECTUS. THE BRLMs, BEING AXIS CAPITAL LIMITED AND ICICI SECURITIES LIMITED HAVE CERTIFIED THAT THE DISCLOSURES MADE IN THIS DRAFT RED HERRING PROSPECTUS ARE GENERALLY ADEQUATE AND ARE IN CONFORMITY WITH THE SECURITIES AND EXCHANGE BOARD OF INDIA (ISSUE OF CAPITAL AND DISCLOSURE REQUIREMENTS) REGULATIONS, 2018, AS AMENDED. THIS REQUIREMENT IS TO FACILITATE INVESTORS TO TAKE AN INFORMED DECISION FOR MAKING AN INVESTMENT IN THE PROPOSED OFFER.**

**IT SHOULD ALSO BE CLEARLY UNDERSTOOD THAT WHILE THE COMPANY IS PRIMARILY RESPONSIBLE FOR THE CORRECTNESS, ADEQUACY AND DISCLOSURE OF ALL RELEVANT INFORMATION IN THIS DRAFT RED HERRING PROSPECTUS, THE BRLMs ARE EXPECTED TO EXERCISE DUE DILIGENCE TO ENSURE THAT THE COMPANY DISCHARGES ITS RESPONSIBILITY ADEQUATELY IN THIS BEHALF AND TOWARDS THIS PURPOSE, THE BRLMs HAVE FURNISHED TO SEBI, A DUE DILIGENCE CERTIFICATE DATED JANUARY 18, 2022, IN THE FORMAT PRESCRIBED UNDER SCHEDULE V (FORM A) OF THE SECURITIES AND EXCHANGE BOARD OF INDIA (ISSUE OF CAPITAL AND DISCLOSURE REQUIREMENTS) REGULATIONS, 2018, AS AMENDED.**

**THE FILING OF THIS DRAFT RED HERRING PROSPECTUS DOES NOT, HOWEVER, ABSOLVE THE COMPANY FROM ANY LIABILITIES UNDER THE COMPANIES ACT, 2013 OR FROM THE REQUIREMENT OF OBTAINING SUCH STATUTORY OR OTHER CLEARANCES AS MAY BE REQUIRED FOR THE PURPOSE OF THE OFFER. SEBI FURTHER RESERVES THE RIGHT TO TAKE UP, AT ANY POINT OF TIME, WITH THE BRLMs, ANY IRREGULARITIES OR LAPSES IN THIS DRAFT RED HERRING PROSPECTUS.**

### **Disclaimer from our Company, our Directors, the Selling Shareholders and the BRLMs**

Our Company, the Directors and the BRLMs accept no responsibility for statements made otherwise than in this Draft Red Herring Prospectus or in the advertisements or any other material issued by or at our Company's instance and anyone placing reliance on any other source of information, including our Company's website [www.grouplandmark.in](http://www.grouplandmark.in) would be doing so at his or her own risk. Each Selling Shareholders, and their respective directors, affiliates, associates and officers accept or undertake no responsibility for any statements other than those specifically undertaken or confirmed by the Selling Shareholder in relation to itself and its Offered Shares and in this Draft Red Herring Prospectus or in the advertisements or any other material issued in connection with the Offer.

The BRLMs accept no responsibility, save to the limited extent as provided in the Offer Agreement and as will be provided for in the Underwriting Agreement.

All information, to the extent required in relation to the Offer, shall be made available by our Company and the BRLMs to the public and investors at large and no selective or additional information would be available for a section of the investors in any manner whatsoever, including at road show presentations, in research or sales reports, at Bidding centres or elsewhere.

Bidders will be required to confirm and will be deemed to have represented to our Company, the Selling Shareholders, Underwriters and their respective directors, partners, designated partners, officers, agents, affiliates, and representatives that they are eligible under all applicable laws, rules, regulations, guidelines and approvals to acquire the Equity Shares and will not issue, sell, pledge, or transfer the Equity Shares to any person who is not eligible under any applicable laws, rules, regulations, guidelines and approvals to acquire the Equity Shares. Our Company, the Selling Shareholders, Underwriters and their respective directors, partners, designated partners, officers, agents, affiliates, employees and representatives accept no responsibility or liability for advising any investor on whether such investor is eligible to acquire the Equity Shares.

The BRLMs and their respective associates and affiliates in their capacity as principals or agents may engage in

transactions with, and perform services for, our Company, the Selling Shareholders and their respective group companies, directors and officers, affiliates, associates or third parties in the ordinary course of business and have engaged, or may in the future engage, in commercial banking and investment banking transactions with our Company, the Selling Shareholders and their respective group companies, directors and officers, affiliates, associates or third parties, for which they have received, and may in the future receive, compensation.

### **Disclaimer in respect of Jurisdiction**

Any dispute arising out of the Offer will be subject to the jurisdiction of appropriate court(s)/authorities in Mumbai only.

The Offer is being made in India to persons resident in India (including Indian nationals resident in India who are competent to contract under the Indian Contract Act, 1872, HUFs, companies, corporate bodies and societies registered under the applicable laws in India and authorised to invest in shares, Indian Mutual Funds registered with SEBI, Indian financial institutions, commercial banks, regional rural banks, co-operative banks (subject to RBI permission), or trusts under applicable trust law and who are authorised under their constitution to hold and invest in shares, multilateral and bilateral development financial institutions, state industrial development corporations, insurance companies registered with IRDAI, provident funds (subject to applicable law) and pension funds, National Investment Fund, insurance funds set up and managed by the army and navy and insurance funds set up and managed by the Department of Posts, India) and permitted Non-Residents including FPIs and Eligible NRIs, AIFs, FVCIs (under Schedule I of the FEMA NDI Rules) and other eligible foreign investors, if any, provided that they are eligible under all applicable laws and regulations to purchase the Equity Shares.

This Draft Red Herring Prospectus does not constitute an invitation to subscribe to or purchase the Equity Shares in the Offer in any jurisdiction, including India. Invitations to subscribe to or purchase the Equity Shares in the Offer will be made only pursuant to the Red Herring Prospectus if the recipient is in India or the preliminary offering memorandum for the Offer, which comprises the Red Herring Prospectus and the preliminary international wrap for the Offer, if the recipient is outside India. No person outside India is eligible to Bid for Equity Shares in the Offer unless that person has received the preliminary offering memorandum for the Offer, which contains the selling restrictions for the Offer outside India.

Bidders are advised to ensure that any Bid from them does not exceed investment limits or the maximum number of Equity Shares that can be held by them under applicable law.

### **Eligibility and Transfer Restrictions**

**The Equity Shares offered in the Offer have not been and will not be registered under the U.S. Securities Act or any state securities laws of the United States and, unless so registered, may not be offered or sold within the United States, except pursuant to an exemption from, or in a transaction not subject to, the registration requirements of the U.S. Securities Act and applicable state securities laws of the United States. Accordingly, the Equity Shares are being offered and sold only outside the United States in offshore transactions in compliance with Regulation S under the U.S. Securities Act and the applicable laws of the jurisdictions where those offers and sales are made.**

**The Equity Shares have not been and will not be registered, listed or otherwise qualified in any other jurisdiction outside India and may not be offered or sold, and Bids may not be made by persons in any such jurisdiction, except in compliance with the applicable laws of such jurisdiction.**

### ***Equity Shares Offered and Sold in this Offer***

Each purchaser that is acquiring the Equity Shares offered pursuant to this Offer outside the United States, by its acceptance of this Draft Red Herring Prospectus and of the Equity Shares offered pursuant to this Offer, will be deemed to have acknowledged, represented to and agreed with our Company and the BRLMs that it has received a copy of this Draft Red Herring Prospectus and such other information as it deems necessary to make an informed investment decision and that:

1. the purchaser is authorized to consummate the purchase of the Equity Shares offered pursuant to this Offer in compliance with all applicable laws and regulations and will comply with all laws, regulations and restrictions which may be applicable in its jurisdiction and it has obtained or will obtain any consent, approval or authorization required for it to purchase and accept delivery of Equity Shares, and it acknowledges and agrees that none of the Company or the BRLMs and their respective affiliates shall have any responsibility in this regard;
2. the purchaser acknowledges that the Equity Shares offered pursuant to this Offer have not been and will not be



registered under the U.S. Securities Act or the securities laws of any state of the United States and accordingly may not be offered or sold within the United States, except pursuant to an exemption from, or in a transaction not subject to, the registration requirements of the U.S. Securities Act and applicable state securities laws;

3. the purchaser is purchasing the Equity Shares offered pursuant to this Offer in an offshore transaction meeting the requirements of Rule 903 of Regulation S under the U.S. Securities Act;
4. the purchaser is not purchasing the Equity Shares as a result of any "directed selling efforts" (as such term is defined in Rule 902 of Regulation S under the U.S. Securities Act);
5. the purchaser certifies that either (A) it is, or at the time the Equity Shares are purchased will be, the beneficial owner of the Equity Shares and is located outside the United States (within the meaning of Regulation S), and it has not purchased the Equity Shares for the account or benefit of any person in the United States or entered into any arrangement for the transfer of the Equity Shares or an economic interest therein to any person in the United States, or (B) it is a broker-dealer acting on behalf of its customer and its customer has confirmed to it that (i) such customer is, or at the time the Equity Shares are purchased will be, the beneficial owner of the Equity Shares, (ii) such customer is not located outside the United States (within the meaning of Regulation S), and (iii) such customer has not purchased the Equity Shares for the account or benefit of any person in the United States or entered into any arrangement for the transfer of the Equity Shares or an economic interest therein to any person in the United States;
6. the purchaser is not an affiliate of our Company or a person acting on behalf of an affiliate of our Company;
7. the purchaser understands and agrees (or if it is a broker-dealer acting on behalf of a customer, its customer has confirmed to it that such customer understands and agrees) that the Equity Shares are being offered in a transaction not involving any public offering in the United States within the meaning of the U.S. Securities Act, that the Equity Shares have not been and will not be registered under the U.S. Securities Act or any state securities laws in the United States and that if, in the future, the purchaser decides to offer, resell, pledge or otherwise transfer such Equity Shares, or any economic interest therein, such Equity Shares or any economic interest therein may be offered, resold, pledged or otherwise transferred only (A) pursuant to an exemption from or in a transaction not subject to, the registration requirements of the U.S. Securities Act and (B) in accordance with all applicable laws, including the securities laws of the States of the United States;
8. the purchaser agrees that neither the purchaser, nor any of its affiliates, nor any person acting on behalf of the purchaser or any of its affiliates, will make any "directed selling efforts" as defined in Regulation S under the U.S. Securities Act in the United States with respect to the Equity Shares;
9. if such purchaser is a dealer (as such term is defined under the U.S. Securities Act), it may not resell the Equity Shares in the United States prior to 40 days from the commencement of the offering of the Equity Shares; and
10. the purchaser acknowledges that our Company, the BRLMs, their respective affiliates and others will rely upon the truth and accuracy of the foregoing acknowledgements, representations and agreements and agrees that, if any of such acknowledgements, representations and agreements deemed to have been made by virtue of its purchase of such Equity Shares are no longer accurate, it will promptly notify our Company, and if it is acquiring any of such Equity Shares as a fiduciary or agent for one or more accounts, it represents that it has sole investment discretion with respect to each such account and that it has full power to make the foregoing acknowledgements, representations and agreements on behalf of such account.

#### **Disclaimer Clause of BSE**

As required, a copy of this Draft Red Herring Prospectus has been submitted to BSE. The disclaimer clause as intimated by BSE to our Company, post scrutiny of this Draft Red Herring Prospectus, shall be included in the Red Herring Prospectus and the Prospectus prior to the RoC filing.

#### **Disclaimer Clause of NSE**

As required, a copy of this Draft Red Herring Prospectus has been submitted to NSE. The disclaimer clause as intimated by NSE to our Company, post scrutiny of this Draft Red Herring Prospectus, shall be included in the Red Herring Prospectus and the Prospectus prior to the RoC filing.

#### **Listing**

The Equity Shares issued through the Red Herring Prospectus and the Prospectus are proposed to be listed on BSE and NSE. Applications will be made to the Stock Exchanges for obtaining permission for listing and trading of the Equity Shares. [●] will be the Designated Stock Exchange with which the Basis of Allotment will be finalised.

## **Consents**

Consents in writing of each of the Selling Shareholders, our Directors, our Company Secretary and Compliance Officer, the legal counsel to the Company as to Indian law, Individual Selling Shareholder and Other Selling Shareholders, legal counsel to the BRLMs as to Indian law, International Legal Counsel to the Book Running Lead Managers, legal counsel to the Investor Selling Shareholder as to Indian law, Advisor to the Company (for fund-raising including the Offer), the Registrar to the Offer, bankers/lenders to our Company (wherever applicable), independent chartered accountant and industry report provider have been obtained; and consents in writing of the Syndicate Members, Sponsor Bank(s), Escrow Collection Bank(s) and Refund Bank(s) to act in their respective capacities, will be obtained and filed along with a copy of the Red Herring Prospectus with the RoC as required under the Companies Act and such consents shall not be withdrawn up to the time of delivery of the Red Herring Prospectus for filing with the RoC.

## **Experts**

Except as stated below, our Company has not obtained any expert opinions:

Our Company has received written consent dated January 18, 2022, from Deloitte Haskins & Sells, Chartered Accountants, to include their name as required under section 26 (1) of the Companies Act, 2013 read with SEBI ICDR Regulations, in this DRHP, and as an “expert” as defined under section 2(38) of the Companies Act, 2013 to the extent and in their capacity as our Statutory Auditors, and in respect of their (i) examination report dated January 17, 2022 on our Restated Consolidated Financial Information; and (ii) their report dated January 18, 2022 on the statement of special tax benefits in this Draft Red Herring Prospectus and such consent has not been withdrawn as on the date of this DRHP. The term “experts” and consent thereof does not represent an expert or consent within the meaning under the U.S. Securities Act.

## **Particulars regarding public or rights issues by our Company during the last five years and performance *vis-à-vis* objects**

Our Company has not made any public or rights issues (as defined under the SEBI ICDR Regulations) during the five years preceding the date of this Draft Red Herring Prospectus.

## **Performance *vis-à-vis* objects – Last issue of subsidiaries or listed promoters**

Our Company does not have any listed subsidiaries or promoters.

## **Underwriting Commission, Brokerage and Selling Commission paid on previous issues of the Equity Shares**

Since this is the initial public offering of Equity Shares, no sum has been paid or is payable as commission or brokerage for subscribing to or procuring or agreeing to procure subscription for any of the Equity Shares in the five years preceding the date of this Draft Red Herring Prospectus.

## **Capital issue during the previous three years by our Company**

Other than as disclosed in “*Capital Structure-Notes to the Capital Structure*” on page 76, our Company has not undertaken a capital issue in the last three years preceding the date of this Draft Red Herring Prospectus.

## **Capital issue during the previous three years by our listed group companies, subsidiaries or associates of our Company**

Our Company does not have any associates. Further, none of our Group Companies or Subsidiaries are listed on any Stock Exchange.

## **Price information of past issues handled by the BRLMs (during the current Fiscal and two Fiscals preceding the current Fiscal)**

### **A. *Axis Capital Limited***

**1. Price information of past issues (during current financial year and two financial years preceding the current financial year) handled by Axis Capital Limited**

Sr. No.	Issue name	Issue size (₹ millions)	Issue price (₹)	Listing date	Opening price on listing date (in ₹)	+/- % change in closing price, [+/- % change in closing benchmark]- 30th calendar days from listing	+/- % change in closing price, [+/- % change in closing benchmark]- 90th calendar days from listing	+/- % change in closing price, [+/- % change in closing benchmark]- 180th calendar days from listing
1	CMS Info Systems Limited <sup>(1)</sup>	11,000.00	216.00	December 31, 2021	218.50	-	-	-
2	Supriya Lifescience Limited <sup>(1)</sup>	7,000.00	274.00	December 28, 2021	425.00	-	-	-
3	Medplus Health Services Limited <sup>*(1)</sup>	13,982.95	796.00	December 23, 2021	1,015.00	-	-	-
4	Metro Brands Limited <sup>(1)</sup>	13,675.05	500.00	December 22, 2021	436.00	-	-	-
5	C.E. Info Systems Limited <sup>(1)</sup>	10,396.06	1,033.00	December 21, 2021	1,581.00	-	-	-
6	Shriram Properties Limited <sup>§(2)</sup>	6,000.00	118.00	December 20, 2021	90.00	12.42%, [+9.02%]	-	-
7	Tega Industries Limited <sup>(2)</sup>	6,192.27	453.00	December 13, 2021	760.00	+30.70%, [+3.96%]	-	-
8	Star Health and Allied Insurance Company Limited <sup>^(2)</sup>	60,186.84	900.00	December 10, 2021	845.00	-14.78%, [+1.72%]	-	-
9	Latent View Analytics Limited <sup>@(1)</sup>	6,000.00	197.00	November 23, 2021	530.00	+153.58%, [-2.96%]	-	-
10	One 97 Communications Limited <sup>(1)</sup>	183,000.00	2,150.00	November 18, 2021	1,955.00	-38.52%, [-4.40%]	-	-

Source: www.nseindia.com and www.bseindia.com

<sup>(1)</sup>BSE as Designated Stock Exchange

<sup>(2)</sup>NSE as Designated Stock Exchange

\* Offer Price was ₹ 718.00 per equity share to Eligible Employees

§ Offer Price was ₹107.00 per equity share to Eligible Employees

^ Offer Price was ₹ 820.00 per equity share to Eligible Employees

@ Offer Price was ₹178.00 per equity share to Eligible Employees

Notes:

a. Issue Size derived from Prospectus/final post issue reports, as available.

b. The CNX NIFTY or S&P BSE SENSEX is considered as the Benchmark Index as per the Designated Stock Exchange disclosed by the respective Issuer at the time of the issue, as applicable.

c. Price on NSE or BSE is considered for all of the above calculations as per the Designated Stock Exchange disclosed by the respective Issuer at the time of the issue, as applicable.

d. In case 30th/90th/180th day is not a trading day, closing price of the previous trading day has been considered.

e. Since 30 calendar days, 90 calendar days and 180 calendar days, as applicable, from listing date has not elapsed for few of the above issues, data for same is not available.

**Summary statement of price information of past issues (during current financial year and two financial years preceding the current financial year) handled by Axis Capital Limited**

Financial Year	Total no. of IPOs	Total funds raised (₹ in millions)	Nos. of IPOs trading at discount on as on 30th calendar days from listing date			Nos. of IPOs trading at premium on as on 30th calendar days from listing date			Nos. of IPOs trading at discount as on 180th calendar days from listing date			Nos. of IPOs trading at premium as on 180th calendar days from listing date		
			Over 50%	Between 25%-50%	Less than 25%	Over 50%	Between 25%-50%	Less than 25%	Over 50%	Between 25%-50%	Less than 25%	Over 50%	Between 25%-50%	Less than 25%
2021-2022*	24	578,022.82	-	2	6	3	5	3	-	-	-	4	1	2
2020-2021	11	93,028.90	-	-	6	2	1	2	-	1	1	4	3	2
2019-2020	5	161,776.03	-	1	2	-	-	2	1	1	-	-	-	3

\* The information is as on the date of the document

The information for each of the financial years is based on issues listed during such financial year.

Note: Since 30 calendar days and 180 calendar days, as applicable, from listing date has not elapsed for few of the above issues, data for same is not available.

**B. ICICI Securities Limited**

2. **Price information of past issues (during current financial year and two financial years preceding the current financial year) handled by ICICI Securities Limited**

Sr. No.	Issue name	Issue size (₹ millions)	Issue price (₹)	Listing date	Opening price on listing date (in ₹)	+/- % change in closing price, [+/- % change in closing benchmark]- 30th calendar days from listing	+/- % change in closing price, [+/- % change in closing benchmark]- 90th calendar days from listing	+/- % change in closing price, [+/- % change in closing benchmark]- 180th calendar days from listing
1	PB Fintech Limited <sup>^^</sup>	57,097.15	980.00	November 15, 2021	1,150.00	+14.86%, [-4.33%]	NA*	NA*
2	One 97 Communications Limited <sup>^</sup>	183,000.00	2,150.00	November 18, 2021	1,955.00	-38.52%, [-4.40%]	NA*	NA*
3	Sapphire Foods India Limited <sup>^^</sup>	20,732.53	1,180.00	November 18, 2021	1,350.00	+3.69%, [-4.39%]	NA*	NA*
4	Latent View Analytics Limited <sup>^</sup>	6,000.00	197.00 <sup>(1)</sup>	November 23, 2021	530.00	+153.58%, [-2.96%]	NA*	NA*
5	Tarsons Products Limited <sup>^</sup>	10,234.74	662.00 <sup>(2)</sup>	November 26, 2021	700.00	-4.16%, [+0.03%]	NA*	NA*
6	Go Fashion (India) Limited <sup>^</sup>	10,136.09	690.00	November 30, 2021	1,316.00	+59.78%, [+1.30%]	NA*	NA*
7	Star Health and Allied Insurance Company Limited <sup>^^</sup>	60,186.84	900.00 <sup>(3)</sup>	December 10, 2021	845.00	-14.78%, [+1.72%]	NA*	NA*
8	Shriram Properties Limited <sup>^^</sup>	6,000.00	118.00 <sup>(4)</sup>	December 20, 2021	90.00	12.42%, [+9.02%]	NA*	NA*
9	Metro Brands Limited <sup>^</sup>	13,675.05	500.00	December 22, 2021	436.00	NA*	NA*	NA*
10	Supriya Lifescience Limited <sup>^</sup>	7,000.00	274.00	December 28, 2021	425.00	NA*	NA*	NA*

\*Data not available.

<sup>^</sup>BSE as designated stock exchange

<sup>^^</sup>NSE as designated stock exchange

(1) Discount of ₹ 19 per equity share offered to eligible employees. All calculations are based on Issue Price of ₹ 197.00 per equity share.

(2) Discount of ₹ 61 per equity share offered to eligible employees. All calculations are based on Issue Price of ₹ 662.00 per equity share.

(3) Discount of ₹ 80 per equity share offered to eligible employees. All calculations are based on Issue Price of ₹ 900.00 per equity share.

(4) Discount of ₹ 11 per equity share offered to eligible employees. All calculations are based on Issue Price of ₹ 118.00 per equity share.

**Summary statement of price information of past issues (during current financial year and two financial years preceding the current financial year) handled by ICICI Securities Limited**

Financial Year	Total no. of IPOs	Total funds raised (₹ in millions)	Nos. of IPOs trading at discount on as on 30 <sup>th</sup> calendar days from listing date			Nos. of IPOs trading at premium on as on 30 <sup>th</sup> calendar days from listing date			Nos. of IPOs trading at discount as on 180 <sup>th</sup> calendar days from listing date			Nos. of IPOs trading at premium as on 180 <sup>th</sup> calendar days from listing date		
			Over 50%	Between 25%-50%	Less than 25%	Over 50%	Between 25%-50%	Less than 25%	Over 50%	Between 25%-50%	Less than 25%	Over 50%	Between 25%-50%	Less than 25%
2021-22*	23	6,69,228.24	-	2	6	5	3	5	-	-	-	2	1	1
2020-21	14	1,74,546.09	-	-	5	5	2	2	-	1	3	5	3	2
2019-20	4	49,850.66	-	-	2	-	1	1	1	-	-	2	-	1

\* This data covers issues up to YTD

**Notes:**

- Data is sourced either from [www.nseindia.com](http://www.nseindia.com) or [www.bseindia.com](http://www.bseindia.com), as per the designated stock exchange disclosed by the respective Issuer Company.
- Similarly, benchmark index considered is "NIFTY 50" where NSE is the designated stock exchange and "S&P BSE SENSEX" where BSE is the designated stock exchange, as disclosed by the respective Issuer Company.  
30<sup>th</sup>, 90<sup>th</sup>, 180<sup>th</sup> calendar day from listed day have been taken as listing day plus 29, 89 and 179 calendar days, except wherever 30<sup>th</sup>, 90<sup>th</sup>, 180<sup>th</sup> calendar day is a holiday, in which case we have considered the closing data of the previous trading day.

**Website for track record of the Book Running Lead Managers**

For details regarding the track record of the Book Running Lead Managers, as specified in circular (reference CIR/MIRSD/1/2012) dated January 10, 2012, issued by SEBI, please see the websites of the Book Running Lead Managers, as set forth in the table below:

Name	Website
Axis Capital Limited	www.axiscapital.co.in
ICICI Securities Limited	www.icicisecurities.com

### Stock Market Data of Equity Shares

This being an initial public issue of the Equity Shares of our Company, the Equity Shares are not listed on any stock exchange and accordingly, no stock market data is available for the Equity Shares.

### Redressal of Investor Grievances

SEBI, by way of its circular dated March 16, 2021 (“**March 2021 Circular**”) and as amended by the circular dated June 2, 2021, has identified the need to put in place measures, in order to manage and handle investor issues arising out of the UPI Mechanism *inter alia* in relation to delay in receipt of mandates by Bidders for blocking of funds due to systemic issues faced by Designated Intermediaries/SCSBs and failure to unblock funds in cases of partial allotment/non allotment within prescribed timelines and procedures.

In terms of SEBI circular no. SEBI/HO/CFD/DIL2/CIR/P/2018/22, dated February 15, 2018, any ASBA Bidder whose Bid has not been considered for Allotment, due to failure on the part of any SCSB, shall have the option to seek redressal of the same by the concerned SCSB within three months of the date of listing of the Equity Shares. SCSBs are required to resolve these complaints within 15 days, failing which the concerned SCSB would have to pay interest at the rate of 15% per annum for any delay beyond this period of 15 days. Separately, pursuant to the March 2021 Circular, the following compensation mechanism shall be applicable for investor grievances in relation to Bids made through the UPI Mechanism for public issues opening on or after May 1, 2021, for which the relevant SCSBs shall be liable to compensate the investor:

Scenario	Compensation amount	Compensation period
Delayed unblock for cancelled / withdrawn / deleted applications	₹100 per day or 15% per annum of the Bid Amount, whichever is higher	From the date on which the request for cancellation / withdrawal / deletion is placed on the bidding platform of the Stock Exchanges till the date of actual unblock
Blocking of multiple amounts for the same Bid made through the UPI Mechanism	1. Instantly revoke the blocked funds other than the original application amount; and 2. ₹100 per day or 15% per annum of the total cumulative blocked amount except the original Bid Amount, whichever is higher	From the date on which multiple amounts were blocked till the date of actual unblock
Blocking more amount than the Bid Amount	1. Instantly revoke the difference amount, i.e., the blocked amount less the Bid Amount; and 2. ₹100 per day or 15% per annum of the difference amount, whichever is higher	From the date on which the funds to the excess of the Bid Amount were blocked till the date of actual unblock
Delayed unblock for non – Allotted/ partially Allotted applications	₹100 per day or 15% per annum of the Bid Amount, whichever is higher	From the Working Day subsequent to the finalisation of the Basis of Allotment till the date of actual unblock

Further, in the event there are any delays in resolving the investor grievance beyond the date of receipt of the complaint from the investor, for each day delayed, the BRLMs shall be liable to compensate the investor ₹100 per day or 15% per annum of the Bid Amount, whichever is higher. The compensation shall be payable for the period ranging from the day on which the investor grievance is received till the date of actual unblock.

The agreement between the Registrar to the Offer, our Company and the Selling Shareholders provides for retention of records with the Registrar to the Offer for a period of at least eight years the date of listing and commencement of trading of the Equity Shares pursuant to the Offer.

**Bidders can contact the Company Secretary and Compliance Officer and/or the Registrar to the Offer in case of any pre-Offer or post-Offer related problems such as non-receipt of letters of Allotment, non-credit of Allotted Equity Shares in the respective beneficiary account, non-receipt of refund orders or non-receipt of funds by electronic mode, etc. For all Offer related queries and for redressal of complaints, Bidders may also write to the BRLMs, in the manner provided below.**

All grievances in relation to the Bidding process may be addressed to the Registrar to the Offer with a copy to the relevant

Designated Intermediary to whom the Bid cum Application Form was submitted. The Bidder should give full details such as name of the sole or First Bidder, Bid cum Application Form number, Bidder DP ID, Client ID, UPI ID, PAN, date of the submission of Bid cum Application Form, address of the Bidder, number of the Equity Shares applied for and the name and address of the Designated Intermediary where the Bid cum Application Form was submitted by the Bidder.

All grievances relating to Bids submitted with Registered Brokers, may be addressed to the Stock Exchanges, with a copy to the Registrar to the Offer. Further, Bidders shall also enclose a copy of the Acknowledgment Slip received from the Designated Intermediaries in addition to the information mentioned hereinabove.

Anchor Investors are required to address all grievances in relation to the Offer to the BRLMs.

Further, the Bidder shall also enclose a copy of the Acknowledgment Slip duly received from the concerned Designated Intermediary in addition to the information mentioned hereinabove.

The Registrar to the Offer shall obtain the required information from the SCSBs for addressing any clarifications or grievances of ASBA Bidders. Our Company, the BRLMs and the Registrar to the Offer accept no responsibility for errors, omissions, commission or any acts of SCSBs including any defaults in complying with its obligations under applicable SEBI ICDR Regulations. Investors can contact the Company Secretary and Compliance Officer or the Registrar to the Offer in case of any pre-Offer or post-Offer related problems such as non-receipt of letters of Allotment, non-credit of allotted Equity Shares in the respective beneficiary account, non-receipt of refund intimations and non-receipt of funds by electronic mode.

### **Disposal of Investor Grievances by our Company**

Our Company shall obtain authentication on the SCORES after the filing of this Draft Red Herring Prospectus and shall comply with the SEBI circular bearing number CIR/OIAE/1/2014 dated December 18, 2014 and the SEBI circular bearing number SEBI/HO/OIAE/IGRD/CIR/P/2021/642 dated October 14, 2021 in relation to redressal of investor grievances through SCORES.

Our Company has also constituted a Stakeholders Relationship Committee to review and redress the shareholders and investor grievances such as transfer of Equity Shares, non-receipt of annual report, non-receipt of and issue of new/duplicate certificates. For more information, see “*Our Management –Corporate Governance*” on page 184.

Our Company has also appointed Amol Arvind Raje, Company Secretary of our Company, as the Compliance Officer for the Offer. For details, “*General Information- Company Secretary and Compliance Officer*” on page 69. Each of the Selling Shareholders has severally and not jointly authorized the Company Secretary and Compliance Officer of our Company and the Registrar to the Offer to deal with, on its behalf, any investor grievances received in the Offer in relation to its respective portion of the Offered Shares, and shall provide such assistance as required by our Company and the BRLMs in this regard.

Our Company has not received any investor complaint during the three years preceding the date of this Draft Red Herring Prospectus.

Further, no investor complaint in relation to our Company is pending as on the date of filing of this Draft Red Herring Prospectus. Further, as on date of this Draft Red Herring Prospectus, we do not have any listed Group Company. Our Company estimates that the average time required by our Company or the Registrar to the Offer or the relevant Designated Intermediary, for the redressal of routine investor grievances shall be 10 Working Days from the date of receipt of the complaint. In case of non-routine complaints and complaints where external agencies are involved, our Company will seek to redress these complaints as expeditiously as possible.

### **Other confirmations**

Any person connected with the Offer shall not offer any incentive, whether direct or indirect, in any manner, whether in cash or kind or services or otherwise to any person for making an application in the initial public offer, except for fees or commission for services rendered in relation to the Offer.

## SECTION VIII – OFFER RELATED INFORMATION

### TERMS OF THE OFFER

The Equity Shares being offered and Allotted pursuant to this Offer are subject to the provisions of the Companies Act, the SCRA, SCRR, SEBI ICDR Regulations, the SEBI Listing Regulations, our Memorandum and Articles of Association, the terms of this Draft Red Herring Prospectus, the Red Herring Prospectus, the Prospectus, the Abridged Prospectus, the Bid cum Application Form, the Revision Form, CAN, the Allotment Advice and other terms and conditions as may be incorporated in the Allotment Advice and other documents or certificates that may be executed in respect of this Offer. The Equity Shares shall also be subject to all applicable laws, guidelines, rules, notifications and regulations relating to the offer of capital and listing and trading of securities offered from time to time by SEBI, the GoI, the Stock Exchanges, the RoC, the RBI, and/or other authorities, as in force on the date of this Offer and to the extent applicable or such other conditions as may be prescribed by such governmental, regulatory or statutory authority while granting its approval for the Offer.

#### The Offer

The Offer comprises a Fresh Issue by our Company and an Offer for Sale by the Selling Shareholders.

Other than (a) listing fees and annual audit fees which will be borne by the Company, and (b) the fees and expenses in relation to the legal counsel to the Selling Shareholders which shall be borne by the respective Selling Shareholders, all costs, charges, fees and expenses associated with and incurred in connection with the Offer shall be shared among the Company and each of the Selling Shareholders, in proportion to the number of Equity Shares issued and Allotted through the Fresh Issue and sold by each of the Selling Shareholders in the Offer for Sale. Provided that all such expenses shall initially be borne by our Company and upon the successful completion of the Offer each of the Selling Shareholders shall reimburse the Company for respective proportion of the expenses. In the event the Offer is withdrawn or not completed for any reason whatsoever by way of mutual agreement between the Company and the Selling Shareholders or the Offer is not successful, all costs and expenses with respect to the Offer shall be borne by the Company.

#### Ranking of the Equity Shares

The Equity Shares being offered and Allotted in the Offer shall be subject to the provisions of the Companies Act, our Memorandum and Articles of Association and shall rank *pari passu* in all respects with the existing Equity Shares including rights in respect of dividend and other corporate benefits if any, declared by our Company after the date of Allotment. For further details, see “*Main Provisions of the Articles of Association*” on page 371.

#### Mode of Payment of Dividend

Our Company shall pay dividends, if declared, to Shareholders as per the provisions of the Companies Act, 2013, our Memorandum and Articles, the SEBI Listing Regulations and other applicable law. All dividends, if any, declared by our Company after the date of Allotment, will be payable to the Bidders who have been Allotted Equity Shares in the Offer, in accordance with applicable law. For further details in relation to dividends, see “*Dividend Policy*” and “*Main Provisions of the Articles of Association*” on pages 201 and 371, respectively.

#### Face Value, Offer Price and Price Band

The face value of each Equity Share is ₹ 5. The Floor Price of Equity Shares is ₹[●] per Equity Share and the Cap Price is ₹[●] per Equity Share. The Anchor Investor Offer Price is ₹[●] per Equity Share. The Price Band, Employee Discount (if any) and minimum Bid Lot for the Offer will be decided by our Company and the Selling Shareholders, in consultation with the BRLMs, and advertised in [●] editions of the English national daily newspaper [●], [●] editions of the Hindi national daily newspaper [●], and [●] editions of the Gujarati daily newspaper [●] (Gujarati being the regional language of Gujarat, where our Registered Office is located), each with wide circulation, respectively, at least two Working Days prior to the Bid/ Offer Opening Date and shall be made available to the Stock Exchanges for the purpose of uploading on their websites. The Price Band, along with the relevant financial ratios calculated at the Floor Price and at the Cap Price, shall be pre-filled in the Bid cum Application Forms available at the websites of the Stock Exchanges. The Offer Price shall be determined by our Company and the Selling Shareholders in consultation with the BRLMs, after the Bid/Offer Closing Date, on the basis of assessment of market demand for the Equity Shares offered by way of Book Building Process.

At any given point of time there shall be only one denomination for the Equity Shares.

## **Compliance with Disclosure and Accounting Norms**

Our Company shall comply with all applicable disclosure and accounting norms as specified by SEBI from time to time.

## **Rights of Shareholders**

Subject to applicable laws, rules, regulations and guidelines and the provisions of our Articles, our Shareholders shall have the following rights:

- The right to receive dividend, if declared;
- The right to attend general meetings and exercise voting powers, unless prohibited by law;
- The right to vote on a poll either in person or by proxy or 'e-voting';
- The right to receive offers for rights shares and be allotted bonus shares, if announced;
- The right to receive any surplus on liquidation subject to any statutory and other preferential claims being satisfied;
- The right to freely transfer their Equity Shares, subject to foreign exchange regulations and other applicable laws; and
- Such other rights, as may be available to a shareholder of a listed public company under applicable law, including the Companies Act, 2013, the terms of the SEBI Listing Regulations, and our Memorandum and Articles.

For a detailed description of the main provisions of our Articles relating to voting rights, dividend, forfeiture and lien, transfer and transmission, and/ or consolidation/ splitting, see "*Main Provisions of the Articles of Association*" on page 371.

## **Allotment of Equity Shares in dematerialised form**

Pursuant to Section 29 of the Companies Act, 2013, the Equity Shares shall be Allotted only in dematerialised form. Hence, the Equity Shares offered through the Red Herring Prospectus can be applied for in the dematerialised form only. In this context, our Company has entered into the following agreements:

- Tripartite agreement dated December 31, 2021, amongst our Company, NSDL and Registrar to the Offer.
- Tripartite agreement dated December 16, 2021, amongst our Company, CDSL and Registrar to the Offer.

## **Market Lot and Trading Lot**

Further, the trading of our Equity Shares on the Stock Exchanges shall only be in dematerialised form, consequent to which, the tradable lot is one Equity Share. Allotment of Equity Shares will be only in electronic form in multiples of [●] Equity Shares, subject to a minimum Allotment of [●] Equity Shares.

## **Joint Holders**

Subject to provisions contained in our Articles, where two or more persons are registered as the holders of any Equity Share, they shall be deemed to hold such Equity Shares as joint tenants with benefits of survivorship.

## **Period of operation of subscription list**

See "*Bid/Offer Programme*" on page 343.

## **Nomination facility to Bidders**

In accordance with Section 72 of the Companies Act, 2013 read with the Companies (Share Capital and Debentures) Rules, 2014, as amended, the sole or First Bidder, along with other joint Bidders, may nominate any one person in whom, in the event of the death of the sole Bidder or in case of joint Bidders, the death of all the Bidders, as the case may be, the Equity Shares Allotted, if any, shall vest to the exclusion of all other persons, unless the nomination is varied or cancelled in the prescribed manner. A person, being a nominee, entitled to the Equity Shares by reason of death of the



original holder(s), shall be entitled to the same advantages to which such person would be entitled if such person were the registered holder of the Equity Share(s). Where the nominee is a minor, the holder(s) may make a nomination to appoint, in the prescribed manner, any person to become entitled to the Equity Share(s) in the event of his or her death during the minority. A nomination shall stand rescinded upon a sale, transfer of Equity Share(s) by the person nominating. A nomination may be cancelled or varied by nominating any other person in place of the present nominee by the holder of the Equity Shares who has made the nomination by giving a notice of such cancellation. A buyer will be entitled to make a fresh nomination in the manner prescribed. A fresh nomination can be made only on the prescribed form, which is available on request at our Registered Office or with the registrar and transfer agents of our Company.

Any person who becomes a nominee by virtue of Section 72 of the Companies Act, 2013 as mentioned above, shall, upon the production of such evidence as may be required by our Board, elect either:

- to register himself or herself as the holder of the Equity Shares; or
- to make such transfer of the Equity Shares, as the deceased holder could have made.

Further, our Board may at any time give notice requiring any nominee to choose either to be registered himself or herself or to transfer the Equity Shares, and if the notice is not complied with within a period of 90 days, our Board may thereafter withhold payment of all dividends, bonuses or other monies payable in respect of the Equity Shares, until the requirements of the notice have been complied with.

Since the Allotment will be made only in dematerialised form, there shall be no requirement for a separate nomination with our Company. Nominations registered with the respective Depository Participant of the applicant will prevail. If investors wish to change their nomination, they are requested to inform their respective Depository Participant.

#### Bid/Offer Programme

<b>BID/ OFFER OPENS ON*</b>	[●]
<b>BID/ OFFER CLOSES ON**</b>	[●]^

\*Our Company and the Selling Shareholders may, in consultation with the BRLMs, allocate up to 60% of the QIB Portion to Anchor Investors on a discretionary basis, in accordance with the SEBI ICDR Regulations. Anchor Investors shall Bid on the Anchor Investor Bidding Date.

\*\*Our Company and the Selling Shareholders may, in consultation with the BRLMs, consider closing the Bid/Offer Period for QIBs one day prior to the Bid/Offer Closing Date in accordance with the SEBI ICDR Regulations.

^UPI mandate end time and date shall be at [●] on [●].

An indicative timetable in respect of the Offer is set out below:

Event	Indicative Date
Bid/Offer Closing date	[●]
Finalisation of Basis of Allotment with the Designated Stock Exchange	[●]
Initiation of refunds (if any, for Anchor Investors) / unblocking of funds from ASBA Account**	[●]
Credit of the Equity Shares to depository accounts of Allottees	[●]
Commencement of trading of the Equity Shares on the Stock Exchanges	[●]

\*\*In case of any delay in unblocking of amounts in the ASBA Accounts (including amounts blocked through the UPI Mechanism) exceeding four Working Days from the Bid/Offer Closing Date, the Bidder shall be compensated at a uniform rate of ₹100 per day for the entire duration of delay exceeding four Working Days from the Bid/Offer Closing Date by the intermediary responsible for causing such delay in unblocking. The BRLMs shall, in their sole discretion, identify and fix the liability on such intermediary or entity responsible for such delay in unblocking. For the avoidance of doubt, the provisions of the SEBI circular dated March 16, 2021, as amended pursuant to SEBI circular dated June 2, 2021 shall be deemed to be incorporated in the agreements to be entered into by and between the Company and the relevant intermediaries, to the extent applicable.

The above timetable is indicative and does not constitute any obligation on our Company, the Selling Shareholders or the BRLMs. While our Company shall ensure that all steps for the completion of the necessary formalities for the listing and the commencement of trading of the Equity Shares on the Stock Exchanges are taken within six Working Days of the Bid/Offer Closing Date or such period as may be prescribed, the timetable may change due to various factors, such as extension of the Bid/Offer Period by our Company and the Selling Shareholders, revision of the Price Band or any delays in receiving the final listing and trading approval from the Stock Exchanges. The commencement of trading of the Equity Shares will be entirely at the discretion of the Stock Exchanges and in accordance with the applicable laws. Each Selling Shareholders severally and not jointly confirm that they shall extend reasonable support and co-operation required by our Company and the BRLMs

**for the completion of the necessary formalities for listing and commencement of trading of the Equity Shares at the Stock Exchanges within six Working Days from the Bid/Offer Closing Date, or within such other period as may be prescribed by SEBI.**

**The Registrar to the Offer shall submit the details of cancelled/withdrawn/deleted applications to the SCSB's on daily basis within 60 minutes of the Bid closure time from the Bid/ Offer Opening Date till the Bid/Offer Closing Date by obtaining the same from the Stock Exchanges. The SCSBs shall unblock such applications by the closing hours of the Working Day.**

In terms of the UPI Circulars, in relation to the Offer, the Book Running Lead Managers will be required to submit reports of compliance with timelines and activities prescribed by SEBI in connection with the allotment and listing procedure within six Working Days from the Bid/Offer Closing Date, identifying nonadherence to timelines and processes and an analysis of entities responsible for the delay and the reasons associated with it.

Except in relation to the Bids received from the Anchor Investors, Bids and any revision in Bids shall be accepted **only between 10.00 a.m. and 5.00 p.m.** (Indian Standard Time ("IST")) during the Bid/Offer Period (except on the Bid/Offer Closing Date) at the Bidding Centres as mentioned on the Bid cum Application Form **except that:**

- (i) on the QIB Bid/Offer Closing Date, in case of Bids by QIBs under the QIB Portion, the Bids and the revisions in Bids shall be accepted only between 10.00 a.m. and 3.00 p.m. (Indian Standard Time) and uploaded until 4.00 p.m. (IST).
- (ii) on the Bid/Offer Closing Date:
  - (a) in case of Bids by Non-Institutional Investors, the Bids and the revisions in Bids shall be accepted only between 10.00 a.m. and 3.00 p.m. (IST) and uploaded until 4.00 p.m. (IST); and
  - (b) in case of Bids by Retail Individual Investors and Eligible Employees Bidding under the Employee Reservation Portion, the Bids and the revisions in Bids shall be accepted only between 10.00 a.m. and 3.00 p.m. (IST) and uploaded until 5.00 p.m. (IST), which may be extended up to such time as deemed fit by the Stock Exchanges after taking into account the total number of applications received up to the closure of timings and reported by the BRLMs to the Stock Exchanges.

For the avoidance of doubt, it is clarified that Bids not uploaded on the electronic bidding system or in respect of which full Bid Amount is not blocked by SCSBs will be rejected.

Due to limitation of the time available for uploading the Bids on the Bid/Offer Closing Date, the Bidders are advised to submit their Bids one day prior to the Bid/Offer Closing Date and, in any case, no later than 1.00 p.m. (Indian Standard Time) on the Bid/ Offer Closing Date. Bidders are cautioned that, in the event a large number of Bids are received on the Bid/ Offer Closing Date, as is typically experienced in public offerings in India, it may lead to some Bids not being uploaded due to lack of sufficient time to upload. Such Bids that cannot be uploaded on the electronic bidding system will not be considered for allocation under this Offer. Bids and any revision in Bids will only be accepted on Working Days. Investors may please note that as per letter no. List/smd/sm/2006 dated July 3, 2006 and letter no. NSE/IPO/25101-6 dated July 6, 2006 issued by BSE and NSE respectively, Bids and any revision in Bids shall not be accepted on Saturdays and public holidays as declared by the Stock Exchanges. Bids by ASBA Bidders shall be uploaded by the relevant Designated Intermediary in the electronic system to be provided by the Stock Exchanges.

Our Company and the Selling Shareholders, in consultation with the BRLMs, reserve the right to revise the Price Band during the Bid/ Offer Period in accordance with the SEBI ICDR Regulations. In such an event, the Cap Price shall not be more than 120% of the Floor Price, provided that the Cap Price shall be at least 105% of the Floor Price. Subject to compliance with the immediately preceding sentence, the Floor Price can move up or down to the extent of 20% of the Floor Price, as advertised at least five Working Days before the Bid/ Offer Opening Date.

**In case of any revision in the Price Band, the Bid/ Offer Period shall be extended for at least three additional Working Days after such revision of the Price Band, subject to the total Bid/ Offer Period not exceeding 10 Working Days. Any revision in the Price Band, and the revised Bid/ Offer Period, if applicable, shall be widely disseminated by notification to the Stock Exchanges by issuing a press release and also by indicating the change on the websites of the BRLMs and at the terminals of the members of the Syndicate.**

In case of discrepancy in the data entered in the electronic book *vis-à-vis* the data contained in the physical Bid cum Application Form for a particular Bidder, the details as per the Bid file received from the Stock Exchanges may be taken as the final data for the purpose of Allotment.

### **Minimum Subscription**

If our Company does not receive the minimum subscription of 90% of the Fresh Issue on the Bid/Offer Closing Date, minimum subscription in the Offer as specified under the terms of Rule 19(2)(b) of the SCRR, as applicable, on the date of closure of the Offer or withdrawal of applications; or after technical rejections; or if the listing or trading permission are not obtained from the Stock Exchanges for the Equity Shares so offered under the Offer document, our Company, shall forthwith refund the entire subscription amount received. If there is a delay beyond four days from the closure of the Offer, our Company shall pay interest at the rate of 15% per annum or such other amount prescribed under applicable law, including the SEBI circular bearing no. SEBI/HO/CFD/DIL1/CIR/P/2021/47 dated March 31, 2021. Each Selling Shareholder shall be, severally and not jointly, liable to refund money raised in the Offer, only to the extent of its respective Offered Shares, together with any interest on such amount as per Applicable Laws. No liability to make any payment of interest shall accrue to the Selling Shareholders unless any delay in making any of the payments hereunder or any delay in obtaining listing or trading approvals in relation to the Offer is solely attributable to the relevant Selling Shareholder. All refunds made, interest borne, and expenses incurred (with regard to payment of refunds) by the Company on behalf of any of the Selling Shareholders will be adjusted or reimbursed by such Selling Shareholder to the Company as agreed among the Company and the Selling Shareholders in writing, in accordance with Applicable Laws.

The requirement for minimum subscription is not applicable to the Offer for Sale portion of the Offer. In the event of under-subscription in the Offer, Allotment of valid Bids will be made in the first instance towards subscription of 90% of the Fresh Issue ("**Minimum Subscription**"), provided that post satisfaction of the Minimum Subscription, subject to receipt of any remaining valid Bids, Equity Shares will be Allotted under the Offer for Sale (a) in priority to the Offered Shares being offered by the Investor Selling Shareholder; (b) post complete satisfaction of the Investor Selling Shareholder's portion of the Offered Shares, proportionately towards the Offered Shares being offered by the Other Selling Shareholders; and (c) post complete satisfaction of the Other Selling Shareholders' portion of the Offered Shares, the balance Equity Shares shall be Allotted towards the Fresh Issue. For avoidance of doubt, it is hereby clarified that balance Equity Shares of the Fresh Issue (*i.e.*, 10% of the Fresh Issue) will be offered only once the entire portion of the Offered Shares are Allotted in the Offer. Under subscription, if any, in any category except the QIB portion, would be met with spill-over from the other categories at the discretion of our Company and the Selling Shareholders, in consultation with the Book Running Lead Managers, and the Designated Stock Exchange.

Further, our Company shall ensure that the number of prospective Allottees to whom the Equity Shares will be Allotted shall not be less than 1,000 in compliance with Regulation 49(1) of SEBI ICDR Regulations failing which the entire application money shall be unblocked in the respective ASBA Accounts of the Bidders.

### **Arrangements for disposal of odd lots**

Since our Equity Shares will be traded in dematerialised form only and the market lot for our Equity Shares will be one Equity Share, no arrangements for disposal of odd lots are required.

### **New Financial Instruments**

Our Company is not issuing any new financial instruments through this Offer.

### **Restriction on transfer and transmission of shares**

Except for the lock-in of the pre-Offer Equity Shares, the Promoter's Contribution and Equity Shares allotted to Anchor Investors pursuant to the Offer, as detailed in "*Capital Structure*" on page 76 and except as provided in our Articles, there are no restrictions on transfers and transmission of Equity Shares or on their consolidation or splitting. See, "*Main Provisions of the Articles of Association*" at page 371.

### **Option to receive Equity Shares in Dematerialized Form**

Allotment of Equity Shares to successful Bidders will only be in the dematerialized form. Bidders will not have the option of Allotment of the Equity Shares in physical form. The Equity Shares on Allotment will be traded only in the dematerialized segment of the Stock Exchanges.

### **Withdrawal of the Offer**

Our Company and the Selling Shareholders, in consultation with the BRLMs, reserves the right not to proceed with the entire or portion of the Offer for any reason at any time after the Bid/Offer Opening Date but before the Allotment. In such an event, our Company would issue a public notice in the same newspapers, in which the pre-Offer advertisements were published, within two days of the Bid/Offer Closing Date or such other time as may be prescribed by SEBI, providing reasons for not proceeding with the Offer. Further, the Stock Exchanges shall be informed promptly in this regard by our Company and the BRLMs, through the Registrar to the Offer, shall notify the SCSBs and the Sponsor Bank, in case of RIIs using the UPI Mechanism, to unblock the bank accounts of the ASBA Bidders and shall notify the Escrow Collection Bank to release the Bid Amounts to the Anchor Investors, within one Working Day from the date of receipt of such notification. Our Company shall also inform the same to the Stock Exchanges on which Equity Shares are proposed to be listed.

Notwithstanding the foregoing, the Offer is also subject to obtaining (i) the final listing and trading approvals of the Stock Exchanges, which our Company shall apply for after Allotment; and (ii) the final RoC approval of the Prospectus after it is filed with the RoC. If our Company and the Selling Shareholders, in consultation with the Book Running Lead Managers, withdraw the Offer at any stage, including after the Bid/Offer Closing Date and thereafter determine that they will proceed with a public offering of the Equity Shares, our Company shall file a fresh draft red herring prospectus with SEBI and the Stock Exchanges.

## OFFER STRUCTURE

The Offer is being made through the Book Building Process. The Offer comprises up to [●] Equity Shares, at an Offer Price of ₹ [●] per Equity Share for cash, including a premium of ₹ [●] per Equity Share, aggregating up to ₹ 7,620.00 million, comprising of up to [●] Equity Shares aggregating up to ₹ 1,500.00 million through Fresh Issue by our Company and an Offer for Sale of up to [●] Equity Shares by the Selling Shareholders aggregating up to ₹ 6,120.00 million.

The Offer comprises a Net Offer of up to [●] Equity Shares and Employee Reservation Portion of up to [●]\* Equity Shares. The Employee Reservation Portion shall not exceed [●]% of our post-Offer paid-up Equity Share capital. The Offer and the Net Offer shall constitute [●]% and [●]%, respectively of the post-Offer paid-up Equity Share capital of our Company. The face value of each Equity Share is ₹ 5 each.

*\*A discount of up to [●]% to the Offer Price (equivalent of ₹[●] per Equity Share may be offered to Eligible Employees bidding in the Employee Reservation Portion in accordance with the SEBI ICDR Regulations and details of which will be announced at least two Working Days prior to the Bid / Offer Opening Date*

Particulars	Eligible Employees <sup>#</sup>	QIBs <sup>(1)</sup>	Non-Institutional Investors	Retail Individual Investors
Number of Equity Shares available for Allotment/ allocation* <sup>(2)</sup>	Not more than [●] Equity Shares	Not more than [●] Equity Shares or Net Offer less allocation to Non-Institutional Investors and Retail Individual Investors	Not less than [●] Equity Shares available for allocation or Offer less allocation to QIB Bidders and Retail Individual Investors	Not less than [●] Equity Shares available for allocation or Offer less allocation to QIB Bidders and Non-Institutional Investors
Percentage of Offer Size available for Allotment/ allocation	The Employee Reservation Portion shall constitute up to [●]% of the post-Offer Equity Share capital of our Company	Not more than 50% of the Net Offer shall be allocated to QIB Bidders. However, up to 5% of the Net QIB Portion (will be available for allocation proportionately to Mutual Funds only. Mutual Funds participating in the Mutual Fund Portion will also be eligible for allocation in the remaining Net QIB Portion. The unsubscribed portion in the Mutual Fund Portion will be added to the Net QIB Portion	Not less than 15% of the Net Offer, or the Offer less allocation to QIB Bidders and Retail Individual Investors.	Not less than 35% of the Net Offer, or the Offer less allocation to QIB Bidders and Non-Institutional Investors
Basis of Allotment/ allocation if respective category is oversubscribed*	Proportionate <sup>#</sup> ; unless the Employee Reservation Portion is undersubscribed, the value of allocation to an Eligible Employee shall not exceed ₹ 200,000. In the event of undersubscription in the Employee Reservation Portion, the unsubscribed	Proportionate as follows (excluding the Anchor Investor Portion): (a) Up to [●] Equity Shares shall be available for allocation on a proportionate basis to Mutual Funds only; and (b) [●] Equity Shares shall be Allotted on a proportionate	Proportionate	The allotment to each Retail Individual Investor shall not be less than the minimum Bid Lot, subject to availability of Equity Shares in the Retail Portion and the remaining available Equity Shares if any, shall be allotted on a proportionate basis.

Particulars	Eligible Employees <sup>#</sup>	QIBs <sup>(1)</sup>	Non-Institutional Investors	Retail Individual Investors
	portion may be Allocated, on a proportionate basis, to Eligible Employees for a value exceeding ₹ 200,000, subject to total Allotment to an Eligible Employee not exceeding ₹500,000.	basis to all QIBs, including Mutual Funds receiving allocation as per (a) above  Up to [●] Equity Shares may be allocated on a discretionary basis to Anchor Investors of which one-third shall be available for allocation to Mutual Funds only, subject to valid Bid received from Mutual Funds at or above the Anchor Investor Allocation Price		For details, see "Offer Procedure" on page 351.
Minimum Bid	[●] Equity Shares and in multiples of [●] Equity Shares thereafter	Such number of Equity Shares and in multiples of [●] Equity Shares, thereafter that the Bid Amount exceeds ₹ 200,000	Such number of Equity Shares and in multiples of [●] Equity Shares thereafter that the Bid Amount exceeds ₹ 200,000	[●] Equity Shares and in multiples of [●] Equity Shares thereafter
Maximum Bid	Such number of Equity Shares in multiples of [●] Equity Shares, so that the maximum Bid Amount by each Eligible Employee in Eligible Employee Portion does not exceed ₹ 500,000	Such number of Equity Shares in multiples of [●] Equity Shares not exceeding the size of the Offer, subject to applicable limits	Such number of Equity Shares in multiples of [●] Equity Shares not exceeding the size of the Offer (excluding the QIB Portion), subject to limits prescribed under applicable law	Such number of Equity Shares in multiples of [●] Equity Shares so that the Bid Amount does not exceed ₹ 200,000
Bid Lot	[●] Equity Shares and in multiples of [●] Equity Shares thereafter			
Mode of allotment	Compulsorily in dematerialised form			
Allotment Lot	[●] Equity Shares and in multiples of one Equity Share thereafter			
Trading Lot	One Equity Share			
Who can apply <sup>(3)</sup>	Eligible Employees (such that the Bid Amount does not exceed ₹ 500,000)	Public financial institutions (as specified in Section 2(72) of the Companies Act), scheduled commercial banks, Mutual Funds, Eligible FPIs, VCFs, AIFs, FVCIs registered with SEBI, multilateral and bilateral development financial institutions, state industrial development corporation, insurance companies registered with IRDAI, provident funds (subject to applicable law) with minimum corpus of ₹250 million, pension	Resident Indian individuals, Eligible NRIs, HUFs (in the name of the karta), companies, corporate bodies, scientific institutions societies and trusts and any individuals, corporate bodies and family offices which are recategorized as category II FPIs and registered with SEBI	Resident Indian individuals, Eligible NRIs and HUFs (in the name of the karta)

Particulars	Eligible Employees <sup>#</sup>	QIBs <sup>(1)</sup>	Non-Institutional Investors	Retail Individual Investors
		funds with minimum corpus of ₹250 million, National Investment Fund set up by the Government of India, the insurance funds set up and managed by army, navy or air force of the Union of India, insurance funds set up and managed by the Department of Posts, India and Systemically Important Non-Banking Financial Companies.		
Terms of Payment	<p><b>In case of Anchor Investors:</b> Full Bid Amount shall be payable by the Anchor Investors at the time of submission of their Bids<sup>(4)</sup></p> <p><b>In case of all other Bidders:</b> Full Bid Amount shall be blocked by the SCSBs in the bank account of the ASBA Bidder (other than Anchor Investors) or by the Sponsor Bank through the UPI Mechanism (for RIIs), that is specified in the ASBA Form at the time of submission of the ASBA Form.</p>			
Mode of Bidding	Only through the ASBA process (except for Anchor Investors).			

\* Assuming full subscription in the Offer

<sup>#</sup> Eligible Employees Bidding in the Employee Reservation Portion can Bid up to a Bid Amount of ₹ 200,000. However, a Bid by an Eligible Employee in the Employee Reservation Portion will be considered for allocation, in the first instance, for a Bid Amount of up to ₹ 200,000. In the event of under-subscription in the Employee Reservation Portion the unsubscribed portion will be available for allocation and Allotment, proportionately to all Eligible Employees who have Bid in excess of ₹ 200,000, subject to the maximum value of Allotment made to such Eligible Employee not exceeding ₹ 500,000. Further, an Eligible Employee Bidding in the Employee Reservation Portion can also Bid in the Net Offer and such Bids will not be treated as multiple Bids subject to applicable limits. Furthermore, an Eligible Employee Bidding in the Employee Reservation Portion shall be added back to the Net Offer. In case of under-subscription in the Net Offer, spill-over to the extent of such under-subscription shall be permitted from the Employee Reservation Portion.

<sup>(1)</sup> Our Company and the Selling Shareholders may, in consultation with the BRLMs, allocate up to 60% of the QIB Portion to Anchor Investors on a discretionary basis in accordance with the SEBI ICDR Regulations. One-third of the Anchor Investor Portion shall be reserved for domestic Mutual Funds, subject to valid Bids being received from domestic Mutual Funds at or above the Anchor Investor Allocation Price. In the event of under-subscription or non-Allotment in the Anchor Investor Portion, the balance Equity Shares in the Anchor Investor Portion shall be added to the QIB Portion. For further details, see "Offer Procedure" on page 351.

<sup>(2)</sup> Subject to valid Bids being received at or above the Offer Price. The Offer is being made in terms of Rule 19(2)(b) of the SCRR read with Regulation 45 of the SEBI ICDR Regulations.

Subject to valid Bids being received at or above the Offer Price, under-subscription, if any, in the Non-Institutional Portion or the Retail Portion would be allowed to be met with spill-over from other categories or a combination of categories at the discretion of our Company and the Selling Shareholders, in consultation with the BRLMs and the Designated Stock Exchange, on a proportionate basis. However, under-subscription, if any, in the QIB Portion will not be allowed to be met with spill-over from other categories or a combination of categories. For further details, please see "Terms of the Offer" on page 341.

<sup>(3)</sup> In the event that a Bid is submitted in joint names, the relevant Bidders should ensure that the depository account is also held in the same joint names and the names are in the same sequence in which they appear in the Bid cum Application Form. The Bid cum Application Form should contain only the name of the First Bidder whose name should also appear as the first holder of the beneficiary account held in joint names. The signature of only such First Bidder would be required in the Bid cum Application Form and such First Bidder would be deemed to have signed on behalf of the joint holders. Our Company reserves the right to reject, in its absolute discretion, all or any multiple Bids in any or all categories.

<sup>(4)</sup> Anchor Investors shall pay the entire Bid Amount at the time of submission of the Anchor Investor Bid, provided that any positive difference between the Anchor Investor Allocation Price and the Offer Price, shall be payable by the Anchor Investor Pay-in Date as mentioned in the CAN.

**Note: Bidders will be required to confirm and will be deemed to have represented to our Company, the Selling Shareholders, the Underwriters, their respective directors, officers, agents, affiliates and representatives that they are eligible under applicable law, rules, regulations, guidelines and approvals to acquire the Equity Shares.**

Eligible Employees bidding in the Employee Reservation Portion at a price within the Price Band can make payment based on Bid Amount net of Employee Discount, at the time of making a Bid. Eligible Employees bidding in the Employee Reservation Portion at the Cut-Off Price have to ensure payment at the Cap Price, less Employee Discount, if any, at the time of making a Bid.

Subject to valid Bids being received at or above the Offer Price, undersubscription, if any, in any category except the QIB Portion, would be met with spill-over from the other categories or a combination of categories at the discretion of our Company in consultation with the BRLMs, and the Designated Stock Exchange.



## OFFER PROCEDURE

All Bidders should read the General Information Document for Investing in Public Offers prepared and issued in accordance with the circular no. SEBI/HO/CFD/DIL1/CIR/P/2020/37 dated March 17, 2020 and the UPI Circulars (the “**General Information Document**”) which highlights the key rules, processes and procedures applicable to public issues in general in accordance with the provisions of the Companies Act, the SCRA, the SCRR and the SEBI ICDR Regulations which is part of the abridged prospectus accompanying the Bid cum Application Form. The General Information Document is available on the websites of the Stock Exchanges and the BRLMs. Please refer to the relevant provisions of the General Information Document which are applicable to the Offer.

Bidders may refer to the General Information Document for information in relation to (i) category of investors eligible to participate in the Offer; (ii) maximum and minimum Bid size; (iii) price discovery and allocation; (iv) payment instructions for ASBA Bidders; (v) issuance of Confirmation of Allocation Note (“**CAN**”) and Allotment in the Offer; (vi) general instructions (limited to instructions for completing the Bid cum Application Form); (vii) designated date; (viii) disposal of applications and electronic registration of bids; (ix) submission of Bid cum Application Form; (x) other instructions (limited to joint bids in cases of individual, multiple bids and instances when an application would be rejected on technical grounds); (xi) applicable provisions of Companies Act relating to punishment for fictitious applications; (xii) mode of making refunds; and (xiii) interest in case of delay in Allotment or refund.

SEBI through the UPI Circulars has proposed to introduce an alternate payment mechanism using Unified Payments Interface (“**UPI**”) and consequent reduction in timelines for listing in a phased manner. UPI has been introduced in a phased manner as a payment mechanism in addition to ASBA for applications by Retail Individual Investors through intermediaries from January 1, 2019. The UPI Mechanism for Retail Individual Investors applying through Designated Intermediaries, in phase I, was effective along with the prior process and existing timeline of T+6 days (“**UPI Phase I**”), until June 30, 2019. Subsequently from July 1, 2019, for applications by Retail Individual Investors through Designated Intermediaries, the process of physical movement of forms from Designated Intermediaries to SCSBs for blocking of funds has been discontinued and RIIs submitting their ASBA Forms through Designated Intermediaries (other than SCSBs) can only use UPI Mechanism with existing timeline of T+6 days until further notice pursuant to SEBI circular (SEBI/HO/CFD/DIL2/CIR/P/2020/50) dated March 30, 2020 (“**UPI Phase II**”). The final reduced timeline will be made effective using the UPI Mechanism for applications by Retail Individual Investors (“**UPI Phase III**”), as may be prescribed by SEBI. The Offer will be made under UPI Phase II of the UPI Circular, subject to any circulars, clarification or notification issued by the SEBI from time to time. Further, SEBI vide its circular no. SEBI/HO/CFD/DIL2/CIR/P/2021/2480/1/M dated March 16, 2021 has introduced certain additional measures for streamlining the process of initial public offers and redressing investor grievances. This circular shall come into force for initial public offers opening on or after May 1, 2021 except as amended pursuant to SEBI circular dated June 2, 2021, and the provisions of this circular, as amended, are deemed to form part of this Draft Red Herring Prospectus.

In terms of Regulation 23(5) and Regulation 52 of SEBI ICDR Regulations, the timelines and processes mentioned in SEBI Circular No. SEBI/HO/CFD/DCR2/CIR/P/2019/133 dated November 8, 2019 shall continue to form part of the agreements being signed between the intermediaries involved in the public issuance process and lead managers shall continue to coordinate with intermediaries involved in the said process.

Further, our Company, the Selling Shareholders and the Syndicate do not accept any responsibility for the completeness and accuracy of the information stated in this section and are not liable for any amendment, modification or change in the applicable law which may occur after the date of this Draft Red Herring Prospectus. Bidders are advised to make their independent investigations and ensure that their Bids are submitted in accordance with applicable laws and do not exceed the investment limits or maximum number of Equity Shares that can be held by them under applicable law or as specified in the Red Herring Prospectus and the Prospectus.

Our Company and the Syndicate are not liable for any adverse occurrences consequent to the implementation of the UPI Mechanism for application in this Offer.

### Book Building Procedure

The Offer is being made in terms of Rule 19(2)(b) of the SCRR through the Book Building Process in accordance with Regulation 6(1) of the SEBI ICDR Regulations wherein not more than 50% of the Net Offer shall be available for allocation to QIBs on a proportionate basis, provided that our Company and the Selling Shareholders in consultation with the BRLMs may allocate up to 60% of the QIB Portion to Anchor Investors on a discretionary basis in accordance with the SEBI ICDR Regulations, of which one-third shall be reserved for domestic Mutual Funds, subject to valid Bids being received from them at or above the Anchor Investor Allocation Price. Further, in the event of under-subscription, or non-

allocation in the Anchor Investor Portion, the balance Equity Shares shall be added to the Net QIB Portion. 5% of the Net QIB Portion shall be available for allocation on a proportionate basis to Mutual Funds only, and the remainder of the QIB Portion shall be available for allocation on a proportionate basis to all QIB Bidders, including Mutual Funds, subject to valid Bids being received at or above the Offer Price. Further, not less than 15% of the Net Offer shall be available for allocation on a proportionate basis to Non-Institutional Investors and not less than 35% of the Net Offer shall be available for allocation to Retail Individual Investors in accordance with the SEBI ICDR Regulations, subject to valid Bids being received at or above the Offer Price.

Furthermore, up to [●] Equity Shares, aggregating up to ₹ [●] million shall be made available for allocation on a proportionate basis only to Eligible Employees Bidding in the Employee Reservation Portion, subject to valid Bids being received at or above the Offer Price, if any.

Under-subscription, if any, in any category including Employee Reservation Portion, except in the QIB Portion, would be allowed to be met with spill over from any other category or combination of categories of Bidders, as applicable, at the discretion of our Board or the IPO Committee and the Selling Shareholders, as applicable, in consultation with the BRLMs and the Designated Stock Exchange subject to receipt of valid Bids received at or above the Offer Price. Under-subscription, if any, in the QIB Portion, would not be allowed to be met with spill-over from any other category or a combination of categories. Further, in the event of an under-subscription in the Employee Reservation Portion, such unsubscribed portion may be Allotted on a proportionate basis to Eligible Employees Bidding in the Employee Reservation Portion, for a value in excess of ₹ 200,000 subject to the total Allotment to an Eligible Employee not exceeding ₹ 50,000. The unsubscribed portion, if any, in the Employee Reservation Portion shall be added to the Net Offer.

The Equity Shares, on Allotment, shall be traded only in the dematerialized segment of the Stock Exchanges.

**Bidders should note that the Equity Shares will be Allotted to all successful Bidders only in dematerialized form. The Bid cum Application Forms which do not have the details of the Bidders' depository account, including the DP ID and the Client ID and the PAN and UPI ID (for Retail Individual Investors Bidding through the UPI Mechanism and Eligible Employees Bidding in the Employee Reservation Portion Bidding using the UPI Mechanism), shall be treated as incomplete and will be rejected. Bidders will not have the option of being Allotted Equity Shares in physical form.**

#### **Phased implementation of UPI for Bids by RIIs as per the UPI Circulars**

SEBI has issued UPI Circulars in relation to streamlining the process of public issue of equity shares and convertibles by introducing an alternate payment mechanism using UPI. Pursuant to the UPI Circulars, UPI has been introduced in a phased manner as a payment mechanism (in addition to mechanism of blocking funds in the account maintained with SCSBs under the ASBA) for applications by RIIs through intermediaries with the objective to reduce the time duration from public issue closure to listing from six Working Days to up to three Working Days. Considering the time required for making necessary changes to the systems and to ensure complete and smooth transition to the UPI payment mechanism, the UPI Circulars have introduced and implemented the UPI payment mechanism in three phases in the following manner:

- (a) **Phase I:** This phase was applicable from January 1, 2019 until March 31, 2019 or floating of five main board public issues, whichever was later. Subsequently, the timeline for implementation of Phase I was extended until June 30, 2019. Under this phase, an RII also had the option to submit the ASBA Form with any of the intermediary and use his / her UPI ID for the purpose of blocking of funds. The time duration from public issue closure to listing would continue to be six Working Days.
- (b) **Phase II:** This phase has become applicable from July 1, 2019 and was to initially continue for a period of three months or floating of five main board public issues, whichever is later. SEBI vide its circular no. SEBI/HO/CFD/DCR2/CIR/P/2019/133 dated November 8, 2019 has decided to extend the timeline for implementation of UPI Phase II until March 31, 2020. Under this phase, submission of the physical ASBA Form by an RII through Designated Intermediaries (other than SCSBs) to SCSBs for blocking of funds has been discontinued and is replaced by the UPI payment mechanism. However, the time duration from public issue closure to listing continues to be six Working Days during this phase. Subsequently, SEBI vide its circular no. SEBI/HO/CFD/DIL2/CIR/P/2020/50 dated March 30, 2020 extended the timeline for implementation of UPI Phase II till further notice.

(c) **Phase III:** The commencement period of Phase III is yet to be notified. In this phase, the time duration from public issue closure to listing would be reduced to be three Working Days.

All SCSBs offering facility of making application in public issues shall also provide facility to make application using UPI.

Our Company will be required to appoint one SCSB investors and directly or indirectly, having common ownership of more than 50% as the Sponsor Bank to act as a conduit between the Stock Exchanges and NPCI in order to facilitate collection of requests and / or payment instructions of the RIIs using the UPI Mechanism.

### **Bid cum Application Form**

Copies of the Bid cum Application Form (other than for Anchor Investors) and the abridged prospectus will be available with the Designated Intermediaries at relevant Bidding Centres, at our Registered Office and Corporate Office. An electronic copy of the ASBA Form will also be available for download on the websites of NSE ([www.nseindia.com](http://www.nseindia.com)) and BSE ([www.bseindia.com](http://www.bseindia.com)) at least one day prior to the Bid/Offer Opening Date.

Anchor Investor Application Forms will be available at the offices of the BRLMs.

All Bidders (other than Anchor Investors) must compulsorily use the ASBA process to participate in the Offer. Anchor Investors are not permitted to participate in this Offer through the ASBA process.

Bidders (other than Anchor Investors and Retail Individual Investors Bidding using the UPI Mechanism) must provide bank account details and authorisation by the ASBA account holder to block funds in their respective ASBA Accounts in the relevant space provided in the Bid cum Application Form and the Bid cum Application Form that does not contain such details are liable to be rejected.

Investors must ensure that their PAN is linked with Aadhaar and are in compliance with CBDT notification dated February 13, 2020 and press release dated June 25, 2021.

The processing fees for applications made by Retail Individual Investors using the UPI Mechanism may be released to the SCSBs only after such banks provide a written confirmation on compliance with SEBI circular no. SEBI/HO/CFD/DIL2/P/CIR/2021/570 dated June 2, 2021, read with SEBI circular no. SEBI/HO/CFD/DIL2/P/2021/2480/1/M dated March 16, 2021.

Retail Individual Investors submitting their Bid cum Application Form to any Designated Intermediary (other than SCSBs) shall be required to Bid using the UPI Mechanism and must provide the UPI ID in the relevant space provided in the Bid cum Application Form. Bids submitted by Retail Individual Investors with any Designated Intermediary (other than SCSBs) without mentioning the UPI ID are liable to be rejected. Retail Individual Investors Bidding using the UPI Mechanism may also apply through the SCSBs and mobile applications using the UPI handles as provided on the website of SEBI.

Further, ASBA Bidders shall ensure that the Bids are submitted at the Bidding Centres only on ASBA Forms bearing the stamp of a Designated Intermediary (except in case of electronic ASBA Forms) and ASBA Forms not bearing such specified stamp maybe liable for rejection. RIIs using UPI Mechanism, shall submit their ASBA Forms with the Syndicate, Sub-Syndicate members, Registered Brokers, CRTAs or CDPs. RIIs authorising an SCSB to block the Bid Amount in the ASBA Account may submit their ASBA Forms with the SCSBs. Bidders, using the ASBA process to participate in the Offer, must ensure that the ASBA Account has sufficient credit balance such that an amount equivalent to the full Bid Amount can be blocked therein by the SCSB or the Sponsor Bank, as applicable at the time of submitting the Bid.

The prescribed colour of the Bid cum Application Forms for various categories is as follows:

<b>Category</b>	<b>Colour of Bid cum Application Form*</b>
Resident Indians including resident QIBs, Non-Institutional Investors, Retail Individual Investors and Eligible NRIs applying on a non-repatriation basis	[●]
Non-Residents including FPIs, Eligible NRIs applying on a repatriation basis, FVCIs and registered bilateral and multilateral institutions	[●]
Anchor Investors	[●]

Category	Colour of Bid cum Application Form*
Eligible Employees Bidding in the Employee Reservation Portion	●

\* Excluding electronic Bid cum Application Forms

Notes:

(1) Electronic Bid cum Application forms will also be available for download on the website of NSE ([www.nseindia.com](http://www.nseindia.com)) and BSE ([www.bseindia.com](http://www.bseindia.com)).

(2) Bid cum Application Forms for Anchor Investors will be made available at the offices of the BRLMs.

In case of ASBA Forms, the relevant Designated Intermediaries shall upload the relevant Bid details in the electronic bidding system of the Stock Exchanges. Designated Intermediaries (other than SCSBs) shall submit/deliver the ASBA Forms (except Bid cum Application Forms submitted by Retail Individual Investors Bidding using the UPI Mechanism) to the respective SCSB, where the Bidder has a bank account and shall not submit it to any non-SCSB bank or any Escrow Collection Bank(s). For Retail Individual Investors using the UPI Mechanism, the Stock Exchanges shall share the Bid details (including UPI ID) with the Sponsor Bank on a continuous basis to enable the Sponsor Bank to initiate a UPI Mandate Request to such Retail Individual Investors for blocking of funds. The Sponsor Bank shall initiate request for blocking of funds through NPCI to RIIs, who shall accept the UPI Mandate Request for blocking of funds on their respective mobile applications associated with UPI ID linked bank account. The NPCI shall maintain an audit trail for every Bid entered in the Stock Exchanges bidding platform, and the liability to compensate RIIs (Bidding through UPI Mechanism) in case of failed transactions shall be with the concerned entity (i.e., the Sponsor Bank, NPCI or the issuer bank) at whose end the lifecycle of the transaction has come to a halt. The NPCI shall share the audit trail of all disputed transactions/ investor complaints to the Sponsor Bank and the issuer bank. The Sponsor Bank and the Bankers to the Offer shall provide the audit trail to the BRLMs for analysing the same and fixing liability.

The Sponsor Bank will undertake a reconciliation of Bid responses received from Stock Exchanges and sent to NPCI and will also ensure that all the responses received from NPCI are sent to the Stock Exchanges platform with detailed error code and description, if any. Further, the Sponsor Bank will undertake reconciliation of all Bid requests and responses throughout their lifecycle on daily basis and share reports with the BRLMs in the format and within the timelines as specified under the UPI Circulars. Sponsor Bank and issuer banks shall download UPI settlement files and raw data files from the NPCI portal after every settlement cycle and do a three way reconciliation with Banks UPI switch data, CBS data and UPI raw data. NPCI is to coordinate with issuer banks and Sponsor Banks on a continuous basis.

### Electronic registration of Bids

- The Designated Intermediary may register the Bids using the on-line facilities of the Stock Exchanges. The Designated Intermediaries can also set up facilities for off-line electronic registration of Bids, subject to the condition that they may subsequently upload the off-line data file into the on-line facilities for Book Building on a regular basis before the closure of the Offer.
- On the Bid/Offer Closing Date, the Designated Intermediaries may upload the Bids till such time as may be permitted by the Stock Exchanges and as disclosed in the Red Herring Prospectus.
- Only Bids that are uploaded on the Stock Exchanges Platform are considered for allocation/Allotment. The Designated Intermediaries are given till 1:00 pm on the next Working Day following the Bid/Offer Closing Date to modify select fields uploaded in the Stock Exchange Platform during the Bid/Offer Period after which the Stock Exchange(s) send the bid information to the Registrar to the Offer for further processing.

### Participation by the Promoter, Promoter Group, the BRLMs, associates and affiliates of the BRLMs and the Syndicate Members and the persons related to Promoter, Promoter Group, BRLMs and the Syndicate Members

The BRLMs and the Syndicate Members shall not be allowed to purchase the Equity Shares in any manner, except towards fulfilling their underwriting obligations. However, the respective associates and affiliates of the BRLMs and the Syndicate Members may purchase Equity Shares in the Offer, either in the QIB Portion or in the Non-Institutional Category as may be applicable to such Bidders, where the allocation is on a proportionate basis and such subscription may be on their own account or on behalf of their clients. All categories of investors, including respective associates or affiliates of the BRLMs and Syndicate Members, shall be treated equally for the purpose of allocation to be made on a proportionate basis.

Except for Mutual Funds, AIFs or FPIs other than individuals, corporate bodies and family offices sponsored by entities which are associates of the BRLMs or insurance companies promoted by entities which are associates of the BRLMs, no BRLMs or its respective associates can apply in the Offer under the Anchor Investor Portion.

Further, an Anchor Investor shall be deemed to be an “associate of the Lead Manager” if: (i) either of them controls, directly or indirectly through its subsidiary or holding company, not less than 15% of the voting rights in the other; or (ii) either of them, directly or indirectly, by itself or in combination with other persons, exercises control over the other; or (iii) there is a common director, excluding nominee director, amongst the Anchor Investors and the BRLMs.

Further, the Promoter and members of the Promoter Group shall not participate by applying for Equity Shares in the Offer, except in accordance with the applicable law. Furthermore, persons related to the Promoter and the Promoter Group shall not apply in the Offer under the Anchor Investor Portion. It is clarified that a qualified institutional buyer who has rights under a shareholders agreement or voting agreement entered into with any of the Promoter or members of the Promoter Group of our Company, veto rights or a right to appoint any nominee director on our Board, shall be deemed to be a person related to the Promoter or Promoter Group of our Company.

### **Bids by Anchor Investors**

In accordance with the SEBI ICDR Regulations, in addition to details and conditions mentioned in this section the key terms for participation by Anchor Investors are provided below.

- (i) Anchor Investor Application Forms will be made available for the Anchor Investor Portion at the offices of the BRLMs.
- (ii) The Bid must be for a minimum of such number of Equity Shares so that the Bid Amount exceeds ₹100 million. A Bid cannot be submitted for over 60% of the QIB Portion. In case of a Mutual Fund, separate Bids by individual schemes of a Mutual Fund will be aggregated to determine the minimum application size of ₹100 million.
- (iii) One-third of the Anchor Investor Portion will be reserved for allocation to domestic Mutual Funds.
- (iv) Bidding for Anchor Investors will open one Working Day before the Bid/Offer Opening Date, i.e., the Anchor Investor Bidding Date, and will be completed on the same day.
- (v) Our Company in consultation with the BRLMs may finalise allocation to the Anchor Investors on a discretionary basis, provided that the minimum number of Allottees in the Anchor Investor Portion will not be less than:
  - (a) maximum of two Anchor Investors, where allocation under the Anchor Investor Portion is up to ₹100 million
  - (b) minimum of two and maximum of 15 Anchor Investors, where the allocation under the Anchor Investor Portion is more than ₹100 million but up to ₹2,500 million, subject to a minimum Allotment of ₹50 million per Anchor Investor; and
  - (c) in case of allocation above ₹2,500 million under the Anchor Investor Portion, a minimum of five such investors and a maximum of 15 Anchor Investors for allocation up to ₹2,500 million, and an additional 10 Anchor Investors for every additional ₹2,500 million, subject to minimum Allotment of ₹50 million per Anchor Investor.
- (vi) Allocation to Anchor Investors will be completed on the Anchor Investor Bidding Date. The number of Equity Shares allocated to Anchor Investors and the price at which the allocation is made will be made available in the public domain by the BRLMs before the Bid/Offer Opening Date, through intimation to the Stock Exchange.
- (vii) Anchor Investors cannot withdraw or lower the size of their Bids at any stage after submission of the Bid.
- (viii) If the Offer Price is greater than the Anchor Investor Allocation Price, the additional amount being the difference between the Offer Price and the Anchor Investor Allocation Price will be payable by the Anchor Investors on the Anchor Investor Pay-in Date specified in the CAN. If the Offer Price is lower than the Anchor Investor Allocation Price, Allotment to successful Anchor Investors will be at the higher price, i.e., the Anchor Investor Allocation Price shall still be the Anchor Investor Offer Price.
- (ix) Equity Shares Allotted in the Anchor Investor Portion will be locked in for a period of 30 days from the date of Allotment.
- (x) Neither the BRLMs or any associate of the BRLMs (except Mutual Funds sponsored by entities which are

associates of the BRLMs or insurance companies promoted by entities which are associate of BRLMs or AIFs sponsored by the entities which are associate of the BRLMs or FPIs, other than individuals, corporate bodies or family offices sponsored by the entities which are associate of the BRLMs) nor any “person related to the Promoter or Promoter Group” shall apply in the Offer under the Anchor Investor Portion.

- (xi) Bids made by QIBs under both the Anchor Investor Portion and the QIB Portion will not be considered multiple Bids.
- (xii) For more information, see the General Information Document.

### **Bids by Eligible Employees**

The Bid must be for a minimum of [●] Equity Shares and in multiples of [●] Equity Shares thereafter so as to ensure that the Bid Amount payable by the Eligible Employee does not exceed ₹ 500,000 on a net basis. However, the initial allocation to an Eligible Employee in the Employee Reservation Portion shall not exceed ₹ 200,000. Allotment in the Employee Reservation Portion will be as detailed in the section “*Offer Structure*” on page 347.

However, Allotments to Eligible Employees in excess of ₹ 200,000 shall be considered on a proportionate basis, in the event of undersubscription in the Employee Reservation Portion, subject to the total Allotment to an Eligible Employee not exceeding ₹ 500,000. Subsequent undersubscription, if any, in the Employee Reservation Portion shall be added back to the Net Offer. Eligible Employees Bidding in the Employee Reservation Portion may Bid at the Cut-off Price.

Bids under the Employee Reservation Portion by Eligible Employees shall be:

- Made only in the prescribed Bid cum Application Form or Revision Form (i.e. [●] form).
- Only Eligible Employees (excluding such other persons not eligible under applicable laws, rules, regulations and guidelines) would be eligible to apply in this Offer under the Employee Reservation Portion.
- In case of joint bids, the sole/ First Bidder shall be the Eligible Employee.
- Bids by Eligible Employees may be made at Cut-off Price.
- Only those Bids, which are received at or above the Offer Price would be considered for allocation under this portion.
- The Bids must be for a minimum of [●] Equity Shares and in multiples of [●] Equity Shares thereafter so as to ensure that the Bid Amount payable by the Eligible Employee subject to a maximum Bid Amount of ₹ 500,000 on a net basis.
- If the aggregate demand in this portion is less than or equal to [●] Equity Shares at or above the Offer Price, full allocation shall be made to the Eligible Employees to the extent of their demand.
- Bids by Eligible Employees in the Employee Reservation Portion and in the Net Offer portion shall not be treated as multiple Bids. Our Company reserves the right to reject, in its absolute discretion, all or any multiple Bids in any or all categories.

In the event of under-subscription in the Employee Reservation Portion, the unsubscribed portion will be available for allocation and Allotment, proportionately to all Eligible Employees who have Bid in excess of ₹ 200,000, subject to the maximum value of Allotment made to such Eligible Employee not exceeding ₹ 500,000.

If the aggregate demand in this portion is greater than [●] Equity Shares at or above the Offer Price, the allocation shall be made on a proportionate basis. For the method of proportionate basis of Allotment, see “*Offer Procedure*” on page 351.

**The above information is given for the benefit of the Bidders. Our Company, the Selling Shareholders, the BRLMs are not liable for any amendments or modification or changes in applicable laws or regulations, which may occur after the date of this Draft Red Herring Prospectus. Bidders are advised to make their independent investigations and ensure that any single Bid from them does not exceed the applicable investment limits or maximum number of the Equity Shares that can be held by them under applicable law or regulation or as specified in this Draft Red Herring Prospectus, or as will be specified in the Red Herring Prospectus and the Prospectus.**

In accordance with existing regulations issued by the RBI, OCBs cannot participate in this Offer.

### **Bids by Mutual Funds**

With respect to Bids by Mutual Funds, a certified copy of their SEBI registration certificate must be lodged with the Bid cum Application Form. Failing this, the Company and the Selling Shareholders in consultation with BRLMs reserve the

right to reject any Bid without assigning any reason thereof. Bids made by asset management companies or custodians of Mutual Funds shall specifically state names of the concerned schemes for which such Bids are made.

In case of a Mutual Fund, a separate Bid may be made in respect of each scheme of a Mutual Fund registered with the SEBI and such Bids in respect of more than one scheme of a Mutual Fund will not be treated as multiple Bids, provided that such Bids clearly indicate the scheme for which the Bid is submitted.

No Mutual Fund scheme shall invest more than 10% of its net asset value in equity shares or equity related instruments of any single company provided that the limit of 10% shall not be applicable for investments in case of index funds or sector or industry specific scheme. No Mutual Fund under all its schemes should own more than 10% of any company's paid-up share capital carrying voting rights.

### **Bids by Eligible NRIs**

Eligible NRIs may obtain copies of Bid cum Application Form from the offices of the Designated Intermediaries. Only Bids accompanied by payment in Indian Rupees or freely convertible foreign exchange will be considered for Allotment. Eligible NRIs Bidding on a repatriation basis should authorise their SCSBs or confirm or accept the UPI Mandate Request (in case of Retail Individual Investors Bidding through the UPI Mechanism) to block their Non-Resident External Accounts (“**NRE Account**”), or Foreign Currency Non-Resident Accounts (“**FCNR Account**”), and Eligible NRIs bidding on a non-repatriation basis should authorise their SCSBs or confirm or accept the UPI Mandate Request (in case of Retail Individual Investors Bidding through the UPI Mechanism) to block their Non-Resident Ordinary (“**NRO**”) accounts for the full Bid amount, at the time of submission of the Bid cum Application Form. Participation of Eligible NRIs in the Offer shall be subject to the FEMA regulations. NRIs applying in the Offer through the UPI Mechanism are advised to enquire with the relevant bank, whether their account is UPI linked, prior to submitting a Bid cum Application Form.

Eligible NRIs Bidding on a repatriation basis are advised to use the Bid cum Application Form meant for Non-Residents ([●] in colour).

Eligible NRIs Bidding on non-repatriation basis are advised to use the Bid cum Application Form for residents ([●] in colour). By way of Press Note 1 (2021 Series) dated March 19, 2021, issued by the DPIIT, it has been clarified that an investment made by an Indian entity which is owned and controlled by NRIs on a non-repatriation basis, shall not be considered for calculation of indirect foreign investment.

For details of restrictions on investment by NRIs, see “*Restrictions on Foreign Ownership of Indian Securities*” on page 369.

### **Bids by HUFs**

Bids by Hindu Undivided Families or HUFs should be made in the individual name of the karta. The Bidder should specify that the Bid is being made in the name of the HUF in the Bid cum Application Form/Application Form as follows: “Name of sole or First Bidder: XYZ Hindu Undivided Family applying through XYZ, where XYZ is the name of the karta”. Bids by HUFs will be considered at par with Bids from individuals.

### **Bids by FPIs**

In terms of applicable FEMA Rules and the SEBI FPI Regulations, investments by FPIs in the Equity Shares is subject to certain limits, *i.e.*, the individual holding of an FPI or an investor group (which means multiple entities registered as foreign portfolio investors and directly or indirectly, having common ownership of more than 50% or common control)) shall be below 10% of our post-Offer Equity Share capital on a fully diluted basis. In case the total holding of an FPI or investor group increases beyond 10% of the total paid-up Equity Share capital of our Company, on a fully diluted basis, the total investment made by the FPI or investor group will be re-classified as FDI subject to the conditions as specified by SEBI and the RBI in this regard and our Company and the investor will be required to comply with applicable reporting requirements. Further, the total holdings of all FPIs put together, with effect from April 1, 2020, can be up to the sectoral cap applicable to the sector in which our Company operates (*i.e.*, up to 100%). In terms of the FEMA Rules, for calculating the aggregate holding of FPIs in a company, holding of all registered FPIs shall be included.

In case of Bids made by FPIs, a certified copy of the certificate of registration issued under the SEBI FPI Regulations is required to be attached to the Bid cum Application Form, failing which our Company and the Selling Shareholders in consultation with BRLMs, reserve the right to reject any Bid without assigning any reason. FPIs who wish to participate

in the Offer are advised to use the Bid cum Application Form for Non-Residents ([●] in colour).

To ensure compliance with the above requirement, SEBI, pursuant to its circular dated July 13, 2018, has directed that at the time of finalisation of the Basis of Allotment, the Registrar shall (i) use the PAN issued by the Income Tax Department of India for checking compliance for a single FPI; and (ii) obtain validation from Depositories for the FPIs who have invested in the Offer to ensure there is no breach of the investment limit, within the timelines for issue procedure, as prescribed by SEBI from time to time.

Subject to compliance with all applicable Indian laws, rules, regulations, guidelines and approvals in terms of Regulation 21 of the SEBI FPI Regulations, an FPI is permitted to issue, subscribe to, or otherwise deal in offshore derivative instruments, directly or indirectly, only if it complies with the following conditions:

- (a) such offshore derivative instruments are issued only by persons registered as Category I FPIs;
- (b) such offshore derivative instruments are issued only to persons eligible for registration as Category I FPIs;
- (c) such offshore derivative instruments are issued after compliance with the 'know your client' norms as specified by SEBI; and
- (d) such other conditions as may be specified by SEBI from time to time.

An FPI is required to ensure that the transfer of an offshore derivative instruments issued by or on behalf of it, is subject to (a) the transfer being made to persons which fulfil the criteria provided under Regulation 21(1) of the SEBI FPI Regulations (as mentioned above from points (a) to (d)); and (b) prior consent of the FPI is obtained for such transfer, except in cases, where the persons to whom the offshore derivative instruments are to be transferred, are pre-approved by the FPI.

Bids by following FPIs, submitted with the same PAN but with different beneficiary account numbers, Client IDs and DP IDs shall not be treated as multiple Bids:

- FPIs which utilise the multi-investment manager structure;
- Offshore derivative instruments which have obtained separate FPI registration for ODI and proprietary derivative investments;
- Sub funds or separate class of investors with segregated portfolio who obtain separate FPI registration;
- FPI registrations granted at investment strategy level/sub fund level where a collective investment scheme or fund has multiple investment strategies/sub-funds with identifiable differences and managed by a single investment manager;
- Multiple branches in different jurisdictions of foreign bank registered as FPIs;
- Government and Government related investors registered as Category 1 FPIs; and
- Entities registered as collective investment scheme having multiple share classes.

The Bids belonging to any of the above mentioned seven structures and having same PAN may be collated and identified as a single Bid in the Bidding process. The Equity Shares allotted in the Bid may be proportionately distributed to the applicant FPIs (with same PAN).

In order to ensure valid Bids, FPIs making multiple Bids using the same PAN, and with different beneficiary account numbers, Client IDs and DP IDs, are required to provide a confirmation along with each of their Bid cum Application Forms that the relevant FPIs making multiple Bids utilize any of the above-mentioned structures and indicate the name of their respective investment managers in such confirmation. In the absence of such compliance from the relevant FPIs with the operational guidelines for FPIs and designated Depository Participants issued to facilitate implementation of SEBI FPI Regulations, such multiple Bids shall be rejected.

Participation of FPIs in the Offer shall be subject to the FEMA Rules.

The FPIs who wish to participate in the Offer are advised to use the Bid cum Application Form for non-residents.



## **Bids by SEBI registered Alternative Investment Funds, Venture Capital Funds and Foreign Venture Capital Investors**

The Securities and Exchange Board of India (Alternative Investment Funds) Regulations, 2012, as amended (the “**SEBI AIF Regulations**”) prescribe, amongst others, the investment restrictions on AIFs. Post the repeal of the Securities and Exchange Board of India (Venture Capital Funds) Regulations, 1996, venture capital funds which have not re-registered as AIFs under the SEBI AIF Regulations shall continue to be regulated by the Securities and Exchange Board of India (Venture Capital Funds) Regulations, 1996 until the existing fund or scheme managed by the fund is wound up and such fund shall not launch any new scheme after the notification of the SEBI AIF Regulations. The SEBI FVCI Regulations prescribe the investment restrictions on FVCIs.

The category I and II AIFs cannot invest more than 25% of their investible funds in one investee company. A category III AIF cannot invest more than 10% of its investible funds in one investee company. A VCF registered as a category I AIF, cannot invest more than one-third of its investible funds, in the aggregate, in certain specified instruments, including by way of subscription to an initial public offering of a venture capital undertaking. An FVCI can invest only up to 33.33% of its investible funds, in the aggregate, in certain specified instruments, which includes subscription to an initial public offering of a venture capital undertaking or an investee company (as defined under the SEBI AIF Regulations) whose shares are proposed to be listed.

Participation of AIFs, VCFs and FVCIs shall be subject to the FEMA Rules.

Further, the shareholding of VCFs, category I AIFs or category II AIFs and FVCIs holding equity shares of a company prior to an initial public offering being undertaken by such company, shall be exempt from lock-in requirements, provided that such equity shares shall be locked in for a period of at least six months from the date of purchase by the venture capital fund or alternative investment fund or foreign venture capital investor.

There is no reservation for Eligible NRI Bidders, AIFs, FPIs and FVCIs. All Bidders will be treated on the same basis with other categories for the purpose of allocation.

**All non-resident investors should note that refunds (in case of Anchor Investors), dividends and other distributions, if any, will be payable in Indian Rupees only and net of bank charges and commission.**

Our Company, the Selling Shareholders or the BRLMs will not be responsible for loss, if any, incurred by the Bidder on account of conversion of foreign currency.

### **Bids by limited liability partnerships**

In case of Bids made by limited liability partnerships registered under the Limited Liability Partnership Act, 2008, a certified copy of certificate of registration issued under the Limited Liability Partnership Act, 2008, must be attached to the Bid cum Application Form. Failing this, our Company and the Selling Shareholders in consultation with BRLMs, reserve the right to reject any Bid without assigning any reason thereof.

### **Bids by banking companies**

In case of Bids made by banking companies registered with RBI, certified copies of: (i) the certificate of registration issued by RBI, and (ii) the approval of such banking company’s investment committee is required to be attached to the Bid cum Application Form, failing which our Company and the Selling Shareholders in consultation with BRLMs, reserve the right to reject any Bid without assigning any reason thereof, subject to applicable law.

The investment limit for banking companies in non-financial services companies as per the Banking Regulation Act, 1949 (the “**Banking Regulation Act**”), and Master Direction – Reserve Bank of India (Financial Services provided by Banks) Directions, 2016 is 10% of the paid-up share capital of the investee company or 10% of the bank’s own paid-up share capital and reserves, as per the last audited balance sheet or a subsequent balance sheet, whichever is less. Further, the aggregate investment in subsidiaries and other entities engaged in financial and non-financial services company cannot exceed 20% of the bank’s paid-up share capital and reserves. A banking company would be permitted to invest in excess of 10% but not exceeding 30% of the paid-up share capital of such investee company if: (a) the investee company is engaged in non-financial activities in which banking companies are permitted to engage under the Banking Regulation Act or the additional acquisition is through restructuring of debt/corporate debt restructuring/strategic debt restructuring, or to protect the bank’s interest on loans/investments made to a company, provided that the bank is required to submit a

time-bound action plan for disposal of such shares (in this sub-clause (b)) within a specified period to the RBI. A banking company would require a prior approval of the RBI to make investment in excess of 30% of the paid-up share capital of the investee company, investment in a subsidiary and a financial services company that is not a subsidiary (with certain exceptions prescribed), and investment in a non-financial services company in excess of 10% of such investee company's paid-up share capital as stated in the Reserve Bank of India (Financial Services provided by Banks) Directions, 2016, as amended.

### **Bids by SCSBs**

SCSBs participating in the Offer are required to comply with the terms of the circulars dated September 13, 2012 and January 2, 2013 issued by SEBI. Such SCSBs are required to ensure that for making applications on their own account using ASBA, they should have a separate account in their own name with any other SEBI registered SCSBs. Further, such account shall be used solely for the purpose of making application in public issues and clear demarcated funds should be available in such account for such Bids.

### **Bids by insurance companies**

In case of Bids made by insurance companies registered with the IRDAI, a certified copy of certificate of registration issued by IRDAI must be attached to the Bid cum Application Form. Failing this, the Company and the Selling Shareholders in consultation with BRLMs, reserve the right to reject any Bid without assigning any reason thereof. The exposure norms for insurers are prescribed under Regulation 9 of the Insurance Regulatory and Development Authority of India (Investment) Regulations, 2016 (“**IRDAI Investment Regulations**”), and are based on investments in the equity shares of a company, the entire group of the investee company and the industry sector in which the investee company operates. Bidders are advised to refer to the IRDAI Investment Regulations for specific investment limits applicable to them and shall comply with all applicable regulations, guidelines and circulars issued by IRDAI from time to time.

### **Bids by Systemically Important Non-Banking Financial Companies**

In case of Bids made by NBFC-SI, a certified copy of the certificate of registration issued by the RBI, a certified copy of its last audited financial statements on a standalone basis and a net worth certificate from its statutory auditor(s), must be attached to the Bid-cum Application Form. Failing this, our Company and the Selling Shareholders, in consultation with BRLMs, reserve the right to reject any Bid, without assigning any reason thereof. NBFC-SI participating in the Offer shall comply with all applicable regulations, guidelines and circulars issued by RBI from time to time.

### **Bids under Power of Attorney**

In case of Bids made pursuant to a power of attorney by limited companies, corporate bodies, registered societies, eligible FPIs, AIFs, Mutual Funds, insurance companies, NBFC-SI, insurance funds set up by the army, navy or air force of the India, insurance funds set up by the Department of Posts, India or the National Investment Fund and provident funds with a minimum corpus of ₹250 million (subject to applicable laws) and pension funds with a minimum corpus of ₹250 million, a certified copy of the power of attorney or the relevant resolution or authority, as the case may be, along with a certified copy of the memorandum of association and articles of association and/or bye laws must be lodged along with the Bid cum Application Form. Failing this, our Company and the Selling Shareholders, in consultation with the BRLMs reserve the right to accept or reject any Bid in whole or in part, in either case, without assigning any reason thereof.

Our Company and Selling Shareholders in consultation with the BRLMs, in their absolute discretion, reserve the right to relax the above condition of simultaneous lodging of the power of attorney along with the Bid cum Application Form, subject to such terms and conditions that our Company and Selling Shareholders in consultation with the BRLMs, may deem fit.

### **Bids by provident funds/pension funds**

In case of Bids made by provident funds/pension funds, subject to applicable laws, with minimum corpus of ₹250 million, a certified copy of certificate from a chartered accountant certifying the corpus of the provident fund/ pension fund must be attached to the Bid cum Application Form. Failing this, our Company and the Selling Shareholders, in consultation with BRLMs reserve the right to reject any Bid, without assigning any reason therefor.

**The above information is given for the benefit of the Bidders. Our Company, the Selling Shareholders and the Book Running Lead Managers are not liable for any amendments or modifications or changes in applicable laws or regulations, which may occur after the date of the Red Herring Prospectus, when filed. Bidders are advised to**

**make their independent investigations and ensure that any single Bid from them does not exceed the applicable investment limits or maximum number of the Equity Shares that can be held by them under applicable laws or regulation and as specified in this Draft Red Herring Prospectus, or as will be specified in the Red Herring Prospectus and the Prospectus, when filed.**

**In accordance with RBI regulations, OCBs cannot participate in the Offer.**

### **Information for Bidders**

The relevant Designated Intermediary will enter a maximum of three Bids at different price levels opted in the Bid cum Application Form and such options are not considered as multiple Bids. It is the Bidder's responsibility to obtain the acknowledgment slip from the relevant Designated Intermediary. The registration of the Bid by the Designated Intermediary does not guarantee that the Equity Shares shall be allocated/Allotted. Such Acknowledgement Slip will be non-negotiable and by itself will not create any obligation of any kind. When a Bidder revises his or her Bid, he /she shall surrender the earlier Acknowledgement Slip and may request for a revised acknowledgment slip from the relevant Designated Intermediary as proof of his or her having revised the previous Bid.

In relation to electronic registration of Bids, the permission given by the Stock Exchanges to use their network and software of the electronic bidding system should not in any way be deemed or construed to mean that the compliance with various statutory and other requirements by our Company and/or the BRLMs are cleared or approved by the Stock Exchanges; nor does it in any manner warrant, certify or endorse the correctness or completeness of compliance with the statutory and other requirements, nor does it take any responsibility for the financial or other soundness of our Company, the management or any scheme or project of our Company; nor does it in any manner warrant, certify or endorse the correctness or completeness of any of the contents of this Draft Red Herring Prospectus or the Red Herring Prospectus; nor does it warrant that the Equity Shares will be listed or will continue to be listed on the Stock Exchanges.

### **Pre-Offer Advertisement**

Subject to Section 30 of the Companies Act, our Company will, after filing the Red Herring Prospectus with the RoC, publish a pre-Offer advertisement, in the form prescribed by the SEBI ICDR Regulations, in [●] editions of [●], an English national daily newspaper, [●] editions of [●], a Hindi national daily newspaper, and [●] editions of [●], a Gujarati daily newspaper (Gujarati being the regional language of Gujarat, where our Registered Office is located). Our Company shall, in the pre-Offer advertisement state the Bid/Offer Opening Date, the Bid/Offer Closing Date and the QIB Bid/Offer Closing Date. This advertisement, subject to the provisions of Section 30 of the Companies Act, shall be in the format prescribed in Part A of Schedule X of the SEBI ICDR Regulations.

### **Signing of Underwriting Agreement and filing of Prospectus with the RoC**

Our Company and the Selling Shareholders intend to enter into an Underwriting Agreement with the Underwriters on or after the determination of the Offer Price. After signing the Underwriting Agreement, the Company will file the Prospectus with the RoC. The Prospectus would have details of the Offer Price, Anchor Investor Offer Price, Offer Size and underwriting arrangements and would be complete in all material respects.

### **General Instructions**

Please note that QIBs and Non-Institutional Investors are not permitted to withdraw their Bid(s) or lower the size of their Bid(s) (in terms of quantity of Equity Shares or the Bid Amount) at any stage. Retail Individual Investors and Eligible Employees Bidding in the Employee Reservation Portion can revise or withdraw their Bid(s) until the Bid/ Offer Closing Date. Anchor Investors are not allowed to withdraw or lower the size of their Bids after the Anchor Investor Bidding Date.

### **Do's:**

1. Check if you are eligible to apply as per the terms of the Red Herring Prospectus and under applicable law, rules, regulations, guidelines and approvals. All Bidders (other than Anchor Investors) should submit their Bids through the ASBA process only;
2. Ensure that you have Bid within the Price Band;
3. Ensure that you have mentioned the correct ASBA Account number (for all Bidders other than Retail Individual

Investors Bidding using the UPI Mechanism) in the Bid cum Application Form and such ASBA account belongs to you and no one else. Retail Individual Investors using the UPI Mechanism must mention their correct UPI ID and shall use only his/her own bank account which is linked to such UPI ID;

4. Retail Individual Investors Bidding using the UPI Mechanism shall ensure that the bank, with which they have their bank account, where the funds equivalent to the application amount are available for blocking is UPI 2.0 certified by NPCI before submitting the ASBA Form to any of the Designated Intermediaries;
5. Retail Individual Investors Bidding using the UPI Mechanism shall make Bids only through the SCSBs, mobile applications and UPI handles whose name appears in the list of SCSBs which are live on UPI, as displayed on the SEBI website. An application made using incorrect UPI handle or using a bank account of an SCSB or bank which is not mentioned on the SEBI website is liable to be rejected;
6. Read all the instructions carefully and complete the Bid cum Application Form in the prescribed form;
7. Ensure that the details about the PAN, DP ID, Client ID and UPI ID (where applicable) are correct and the Bidders depository account is active, as Allotment of the Equity Shares will be in dematerialized form only;
8. Ensure that your Bid cum Application Form bearing the stamp of a Designated Intermediary is submitted to the Designated Intermediary at the Bidding Centre within the prescribed time. RIIs using UPI Mechanism, may submit their ASBA Forms with Syndicate, sub-Syndicate Members, Registered Brokers, RTA or CDP;
9. In case of joint Bids, ensure that First Bidder is the ASBA Account holder (or the UPI-linked bank account holder, as the case may be) and the signature of the First Bidder is included in the Bid cum Application Form;
10. All Bidders (other than Anchor Investors) should submit their Bids through the ASBA process only;
11. Ensure that the name(s) given in the Bid cum Application Form is/are exactly the same as the name(s) in which the beneficiary account is held with the Depository Participant. In case of joint Bids, the Bid cum Application Form should contain only the name of the First Bidder whose name should also appear as the first holder of the beneficiary account held in joint names;
12. Bidders should ensure that they receive the Acknowledgment slip or the acknowledgement number duly signed and stamped by a Designated Intermediary, as applicable, for submission of the Bid cum Application Form;
13. Ensure that you have funds equal to the Bid Amount in the ASBA Account maintained with the SCSB before submitting the Bid cum Application Form under the ASBA process to any of the Designated Intermediaries;
14. Ensure that you submit revised Bids to the same Designated Intermediary, through whom the original Bid was placed and obtain a revised acknowledgment;
15. Except for Bids (i) on behalf of the Central or State Governments and the officials appointed by the courts, who, in terms of a SEBI circular dated June 30, 2008, may be exempt from specifying their PAN for transacting in the securities market, (ii) Bids by persons resident in the state of Sikkim, who, in terms of a SEBI circular dated July 20, 2006, may be exempted from specifying their PAN for transacting in the securities market, and (iii) any other category of Bidders, including without limitation, multilateral/ bilateral institutions, which may be exempted from specifying their PAN for transacting in the securities market, all Bidders should mention their PAN allotted under the IT Act. The exemption for the Central or the State Government and officials appointed by the courts and for investors residing in the State of Sikkim is subject to (a) the Demographic Details received from the respective depositories confirming the exemption granted to the beneficiary owner by a suitable description in the PAN field and the beneficiary account remaining in "active status"; and (b) in the case of residents of Sikkim, the address as per the Demographic Details evidencing the same. All other applications in which PAN is not mentioned will be rejected;
16. Ensure that the Demographic Details are updated, true and correct in all respects;
17. Ensure that thumb impressions and signatures other than in the languages specified in the Eighth Schedule to the Constitution of India are attested by a Magistrate or a Notary Public or a Special Executive Magistrate under official seal;
18. Ensure that the category and the investor status is indicated in the Bid cum Application Form to ensure proper upload of your Bid in the electronic Bidding system of the Stock Exchanges;

19. Ensure that in case of Bids under power of attorney or by limited companies, corporates, trust etc., relevant documents are submitted;
20. Ensure that Bids submitted by any person outside India should be in compliance with applicable foreign and Indian laws;
21. Retail Individual Investors Bidding using the UPI Mechanism, should ensure that they approve the UPI Mandate Request generated by the Sponsor Bank to authorise blocking of funds equivalent to application amount and subsequent debit of funds in case of Allotment, in a timely manner;
22. Note that in case the DP ID, UPI ID (where applicable), Client ID and the PAN mentioned in their Bid cum Application Form and entered into the online IPO system of the Stock Exchanges by the relevant Designated Intermediary, as the case may be, do not match with the DP ID, UPI ID (where applicable), Client ID and PAN available in the Depository database, then such Bids are liable to be rejected;
23. However, Bids received from FPIs bearing the same PAN shall not be treated as multiple Bids in the event such FPIs utilise the MIM Structure and such Bids have been made with different beneficiary account numbers, Client IDs and DP IDs.
24. FPIs making MIM Bids using the same PAN, and different beneficiary account numbers, Client IDs and DP IDs, are required to submit a confirmation that their Bids are under the MIM structure and indicate the name of their investment managers in such confirmation which shall be submitted along with each of their Bid cum Application Forms. In the absence of such confirmation from the relevant FPIs, such MIM Bids shall be rejected;
25. In case of QIBs and NIIs, ensure that while Bidding through a Designated Intermediary, the ASBA Form is submitted to a Designated Intermediary in a Bidding Centre and that the SCSB where the ASBA Account, as specified in the ASBA Form, is maintained has named at least one branch at that location for the Designated Intermediary to deposit ASBA Forms (a list of such branches is available on the website of SEBI at <http://www.sebi.gov.in>);
26. Ensure that you have correctly signed the authorization /undertaking box in the Bid cum Application Form, or have otherwise provided an authorization to the SCSB or the Sponsor Bank, as applicable via the electronic mode, for blocking funds in the ASBA Account equivalent to the Bid Amount mentioned in the Bid cum Application Form at the time of submission of the Bid;
27. Retail Individual Investors Bidding using the UPI Mechanism shall ensure that details of the Bid are reviewed and verified by opening the attachment in the UPI Mandate Request and then proceed to authorise the UPI Mandate Request using his/her UPI PIN. Upon the authorization of the mandate using his/her UPI PIN, the Retail Individual Investor shall be deemed to have verified the attachment containing the application details of the Retail Individual Investor Bidding using the UPI Mechanism in the UPI Mandate Request and have agreed to block the entire Bid Amount and authorized the Sponsor Bank to issue a request to block the Bid Amount mentioned in the Bid Cum Application Form in his/her ASBA Account;
28. Retail Individual Investors Bidding using the UPI Mechanism should mention valid UPI ID of only the Bidder (in case of single account) and of the First Bidder (in case of joint account) in the Bid cum Application Form;
29. Retail Individual Investors Bidding using the UPI Mechanism, who have revised their Bids subsequent to making the initial Bid, should also approve the revised UPI Mandate Request generated by the Sponsor Bank to authorise blocking of funds equivalent to the revised Bid Amount in his/her account and subsequent debit of funds in case of allotment in a timely manner;
30. Bids by Eligible NRIs, HUFs and any individuals, corporate bodies and family offices, which are re-categorised as category II FPI and registered with SEBI, for a Bid Amount of less than ₹200,000 would be considered under the Retail Portion for the purposes of allocation and Bids for a Bid Amount exceeding ₹200,000 would be considered under the Non-Institutional Category for allocation in the Offer;
31. Ensure that Anchor Investors submit their Bid cum Application Forms only to the BRLMs; and
32. Ensure that you have accepted the UPI Mandate Request received from the Sponsor Bank prior to 12:00 p.m. of the Working Day immediately after the Bid/ Offer Closing Date.

The Bid cum Application Form is liable to be rejected if the above instructions, as applicable, are not complied with. Application made using incorrect UPI handle or using a bank account of an SCSB or SCSBs which is not mentioned in the Annexure 'A' to the SEBI circular no. SEBI/HO/CFD/DIL2/CIR/P/2019/85 dated July 26, 2019 is liable to be rejected.

***Don'ts:***

1. Do not Bid for lower than the minimum Bid size;
2. Do not Bid/revise Bid Amount to less than the Floor Price or higher than the Cap Price;
3. Do not Bid on another Bid cum Application Form after you have submitted a Bid to a Designated Intermediary;
4. Do not pay the Bid Amount in cash, by money order, cheques or demand drafts or by postal order or by stock invest;
5. Do not send Bid cum Application Forms by post, instead submit the same to the Designated Intermediary only;
6. Anchor Investors should not Bid through the ASBA process;
7. Anchor Investors should submit Anchor Investor Application Form only to the BRLMs;
8. Do not submit the ASBA Forms to any non-SCSB bank or to our Company or at a location other than the Bidding Centres;
9. Do not submit the ASBA Forms to any Designated Intermediary that is not authorised to collect the relevant ASBA Forms;
10. Do not Bid on a physical Bid cum Application Form that does not have the stamp of the relevant Designated Intermediary;
11. Do not Bid at Cut-off Price (for Bids by QIBs and Non-Institutional Investors);
12. Do not fill up the Bid cum Application Form such that the Equity Shares Bid for exceeds the Offer/Offer size and/or investment limit or maximum number of the Equity Shares that can be held under the applicable laws or regulations or maximum amount permissible under the applicable regulations or under the terms of the Red Herring Prospectus;
13. Do not submit your Bid after 3.00 pm on the Bid/Offer Closing Date;
14. If you are a QIB, do not submit your Bid after 3.00 p.m. on the QIB Bid/Offer Closing Date;
15. Do not instruct your respective banks to release the funds blocked in the ASBA Account under the ASBA process;
16. If you are a RII and are using UPI mechanism, do not submit more than one Bid cum Application Form for each UPI ID;
17. Do not submit the General Index Register (GIR) number instead of the PAN;
18. Do not submit incorrect details of the DP ID, Client ID, PAN and UPI ID (where applicable) or provide details for a beneficiary account which is suspended or for which details cannot be verified by the Registrar to the Offer;
19. Do not submit the Bid without ensuring that funds equivalent to the entire Bid Amount are available for blocking in the relevant ASBA Account or in the case of Retail Individual Investors Bidding using the UPI Mechanism, in the UPI-linked bank account where funds for making the Bid are available;
20. Do not withdraw your Bid or lower the size of your Bid (in terms of quantity of the Equity Shares or the Bid Amount) at any stage, if you are a QIB or a Non-Institutional Investor. Retail Individual Investors and Eligible Employees Bidding in the Employee Reservation Portion can revise or withdraw their Bids until the Bid/Offer Closing Date;
21. Do not submit Bids on plain paper or on incomplete or illegible Bid cum Application Forms or on Bid cum

Application Forms in a colour prescribed for another category of Bidder;

22. Do not link the UPI ID with a bank account maintained with a bank that is not UPI 2.0 certified by the NPCI in case of Bids submitted by Retail Individual Investors using the UPI Mechanism;
23. Do not submit a Bid in case you are not eligible to acquire Equity Shares under applicable law or your relevant constitutional documents or otherwise;
24. Do not Bid if you are not competent to contract under the Indian Contract Act, 1872 (other than minors having valid depository accounts as per Demographic Details provided by the depository);
25. Do not submit more than one Bid cum Application Form per ASBA Account. If you are a Retail Individual Investor Bidding using the UPI Mechanism, do not submit Bids through an SCSB and/or mobile application and/or UPI handle that is not listed on the website of SEBI;
26. Do not submit a Bid using UPI ID, if you are not a Retail Individual Investor;
27. Do not Bid for Equity Shares more than specified by respective Stock Exchanges for each category;
28. Do not submit a Bid cum Application Form with third party UPI ID or using a third party bank account (in case of Bids submitted by Retail Individual Investors using the UPI Mechanism); and
29. Do not Bid if you are an OCB.

For helpline details of the Book Running Lead Managers pursuant to the SEBI circular bearing reference number SEBI/HO.CFD.DIL2/CIR/P/2021/2480/1/M dated March 16, 2021, see “*General Information – Book Running Lead Managers*” on page 69.

**The Bid cum Application Form is liable to be rejected if the above instructions, as applicable, are not complied with.**

In case of any pre-Offer or post Offer related issues regarding demat credit/refund orders/unblocking etc., investors shall reach out to the Company Secretary and Compliance Officer, and the Registrar. For details of the Company Secretary and Compliance Officer and the Registrar, see “*General Information*” on page 68.

### **Grounds for Technical Rejection**

In addition to the grounds for rejection of Bids on technical grounds as provided in the GID, Bidders are requested to note that Bids maybe rejected on the following additional technical grounds:

1. Bids submitted without instruction to the SCSBs to block the entire Bid Amount;
2. Bids which do not contain details of the Bid Amount and the bank account details in the ASBA Form;
3. Bids submitted on a plain paper;
4. Bids submitted by RIIs using the UPI Mechanism through an SCSBs and/or using a mobile application or UPI handle, not listed on the website of SEBI;
5. Bids under the UPI Mechanism submitted by RIIs using third party bank accounts or using a third party linked bank account UPI ID (subject to availability of information regarding third party account from Sponsor Bank);
6. ASBA Form by the RIIs using third party bank accounts or using third party linked bank account UPI IDs;
7. ASBA Form submitted to a Designated Intermediary does not bear the stamp of the Designated Intermediary;
8. Bids submitted without the signature of the First Bidder or sole Bidder;
9. The ASBA Form not being signed by the account holders, if the account holder is different from the Bidder;
10. Bids by persons for whom PAN details have not been verified and whose beneficiary accounts are “suspended for

credit” in terms of SEBI circular CIR/MRD/DP/ 22 /2010 dated July 29, 2010;

11. GIR number furnished instead of PAN;
12. Bids by RIIs with Bid Amount of a value of more than ₹200,000;
13. Bids by persons who are not eligible to acquire Equity Shares in terms of all applicable laws, rules, regulations, guidelines and approvals;
14. Bids accompanied by stock invest, money order, postal order or cash; and
15. Bids uploaded by QIBs after 4.00 pm on the QIB Bid/ Offer Closing Date and by Non-Institutional Investors uploaded after 4.00 p.m. on the Bid/ Offer Closing Date, and Bids by RIIs uploaded after 5.00 p.m. on the Bid/ Offer Closing Date, unless extended by the Stock Exchanges.

Further, in case of any pre-issue or post issue related issues regarding share certificates/demat credit/refund orders/unblocking etc., investors shall reach out the Company Secretary and Compliance Officer. For details of the Company Secretary and Compliance Officer, see “*General Information*” on page 68.

In case of any delay in unblocking of amounts in the ASBA Accounts (including amounts blocked through the UPI Mechanism) exceeding four Working Days from the Bid/ Offer Closing Date, the Bidder shall be compensated in accordance with applicable law. Further, Investors shall be entitled to compensation in the manner specified in the SEBI circular no. SEBI/HO/CFD/DIL2/CIR/P/2021/2480/1/M dated March 16, 2021 in case of delays in resolving investor grievances in relation to blocking/unblocking of funds.

The processing fees for applications made by Retail Individual Investors using the UPI Mechanism may be released to the remitter banks (SCSBs) only after such banks provide a written confirmation on compliance with SEBI Circular No: SEBI/HO/CFD/DIL2/P/CIR/P/2021/750 dated June 2, 2021 read with SEBI Circular No: SEBI/HO/CFD/DIL2/P/CIR/P/2021/2480/1/M dated March 16, 2021.

#### **Names of entities responsible for finalising the basis of allotment in a fair and proper manner**

The authorised employees of the Designated Stock Exchange, along with the BRLMs and the Registrar, shall ensure that the basis of allotment is finalised in a fair and proper manner in accordance with the procedure specified in SEBI ICDR Regulations.

#### **Method of allotment as may be prescribed by SEBI from time to time**

Our Company will not make any Allotment in excess of the Equity Shares offered through the Offer except in case of oversubscription for the purpose of rounding off to make Allotment, in consultation with the Designated Stock Exchange. Further, upon oversubscription, an Allotment of not more than 1% of the net offer to public may be made for the purpose of making Allotment in minimum lots.

The allotment of Equity Shares to Bidders other than to the Retail Individual Investors and Anchor Investors shall be on a proportionate basis within the respective investor categories and the number of securities allotted shall be rounded off to the nearest integer, subject to minimum allotment being equal to the minimum application size as determined and disclosed.

The allotment of Equity Shares to each Retail Individual Investor shall not be less than the minimum bid lot, subject to the availability of shares in Retail Individual Investor category, and the remaining available shares, if any, shall be allotted on a proportionate basis.

#### **Payment into Escrow Account(s) for Anchor Investors**

Our Company and the Selling Shareholders, in consultation with the BRLMs, in their absolute discretion, will decide the list of Anchor Investors to whom the Allotment Advice will be sent, pursuant to which the details of the Equity Shares allocated to them in their respective names will be notified to such Anchor Investors. Anchor Investors are not permitted to Bid in the Offer through the ASBA process. Instead, Anchor Investors should transfer the Bid Amount (through direct credit, RTGS, NACH or NEFT) to the Escrow Accounts. The payment instruments for payment into the Escrow Accounts should be drawn in favour of:



- (i) In case of resident Anchor Investors: “[●]”
- (ii) In case of non-resident Anchor Investors: “[●]”

Anchor Investors should note that the escrow mechanism is not prescribed by SEBI and has been established as an arrangement between our Company, the Selling Shareholders, the Syndicate, the Bankers to the Offer and the Registrar to the Offer to facilitate collections from Anchor Investors.

### **Depository Arrangements**

The Allotment of the Equity Shares in the Offer shall be only in a dematerialised form, (*i.e.*, not in the form of physical certificates but be fungible and be represented by the statement issued through the electronic mode). In this context, tripartite agreements had been signed among our Company, the respective Depositories and the Registrar to the Offer:

- Tripartite Agreement dated December 31, 2021, among NSDL, our Company and the Registrar to the Offer.
- Tripartite Agreement dated December 16, 2021, among CDSL, our Company and Registrar to the Offer.

### **Undertakings by our Company**

Our Company undertakes the following:

- (i) that the complaints received in respect of the Offer shall be attended to by our Company expeditiously and satisfactorily;
- (ii) that if the Allotment is not made within the prescribed time period under applicable law, the entire subscription amount received will be refunded/unblocked within the time prescribed under applicable law, failing which interest will be due to be paid to the Bidders at the rate prescribed under applicable law for the delayed period;
- (iii) that all steps will be taken for completion of the necessary formalities for listing and commencement of trading at all the Stock Exchanges where the Equity Shares are proposed to be listed within six Working Days of the Bid/Offer Closing Date or such other time as may be prescribed;
- (iv) that funds required for making refunds to unsuccessful applicants as per the mode(s) disclosed shall be made available to the Registrar to the Offer by our Company;
- (v) where refunds (to the extent applicable) are made through electronic transfer of funds, a suitable communication shall be sent to the applicant within the time prescribed under applicable law, giving details of the bank where refunds shall be credited along with amount and expected date of electronic credit of refund;
- (vi) that if our Company (in consultation with the BRLMs) does not proceed with the Offer after the Bid/Offer Closing Date but prior to Allotment, the reason thereof shall be given as a public notice within two days of the Bid/Offer Closing Date. The public notice shall be issued in the same newspapers where the pre-Offer advertisements were published. The Stock Exchanges on which the Equity Shares are proposed to be listed shall also be informed promptly;
- (vii) that if our Company and the Selling Shareholders, in consultation with the BRLMs, withdraw the Offer after the Bid/Offer Closing Date, our Company shall be required to file a fresh draft offer document with SEBI, in the event our Company and/or any of the Selling Shareholders subsequently decides to proceed with the Offer thereafter;
- (viii) that adequate arrangements shall be made to collect all Bid cum Application Forms submitted by Bidders and Anchor Investor Application Form from Anchor Investors; and
- (ix) that, except for the Pre-IPO Placement, no further issue of Equity Shares shall be made until the Equity Shares issued or offered through the Red Herring Prospectus are listed or until the Bid monies are refunded/unblocked in the ASBA Accounts on account of non-listing, under-subscription etc.

## **Undertakings by the Selling Shareholders**

Each Selling Shareholder undertakes the following in respect of itself and its respective portion of the Offered Shares:

- (i) that its portion of the Offered Shares are eligible for being offered in the Offer for Sale in terms of Regulation 8 of the SEBI ICDR Regulations and are in dematerialised form;
- (ii) that it is the legal and beneficial owner of, and has clear and marketable title to, its portion of the Offered Shares;
- (iii) it shall not offer, lend, pledge, transfer or otherwise encumber, sell, dispose of any of its portion of the Offered Shares being offered pursuant to the Offer until such time that the lock-in (if applicable) remains effective save and except as may be permitted under the SEBI ICDR Regulations.
- (iv) that it shall provide all reasonable co-operation as requested by our Company to the extent of the Offered Shares of each Selling Shareholder in relation to the completion of Allotment and dispatch of the Allotment Advice and CAN, if required, and completion of the necessary formalities for listing and commencement of trading of its portion of the Offered Shares on the Stock Exchanges and refund orders to the extent of its portion of the Offered Shares;
- (v) that it shall not have recourse to the proceeds of the Offer for Sale of its portion of the Offered Shares which shall be held in escrow in its favour, until final listing and trading approvals have been received from the Stock Exchanges; and
- (vi) that it will provide such reasonable support and extend such reasonable cooperation as may be required by our Company and the BRLMs in redressal of such investor grievances that pertain to its portion of the Offered Shares.

## **Utilisation of Offer Proceeds**

Our Board certifies that:

- all monies received out of the Fresh Issue shall be credited/transferred to a separate bank account other than the bank account referred to in sub-section (3) of Section 40 of the Companies Act, 2013;
- details of all monies utilized out of the Fresh Issue shall be disclosed, and continue to be disclosed till the time any part of the Offer proceeds remains unutilized, under an appropriate head in the balance sheet of our Company indicating the purpose for which such monies have been utilized; and
- details of all unutilized monies out of the Fresh Issue, if any shall be disclosed under an appropriate separate head in the balance sheet indicating the form in which such unutilized monies have been invested.

The Selling Shareholders, severally and not jointly, and together with our Company declare that all monies received out of the Offer shall be credited/transferred to a separate bank account other than the bank account referred to in sub-section (3) of Section 40 of the Companies Act.

## **Impersonation**

Attention of the Bidders is specifically drawn to the provisions of sub-section (1) of Section 38 of the Companies Act, 2013 which is reproduced below: “*Any person who – (a) makes or abets making of an application in a fictitious name to a company for acquiring, or subscribing for, its securities; or (b) makes or abets making of multiple applications to a company in different names or in different combinations of his name or surname for acquiring or subscribing for its securities; or (c) otherwise induces directly or indirectly a company to allot, or register any transfer of, securities to him, or to any other person in a fictitious name, shall be liable for action under Section 447.*” The liability prescribed under Section 447 of the Companies Act, 2013 for fraud involving an amount of at least ₹1 million or one per cent of the turnover of the company, whichever is lower, includes imprisonment for a term which shall not be less than six months extending up to 10 years and fine of an amount not less than the amount involved in the fraud, extending up to three times such amount (provided that where the fraud involves public interest, such term shall not be less than three years). Further, where the fraud involves an amount less than ₹1 million or one per cent of the turnover of the company, whichever is lower, and does not involve public interest, any person guilty of such fraud shall be punishable with imprisonment for a term which may extend to five years or with fine which may extend to ₹5 million or with both.

## RESTRICTIONS ON FOREIGN OWNERSHIP OF INDIAN SECURITIES

Foreign investment in Indian securities is regulated through the Industrial Policy, 1991 of the Government of India and FEMA. While the Industrial Policy, 1991 prescribes the limits and the conditions subject to which foreign investment can be made in different sectors of the Indian economy, FEMA regulates the precise manner in which such investment may be made. Under the Industrial Policy, unless specifically restricted, foreign investment is freely permitted in all sectors of the Indian economy up to any extent and without any prior approvals, but the foreign investor is required to follow certain prescribed procedures for making such investment. The RBI and the concerned ministries/departments are responsible for granting approval for foreign investment. The Government has from time to time made policy pronouncements on foreign direct investment (“FDI”) through press notes and press releases. The Department for Promotion of Industry and Internal Trade, Ministry of Commerce and Industry (formerly Department of Industrial Policy and Promotion), Government of India (“DPIIT”), issued, issued the Consolidated FDI Policy Circular of 2020 (“**FDI Policy**”), which, with effect from October 15, 2020, subsumes and supersedes all press notes, press releases, clarifications, circulars issued by the DPIIT, which were in force as on October 15, 2020. The FDI Policy will be valid until the DPIIT issues an updated circular.

The transfer of shares between an Indian resident and a non-resident does not require the prior approval of the RBI, provided that: (i) the activities of the investee company are under the automatic route under the foreign direct investment policy and transfer does not attract the provisions of the SEBI Takeover Regulations; (ii) the non-resident shareholding is within the sectoral limits under the FDI policy; and (iii) the pricing is in accordance with the guidelines prescribed by the SEBI/RBI.

On October 17, 2019, Ministry of Finance, Department of Economic Affairs, had notified the FEMA Rules, which had replaced the Foreign Exchange Management (Transfer and Issue of Security by a Person Resident Outside India) Regulations 2017. Foreign investment in this Offer shall be on the basis of the FEMA Rules. Further, in accordance with Press Note No. 3 (2020 Series), dated April 17, 2020 issued by the DPIIT and the Foreign Exchange Management (Non-debt Instruments) Amendment Rules, 2020 which came into effect from April 22, 2020, any investment, subscription, purchase or sale of equity instruments by entities of a country which shares land border with India or where the beneficial owner of an investment into India is situated in or is a citizen of any such country, will require prior approval of the Government, as prescribed in the Consolidated FDI Policy and the FEMA Rules. Further, in the event of transfer of ownership of any existing or future foreign direct investment in an entity in India, directly or indirectly, resulting in the beneficial ownership falling within the aforesaid restriction/ purview, such subsequent change in the beneficial ownership will also require approval of the Government. Pursuant to the Foreign Exchange Management (Non-debt Instruments) (Fourth Amendment) Rules, 2020 issued on December 8, 2020, a multilateral bank or fund, of which India is a member, shall not be treated as an entity of a particular country nor shall any country be treated as the beneficial owner of the investments of such bank of fund in India.

As per the FDI policy, FDI in companies engaged in the retail trading sector, which is the sector in which our Company operates, is permitted up to 100% of the paid-up share capital of such company under the automatic route.

As per the existing policy of the Government of India, OCBs cannot participate in this Offer. For further details, see “*Offer Procedure*” on page 351. Each Bidder should seek independent legal advice about its ability to participate in the Offer. In the event such prior approval of the Government of India is required, and such approval has been obtained, the Bidder shall intimate our Company and the Registrar in writing about such approval along with a copy thereof within the Bid/Offer Period.

**The Equity Shares offered in the Offer have not been and will not be registered under the U.S. Securities Act or any state securities laws of the United States and, unless so registered, may not be offered or sold within the United States, except pursuant to an exemption from, or in a transaction not subject to, the registration requirements of the U.S. Securities Act and applicable state securities laws of the United States. Accordingly, the Equity Shares are only being offered and sold only outside the United States in offshore transactions in compliance with Regulation S under the U.S. Securities Act and the applicable laws of the jurisdictions where those offers and sales occur.**

**The Equity Shares have not been and will not be registered, listed or otherwise qualified in any other jurisdiction outside India and may not be offered or sold, and Bids may not be made by persons in any such jurisdiction, except in compliance with the applicable laws of such jurisdiction.**

The above information is given for the benefit of the Bidders. Our Company, the Selling Shareholders and the BRLMs are not liable for any amendments or modification or changes in applicable laws or regulations, which may occur after

the date of this Draft Red Herring Prospectus. Bidders are advised to make their independent investigations, seek independent legal advice about its ability to participate in the Offer and ensure that the number of Equity Shares Bid for do not exceed the applicable limits under laws or regulations.

## SECTION IX - MAIN PROVISIONS OF THE ARTICLES OF ASSOCIATION

Capitalised terms used in this section have the meanings that have been given to such terms in the Articles of Association of our Company. The main provisions of the Articles of Association of our Company are detailed below.

The Articles of Association of our Company comprises of two parts, Part I and Part II, which parts shall, unless the context otherwise requires, co-exist with each other. In case of inconsistency between Part I and Part II, the provisions of Part II shall prevail. However, Part II shall automatically terminate and cease to have any force and effect from the date of receipt of final approval for listing and trading of Equity Shares on the recognized stock exchanges in India subsequent to an initial public offering of the Equity Shares without any further action by the Company or by the Shareholders and Part I shall continue to be in effect.

### PART I OF THE ARTICLES OF ASSOCIATION

#### I. PRELIMINARY

##### 1. APPLICABILITY OF TABLE F

Subject as hereinafter provided and in so far as these presents do not modify or exclude them, the regulations contained in Table 'F' of Schedule I of the Companies Act, 2013, as amended from time to time, shall apply to the Company only so far as they are not inconsistent with any of the provisions contained in these Articles or modification thereof or are not expressly or by implication excluded from these Articles.

#### II. DEFINITIONS AND INTERPRETATIONS

##### 2. In these Articles:

2.1 Unless the context otherwise requires, words or expressions contained in these Articles shall bear the same meaning as in the Act or any statutory modifications thereof in force at the date at which the Articles become binding on the Company. In these Articles, all capitalized items not defined herein below shall have the meanings assigned to them in the other parts of these Articles when defined for use.

"Act" means the Companies Act, 2013, and the rules and regulations prescribed thereunder, as now enacted or as amended from time to time and shall include any statutory replacement or re-enactment thereof and the term shall be deemed to refer to the applicable section thereof which is relatable to the relevant Article in which the said term appears in these Articles and any previous company law, so far as may be applicable;

"Alternate Director" shall have the meaning ascribed to such term in Article 149;

"Articles" shall mean the articles of association of the Company as amended or altered from time to time in accordance with the Act;

"Auditors" means independent, external statutory auditors of the Company and shall include those persons appointed under the provisions of the 'Act' or any other applicable provisions for the time being in force;

"Board of Directors" or "Board" shall mean the board of directors of the Company, as constituted from time to time in accordance with applicable provisions of Law;

"Chairman" shall have the meaning ascribed to such term in Article 163;

"Company" shall mean Landmark Cars Limited, a public company limited by shares incorporated under the Companies Act, 1956;

"Director" means any director of the Company, including alternate directors, independent directors and nominee directors appointed in accordance with these Articles and the provisions of the Act, from time to time;

"Equity Share Capital" means in relation to the Company, its equity share capital within the meaning of Section 43 of the Act, as amended from time to time;

"Equity Shares" shall mean the equity shares of the Company having a face value as prescribed under the

Memorandum of Association;

“**General Meetings**” shall mean any duly convened meeting of the Shareholders of the Company and any adjournments thereof and includes an extra-ordinary general meeting held in accordance with the Act;

“**Governmental Authority**” means any governmental, regulatory or statutory authority, government department, agency, commission, board, tribunal or court or other entity authorized to make Laws, rules or regulations or pass directions, orders or awards, having or purporting to have jurisdiction or any state or other subdivision thereof or any municipality, district or other subdivision thereof having jurisdiction pursuant to applicable Laws;

“**Investor**” or “**Investors**” shall mean TPG Growth II SF Pte. Ltd. (“**TPG Growth**”);

“**Key Managerial Personnel**” in relation to the Company, means collectively, the chief executive officer/managing director/manager, the company secretary, the whole-time directors, the chief financial officer, such other officer, not more than one level below the Directors who is in whole-time employment, designated as key managerial personnel by the Board and such other officer as maybe prescribed and declared by the Company to be a key managerial personnel;

“**Law**” shall mean:

- (i) in relation to the Persons domiciled or incorporated in India, all applicable statutes, enactments, acts of legislature or Parliament, Laws, ordinances, rules, by-Laws, regulations, notifications, guidelines, policies, directions, directives and orders of any Governmental Authority, various governmental agencies, statutory and/or regulatory authorities or any stock exchange(s) in India or in any jurisdiction but applicable to such Persons domiciled or incorporated in India; and
- (ii) in relation to Persons domiciled or incorporated overseas, all applicable statutes, enactments, acts of legislature, Laws, ordinances, rules, by-Laws, regulations, notifications, guidelines, policies, directions, directives and orders of any Governmental Authority, various governmental agencies, statutory and/or regulatory authorities or any stock exchange(s) of the relevant jurisdiction of such Persons;

“**Lien**” means any mortgage, pledge, charge, assignment, hypothecation, security interest, title retention, preferential right, option (including call commitment), trust arrangement, any voting rights, right of set-off, counterclaim or banker's lien, privilege or priority of any kind having the effect of security, any designation of loss payees or beneficiaries or any similar arrangement under or with respect to any insurance policy;

“**Member**” means a member of the Company within the meaning of Clause (55) of Section 2 of the Act, as amended from time to time, and who are the duly registered holders, from time to time of the shares of the Company and includes the subscribers to the Memorandum of the Company and the beneficial owner(s) as defined in clause (a) of sub-section (1) of Section 2 of the Depositories Act, 1996;

“**Memorandum of Association**” shall mean the memorandum of association of the Company, (as from time to time amended, modified or supplemented);

“**Original Director**” shall have the meaning ascribed to such term in Article 149;

“**Person**” shall mean any natural person, limited or unlimited liability company, body corporate or corporation, limited liability partnership, partnership (whether limited or unlimited), proprietorship, voluntary association, joint venture, unincorporated organization Hindu undivided family, trust, union, association, government or any agency or political subdivision thereof or any other entity that whether acting in an individual, fiduciary or other capacity may be treated as a person under applicable Law;

“**Promoter**” shall mean Sanjay Karsandas Thakker;

“**Preference Share Capital**” means in relation to the Company, its preference share capital within the meaning of Section 43 of the Act, as amended from time to time;

“**SEBI Regulations**” means all the Regulations, Rules, circulars, notifications, orders, advisory including all forms of communication and amendments, modification or re-enactment to any thereof as applicable to the Company and issued

by the Securities and Exchange Board of India;

“**Shares**” means a share in the Share Capital of the Company and includes stock.

“**Shareholder(s)**” shall mean such Person(s) who are holding Share(s) in the Company at any given time;

“**Share Capital**” means Equity Share Capital and Preference Share Capital;

- 2.2 The terms “writing” or “written” include printing, typewriting, lithography, photography and any other mode or modes (including electronic mode) of representing or reproducing words in a legible and non-transitory form permitted under Law.
- 2.3 The headings hereto shall not affect the construction hereof.
- 2.4 Notwithstanding anything contained in these Articles, any reference to a “person” in these Articles shall, unless the context otherwise requires, be construed to include a reference to a body corporate or an association, any individual, company, partnership, joint venture, firm, trust or body of individuals (whether incorporated or not).
- 2.5 Any reference to a particular statute or provisions of the statute shall be construed to include reference to any rules, regulations or other subordinate legislation made under the statute and shall, unless the context otherwise requires, include any statutory amendment, modification or re-enactment thereof.
- 2.6 Any reference to an agreement or other document shall be construed to mean a reference to the agreement or other document, as amended or novated from time to time.
- 2.7 Words importing the singular number includes where the context admits or requires, the plural number and vice versa.
- 2.8 Save as aforesaid, any words or expressions defined in the Act or the Depositories Act or the SEBI Regulations, shall, as the case may be, if not inconsistent with the subject or context, bear the same meaning in these Articles.

### **III. PUBLIC COMPANY**

3. The Company is a public company as defined in clause (71) of Section 2 of the Act.

### **IV. SHARE CAPITAL AND VARIATION OF RIGHTS**

4. The authorized Share Capital of the Company shall be as per Clause V of the Memorandum of Association with the power to increase or reduce or re-classify such capital from time to time in accordance with the Articles and the legislative provisions for the time being in force in this regard and with the power also to divide the Shares in the capital for the time being into Equity Share Capital and Preference Share Capital and to attach thereto respectively any preferential, qualified or special rights, privileges or conditions, in accordance with the provisions of the Act and these Articles.
5. Subject to the provisions of the Act and these Articles, the Shares in the capital of the Company shall be under the control of the Directors who may issue, allot or otherwise dispose of the same or any of them to such Persons, in such proportion and on such terms and conditions and either at a premium or at par or at a discount (subject to the compliance with Section 52 and 53 and other provisions of the Act), as they may, from time to time think fit and proper and with the sanction of the Company in the General Meeting. The Company may give to any Person or Persons the option or right to call for any Shares either at par or at a premium during such time and for such consideration as the Directors think fit, and may also issue and allot Shares in the capital of the Company on payment in full or part payment of any property sold and transferred or for any services rendered to the Company in the conduct of its business and any Shares which may be so allotted may be issued as fully paid up Shares and if so issued shall be deemed to be fully paid up Shares, provided that the option or right to call of Shares shall not be given to any Person or Persons without the sanction of the Company in the General Meeting. As regards all allotments, from time to time made, the Board shall duly comply with Sections 23 and 39 of the Act, as the case may be.

A further issue of Shares may be made in any manner whatsoever as the Board may determine including by way of preferential offer or private placement, subject to and in accordance with the Act. Save as otherwise provided

herein, the Company shall be entitled to treat the registered holder of any Share as the absolute owner thereof and accordingly shall not, except as ordered by a court of competent jurisdiction, or as by Law required, be bound to recognize any equitable or other claim to or interest in such Shares on the part of any other Person whether a creditor of the registered holder or otherwise. The Company's lien shall prevail notwithstanding that it has received notice of any such claim.

6. The Company may issue the following kinds of Shares in accordance with these Articles, the Act and other applicable Laws:
  - (i) Equity Share Capital:
    - (a) with voting rights; and / or
    - (b) with differential rights as to dividend, voting or otherwise; and
  - (ii) Preference Share Capital
7. Further, the Board shall be entitled to issue, from time to time, subject to applicable Law, any other securities, including securities convertible into shares, exchangeable into shares, or carrying a warrant, with or without any attached securities, carrying such terms as to coupon, returns, repayment, servicing, as may be decided by the terms of such issue.
8. Except as otherwise provided by the conditions of issue of the Shares or by these Articles, any capital raised by creation of new Shares shall be considered as part of the existing Share Capital and shall be subject to the provisions of these Articles and the Act with reference to payment of calls and instalments, transfer, transmission, forfeiture, lien, surrender, voting rights and otherwise.
9. Subject to the provisions of the Section 55 of Act, any Preference Shares may be issued on the terms that they are, or at the option of the Company are, liable to be redeemed on such terms and in such manner as the Company before the issue of the Shares may, by special resolution determine.
10. Subject to the provisions of the Act and these Articles, the Company shall have the power to issue Preference Share Capital carrying a right of redemption out of profits which would otherwise be available for dividend or out of the proceeds of a fresh issue of Shares made for the purpose of such redemption or liable to be redeemed at the option of the Company, and the Board may, subject to the provisions of the Act, exercise such power in such manner as it may think fit. The period of redemption of such Preference Shares shall not exceed the maximum period for redemption provided under Section 55 of the Act.
11. If at any time the Share Capital is divided into different classes of Shares, the rights attached to any class (unless otherwise provided by the terms of issue of the Shares of that class) may, subject to the provisions of Section 48 of the Act, and whether or not the Company is being wound up, be varied with the consent in writing of the holders of three-fourths of the issued Shares of that class, or with the sanction of a special resolution passed at a separate meeting of the holders of the Shares of that class. To every such separate General Meeting of the holders of the Shares of that class, the provisions of these Articles relating to General Meetings shall *mutatis mutandis* apply.
12. The rights conferred upon the holders of the Shares of any class issued with preferred or other rights shall not, unless otherwise expressly provided by the terms of issue of the Shares of that class, be deemed to be varied by the creation or issue of further Shares ranking *pari passu* therewith.
13. Subject to the provisions of the Act, the Company may issue bonus Shares to its Members out of (i) its free reserves; (ii) the securities premium account; or (iii) the capital redemption reserve account, in any manner as the Board may deem fit.
14. Subject to the provisions of these Articles, the Act, other applicable Law and subject to such other approvals, permissions or sanctions as may be necessary, the Company may issue securities or shares as the case may be, on rights basis, preferential basis, or private placement basis, under a scheme of employees' stock option and Sweat Equity shares, or in any other manner as may permitted under the Companies Act, 2013 and SEBI Regulations.
15. Any debentures, debenture-stock or other securities may be issued at a discount, premium or otherwise, if



permissible under the Act, and may be issued on the condition that they shall be convertible into Shares of any denomination and with any privileges and conditions as to redemption, surrender, drawings, allotment of Shares, attending (but not voting) at General Meetings, appointment of Directors and otherwise. Debentures with the rights to conversion into or allotment of Shares shall not be issued except with the sanction of the Company in General Meeting by a special resolution and subject to the provisions of the Act.

16. Subject to the provisions of the Act, the Company shall have the power to make compromise or make arrangements with creditors and Members, consolidate, demerge, amalgamate or merge with other company or companies in accordance with the provisions of the Act and any other applicable Laws.

## **V. NOMINATION BY SECURITIES HOLDERS**

17. Every holder of Securities of the Company may, at any time, nominate, in the manner prescribed under the Companies (Share Capital and Debentures) Rules, 2014, a Person as his nominee in whom the Securities of the Company held by him shall vest in the event of his death.
18. Where the Securities of the Company are held by more than one Person jointly, the joint holders may together nominate, in the manner prescribed under the Companies (Share Capital and Debentures) Rules, 2014, a Person as their nominee in whom all the rights in the Securities of the Company shall vest in the event of death of all the joint holders.
19. Notwithstanding anything contained in any other Law for the time being in force or in any disposition, whether testamentary or otherwise, in respect of the Securities of the Company, where a nomination made in the manner prescribed under the Companies (Share Capital and Debentures) Rules, 2014, purports to confer on any Person the right to vest the Securities of the Company, the nominee shall, on the death of the holder of Securities of the Company or, as the case may be, on the death of the joint holders become entitled to all the rights in Securities of the holder or, as the case may be, of all the joint holders, in relation to such Securities of the Company to the exclusion of all other Persons, unless the nomination is varied or cancelled in the prescribed manner under the Companies (Share Capital and Debentures) Rules, 2014.
20. Where the nominee is a minor, the holder of the Securities concerned, can make the nomination to appoint in prescribed manner under the Companies (Share Capital and Debentures) Rules, 2014, any Person to become entitled to the Securities of the Company in the event of his death, during the minority.
21. The transmission of Securities of the Company by the holders of such Securities and transfer in case of nomination shall be subject to and in accordance with the provisions of the Companies (Share Capital and Debentures) Rules, 2014.

## **VI. BUY-BACK OF SHARES**

22. Notwithstanding anything contained in these Articles but subject to the provisions of Sections 67 to 70 of the Act and other applicable provisions of the Law, the Company shall have the power to buy-back its own Shares or other securities, as it may consider necessary, subject to such limits, upon such terms and conditions and subject to such approvals as required under the Act, SEBI Regulations or any other competent authority, as may be permitted by law.

## **VII. FURTHER ISSUE OF SHARES**

23. (1) Where at any time, it is proposed to increase the subscribed capital of the Company by allotment of further Shares either out of the unissued or out of the increased Share capital then such Shares shall be offered –
  - (a) to the persons who, on the date specified under applicable law, are holders of the Shares of the Company, in proportion, as near as circumstances admit, to the paid-up Share capital on those Shares by sending a letter of offer subject to the following conditions, namely:
    - i. the offer shall be made by a notice to such holders of Shares specifying the number of Shares offered and limiting a time not being less than thirty (30) days or such other timeline as may be prescribed under applicable Laws from the date of the offer within which the offer, if not accepted, will be deemed to have been declined;
    - ii. the offer aforesaid shall be deemed to include a right exercisable by the person concerned to renounce the Shares

offered to him or any of them in favour of any other person; and the notice referred to in clause (i) hereof shall contain a statement of this right. Provided that the Directors may decline, without assigning any reason to allot any Shares to any person in whose favour any Member may, renounce the Shares offered to him.

iii. after the expiry of the time specified in the notice aforesaid, or on receipt of earlier intimation from the person to whom such notice is given that he declines to accept the Shares offered, the Board of Directors may dispose of them in such manner which is not disadvantageous to Shareholders and the Company.

(b) to employees under a scheme of employees' stock option, subject to special resolution passed by the Company and subject to such conditions as prescribed in the Act and the rules thereunder; or

(c) to any persons, if authorised by a special resolution, whether or not those persons include the persons referred to in clause (a) or clause (b) either for cash or for a consideration other than cash, at such price as may be determined in compliance with the applicable provisions of the Act and Applicable Law. Where no such special resolution is passed if the votes cast in favour of the proposal contained in the resolution moved in the general meeting by the Members who being entitled to do so, vote in person or where proxies are allowed, by proxy exceed the votes, if any, cast against the proposal by the Members, so entitled and voting and the Central Government is satisfied on an application made by the Board in this behalf that the proposal is most beneficial to the Company;

(2) The notice referred to in sub-clause (i) of clause (a) of sub-article (1) shall be dispatched through registered post or speed post or through electronic mode or courier or any other mode having proof of delivery to all the existing Shareholders at least 3 (three) days before the opening of the issue or such other timeline as may be prescribed under applicable Laws. Nothing in such notice shall be deemed:

(a) To extend the time within which the offer should be accepted; or

(b) To authorize any Person to exercise the right of renunciation for a second time, on the ground that the Person in whose favour the renunciation was first made has declined to take the shares comprised in the renunciation.

(3) Nothing in this article shall apply to the increase of the subscribed capital of the Company caused by the exercise of an option attached to the debentures issued or loan raised by the Company to convert such debentures or loans into Shares in the Company or to subscribe for Shares in the Company (whether such option is conferred in these Articles or otherwise);

Provided that the terms of issue of such debentures or the terms of such loans containing such option have been approved before the issue of such debentures or the raising of loan by a special resolution passed by the Company in general meeting.

(4) Notwithstanding anything contained in sub-clause (3) above, where any debentures have been issued or loan has been obtained from any Government by the Company, and if that Government considers it necessary in the public interest so to do, it may, by order, direct that such debentures or loans or any part thereof shall be converted into shares in the Company on such terms and conditions as appear to the Government to be reasonable in the circumstances of the case even if terms of the issue of such debentures or the raising of such loans do not include a term for providing for an option for such conversion.

Provided that where the terms and conditions of such conversion are not acceptable to the Company, it may, within sixty days from the date of communication of such order or such other timeline as may be prescribed under applicable Laws, appeal to the Tribunal which shall after hearing the company and the Government pass such order as it deems fit.

(5) In determining the terms and conditions of conversion under sub-clause (4), the Government shall have due regard to the financial position of the Company, the terms of issue of debentures or loans, as the case may be, the rate of interest payable on such debentures or loans and such other matters as it may consider necessary.

(6) Where the Government has, by an order made under sub-clause (4), directed that any debenture or loan or any part thereof shall be converted into shares in the Company and where no appeal has been preferred to the Tribunal under sub-clause (4) or where such appeal has been dismissed, the Memorandum of

Association of the Company shall, where such order has the effect of increasing the authorized Share Capital of the Company, be altered and the authorized share capital of the Company shall stand increased by an amount equal to the amount of the value of shares which such debentures or loans or part thereof has been converted into.

#### **VIII. COMMISSION**

24. The Company may exercise the powers of paying commissions conferred by sub-Section (6) of Section 40 or the Act (as amended from time to time) read with the Companies (Prospectus and Allotment of Securities) Rules, 2014 or any other provision of the Act or other applicable Law, provided that the rate per cent or amount of the commission paid or agreed to be paid shall be disclosed in the manner required by that Section and rules made thereunder.
25. The rate or amount of the commission shall not exceed the rate or amount prescribed under the rules made under sub-section (6) of Section 40 of the Act.
26. The commission may be satisfied by the payment of cash or the allotment of fully or partly paid Shares or partly in the one way and partly in the other.
27. The Company may also, on any issue of Shares or Debentures, pay such brokerage as may be lawful.

#### **IX. SHARES AND SHARE CERTIFICATES**

28. The Company shall cause to be kept a register of Members in accordance with Section 88 of the Act and applicable provisions of the Depositories Act, 1996, with details of shares held in physical and dematerialised forms in any medium as may be permitted by law, including in any form of electronic medium. The Company shall be entitled to maintain in any country outside India a “foreign register” of Members or debenture holder’s resident in that country.
29. Subject to applicable Law, every Person whose name is entered as a Member in the register of members shall be entitled to receive:
  - (i) one (1) or more certificates in marketable lots for all the Shares of each class or denomination registered in his name, without payment of any charge; or
  - (ii) several certificates, if the Board so approves (upon paying such fee as the Board so determines, subject to a maximum of twenty rupees), each for one (1) or more of such Shares, and the Company shall complete and have ready for delivery such certificates, unless prohibited by any provision of law or any order of court, tribunal or other authority having jurisdiction within 2 (two) months from the date of allotment, unless the conditions of issue thereof otherwise provide, or within 1 (one) month of the receipt of application of registration of transfer, transmission, sub-division, consolidation or renewal of any of its Shares as the case may be.
30. Every certificate shall be under the seal, if any, and shall specify the number and distinctive numbers of the Shares to which it relates and the amount paid-up thereon, shall be signed by two Directors or one Director and the company secretary and shall be in such form as prescribed under sub-section (3) of Section 46 of the Act.
31. In respect of any Share or Shares held jointly by several persons, the Company shall not be bound to issue more than 1 (one) certificate, and delivery of a certificate for a Share to 1 (one) or several joint holders shall be sufficient delivery to all such holders. Subject to the provisions of the Act, any Member of the Company shall have the right to sub-divide, split or consolidate the total number of Shares held by them in any manner and to request the Company to provide certificate(s) evidencing such sub-division, split or consolidation.
32. If any share certificate be worn out, defaced, mutilated or torn or if there be no further space on the back thereof for endorsement of transfer or in case of sub-division or consolidation of Shares, then upon production and surrender thereof to the Company, a new certificate may be issued in lieu thereof, and if any certificate is lost or destroyed then upon proof thereof to the satisfaction of the Company and on execution of such indemnity as the Board deems adequate, a new certificate in lieu thereof shall be given to the party entitled to such lost or destroyed certificate. Every certificate under this Article shall be issued without payment of fees if the Board so decides, or on payment of such fees (not exceeding INR 20 (Rupees twenty)) as the Board shall prescribe.

Provided that no fee shall be charged for issue of new certificates in replacement of those which are old, defaced or worn out or where there is no further space on the back thereof for endorsement of transfer or in case of subdivision or consolidation of Shares. Notwithstanding the foregoing provisions of this Article, the Board shall comply with applicable Law including the rules or regulations or requirements of any stock exchange, or the rules made under the Securities Contracts (Regulation) Act, 1956, or any statutory modification or re-enactment thereof, for the time being in force.

33. Subject to the provisions of the Act, the provisions of the foregoing Articles relating to issue of certificates shall *mutatis mutandis* apply to issue of certificates for any other securities including debentures of the Company.
34. If any Share stands in the names of 2 (two) or more persons, the Person first named in the register of Members of the Company shall as regards voting at meetings of the Company, service of notice and all or any matters connected with the Company, except the transfer of Shares and any other matters herein otherwise provided, be deemed to be sole holder thereof but joint holders of the Shares shall be severally as well as jointly liable for the payment of all deposits, instalments and calls due in respect of such Shares and for all incidents thereof according to the Company's Articles.
35. Except as required by law, no Person shall be recognised by the company as holding any share upon any trust, and the company shall not be bound by, or be compelled in any way to recognise (even when having notice thereof) any equitable, contingent, future or partial interest in any share, or any interest in any fractional part of a share, or (except only as by these Articles or by law otherwise provided) any other rights in respect of any share except an absolute right to the entirety thereof in the registered holder.
36. In accordance with the provisions of Section 89 of the Act, a Person whose name is entered in the register of Members of the Company as the holder of the Shares but who does not hold the beneficial interest in such Shares shall file with the Company, a declaration to that effect in the form prescribed under the Act and the Company shall make necessary filings with the Registrar as may be required, within a prescribed period as set out in the Act and the rules framed thereunder.

## **X. CALLS ON SHARES**

37. Subject to the provisions of the Act, the Board may, from time to time, make calls upon the Members in respect of any money unpaid on their Shares (whether on account of the nominal value of the Shares or by way of premium) and not by the conditions of allotment thereof made payable at fixed times, provided that no call shall exceed one-fourth of the nominal value of the Share or be payable at less than 1 (one) month from the date fixed for the payment of the last preceding call.
38. Each Member shall, subject to receiving at least 14 (fourteen) days' notice specifying the time or times and place of payment, pay to the Company, at the time or times and place so specified, the amount called on his Shares.
39. A call may be revoked or postponed at the discretion of the Board.
40. A call shall be deemed to have been made at the time when the resolution of the Board authorising the call was passed and may be required to be paid by instalments.
41. The joint holders of a Share shall be jointly and severally liable to pay all calls in respect thereof.
42. If a sum called in respect of a Share is not paid before or on the day appointed for payment thereof, the Person from whom the sum is due shall pay interest thereof from the day appointed for payment thereof to the time of actual payment at 10 % (ten per cent) per annum or at such lower rate, if any, as the Board may determine.
43. The Board shall be at liberty to waive payment of any such interest wholly or in part.
44. Any sum which by the terms of the issue of a Share becomes payable on allotment or at any fixed date, whether on account of the nominal value of the Share or by way of premium, shall, for the purposes of these Articles, be deemed to be a call duly made and payable on the date on which by the terms of issue, such sum becomes payable. In case of non-payment of such sum, all the relevant provisions of these Articles as to payment of interest and expenses, forfeiture or otherwise shall apply as if such sum had become payable by virtue of a call duly made and notified.

45. The Board may, if it thinks fit, subject to the provisions of Section 50 of the Act, agree to and receive from any Member willing to advance the same, whole or any part of the moneys due upon the Shares held by him beyond the sums actually called for and upon the amount so paid or satisfied in advance, or so much thereof as from time to time exceeds the amount of the calls then made upon the Shares in respect of which such advance has been made, the Company may pay interest at such rate as determined by the Board and the Member paying such sum in advance agree upon, not exceeding 12 (twelve) percent per annum, unless the Members in a General Meeting direct otherwise, provided that money paid in advance of calls shall not confer a right to participate in profits or dividend. The Board may at any time repay the amount so advanced. The Members shall not be entitled to any voting rights in respect of the moneys so paid by him until the same would but for such payment, become presently payable. The provisions of these Articles shall *mutatis mutandis* apply to any calls on debentures of the Company.
46. Where any calls for further Share Capital are made on the Shares of a class, such calls shall be made on a uniform basis on all Shares falling under that class. For the purposes of this Article, Shares of the same nominal value on which different amounts have been paid-up shall not be deemed to fall under the same class.

## **XI. DEMATERIALIZATION OF SHARES**

47. Notwithstanding anything contained in the Articles, the Company shall be entitled to dematerialize its Shares, debentures and other securities and offer such Shares, debentures and other securities in a dematerialized form pursuant to the Depositories Act, 1996 and the regulations made thereunder.
48. Notwithstanding anything contained in the Articles, and subject to the provisions of the Law for the time being in force, the Company shall on a request made by a beneficial owner, re-materialize the Shares, which are in dematerialized form.
49. Every Person subscribing to the Shares offered by the Company shall have the option to receive Share certificates or to hold the Shares with a depository. Where Person opts to hold any Share with the depository, the Company shall intimate such depository of details of allotment of the Shares to enable the depository to enter in its records the name of such Person as the beneficial owner of such Shares. Such a Person who is the beneficial owner of the Shares can at any time opt out of a depository, if permitted by the Law, in respect of any Shares in the manner provided by the Depositories Act, 1996 and the regulations made thereunder and the Company shall in the manner and within the time prescribed, issue to the beneficial owner the required certificate of Shares. In the case of transfer of Shares or other marketable securities where the Company has not issued any certificates and where such Shares or securities are being held in an electronic and fungible form, the provisions of the Depositories Act shall apply.
50. If a Person opts to hold his Shares with a depository, the Company shall intimate such depository the details of allotment of the Shares, and on receipt of the information, the depository shall enter in its record the name of the allottee as the beneficial owner of the Shares.
51. All Shares held by a depository shall be dematerialized and shall be in a fungible form.
- (a) Notwithstanding anything to the contrary contained in the Act or the Articles, a depository shall be deemed to be the registered owner for the purposes of effecting any transfer of ownership of Shares on behalf of the beneficial owner.
- (b) Save as otherwise provided in (a) above, the depository as the registered owner of the Shares shall not have any voting rights or any other rights in respect of Shares held by it.
52. Every Person holding Shares of the Company and whose name is entered as the beneficial owner in the records of the depository shall be deemed to be the owner of such Shares and shall also be deemed to be a Shareholder of the Company. The beneficial owner of the Shares shall be entitled to all the liabilities in respect of his Shares which are held by a depository. The Company shall be further entitled to maintain a register of Members with the details of Members holding Shares both in material and dematerialized form in any medium as permitted by Law including any form of electronic medium.
53. Notwithstanding anything in the Act or the Articles to the contrary, where Shares are held in a depository, the records of the beneficial ownership may be served by such depository on the Company by means of electronic mode or by delivery of disks, drives or any other mode as prescribed by Law from time to time.

54. In the case of transfer of Shares or other marketable Securities where the Company has not issued any certificates and where such Shares or Securities are being held in an electronic and fungible form, the provisions of the Depositories Act, 1996 shall apply.
55. Nothing contained in the Act or the Articles regarding the necessity to have distinctive numbers for securities issued by the Company shall apply to securities held with a depository.

## **XII. LIEN**

56. The Company shall have a first and paramount Lien on: (a) every Share or debenture (not being a fully paid-up Share or debenture) registered in the name of each Member or holder, respectively (whether solely or jointly with others) to the extent of monies called or payable in respect thereof, and upon the proceeds of sale thereof for all monies (whether presently payable or not) called, or payable at a fixed time, in respect of such Share or debenture; and (b) on all Shares or debentures (not being fully paid Shares or debentures) standing registered in the name of a single Person, for all monies presently payable by him or his estate to the Company; and no equitable interest in any Share or debenture shall be created except upon the footing and condition that this Article will have full effect. Fully paid-up Shares shall be free from all Liens and in case of partly paid-up Shares, the Company's Lien shall be restricted to moneys called or payable at a fixed time in respect of such Shares.

Provided that the Board may at any time declare any Shares or debentures wholly or in part to be exempt from the provisions of this Article.

57. The Company's Lien, if any, on a Share shall extend to all dividends or interests as the case may be and bonuses declared and payable by the Company from time to time in respect of such Shares.
58. The Company's Lien, if any, on a debenture shall extend to the interest payable from time to time in respect of such debentures.
59. Subject to the provisions of the Act, the Company may sell, in such manner as the Board thinks fit, any Shares or debenture on which the Company has a Lien, provided that no sale shall be made:
- (a) unless a sum in respect of which the Lien exists is presently payable;
  - (b) until the expiration of 14 (fourteen) days after a notice in writing stating and demanding payment of such part of the amount in respect of which the Lien exists as is presently payable, has been given to the registered Member or holder for the time being of the Share or debenture, or the Person entitled thereto by reason of his death or insolvency.
60. Unless otherwise agreed, the registration of a transfer of Shares or debentures shall operate as a waiver of the Company's Lien, if any, on such Shares or debentures.
61. The following shall apply to any sale of Shares referred to in Article 59 above:
- (a) The Board may authorise some Person to transfer the Shares or debentures sold to the purchaser thereof;
  - (b) The purchaser shall be registered as the holder of the Shares or debentures that are the subject of any such transfer;
  - (c) The purchaser shall not be bound to see to the application of the purchase money, nor shall his title to the Shares be affected by any irregularity or invalidity in the proceedings in reference to the sale;
  - (d) The proceeds of the sale shall be received by the Company and applied in payment of such part of the amount in respect of which the Lien exists as is presently payable;
  - (e) The residue, if any, shall, subject to a like Lien for sums not presently payable as existed upon the Shares or debentures before the sale, be paid to the Person entitled to the Shares or debentures at the date of the sale.
62. A Member shall not exercise any voting rights in respect of the Shares registered in his name on which any calls

or other sums presently payable by him have not been paid in regard to which the Company has exercised the right of Lien.

### **XIII. TRANSFER OF SHARES**

63. The securities or other interest of any Member shall be freely transferable, provided that any contract or arrangement between 2 (two) or more persons in respect of transfer of securities shall be enforceable as a contract. The instrument of transfer of any Share in the Company shall be duly executed by or on behalf of both the transferor and transferee. The transferor shall be deemed to remain a holder of the Share until the name of the transferee is entered in the register of Members in respect thereof. A common form of transfer shall be used in case of transfer of Shares. The instrument of transfer shall be in writing and shall be executed by or on behalf of both the transferor and the transferee and shall be in conformity with all the provisions of Section 56 of the Act and of any statutory modification thereof for the time being and applicable SEBI Regulations shall be duly complied with in respect of all transfers of Shares and the registration thereof. In case of transfer of Shares, where the Company has not issued any certificates and where the Shares are held in dematerialized form, the provisions of the Depositories Act, 1996 shall apply.
64. Subject to the provisions of the Act, these Articles and any other applicable Law for the time being in force, the Directors may, by giving reasons, decline to register or acknowledge any transfer of Shares, not being a fully paid share, to a Person of whom they do not approve, and the right of refusal, shall not be affected by the circumstances that the proposed transferee is already a member of the Company but in such cases, the Directors shall within 30 (thirty) days from the date on which the instrument of transfer was lodged with the Company or such other period prescribed under applicable Law, send to the transferee and transferor, notice of the refusal to register such transfer provided that registration or transfer shall not be refused on the ground of the transferor being either alone or jointly with any other Person or persons indebted to the Company on any account whatsoever except when the Company has a lien on the shares. Transfer of shares/debentures, in whatever lot, shall not be refused.
65. The Board may, subject to the right of appeal conferred by Section 58 of the Act decline to register—
- (a) the transfer of a Share, not being a fully paid Share, to a Person of whom they do not approve; or
  - (b) any transfer of Shares on which the company has a lien.
66. The Board may decline to recognize any instrument of transfer unless—
- (a) the instrument of transfer is in the form as prescribed in rules made under sub-Section (1) of Section 56 of the Act;
  - (b) the instrument of transfer is accompanied by the certificate of the Shares to which it relates, and such other evidence as the Board may reasonably require to show the right of the transferor to make the transfer; and
  - (c) the instrument of transfer is in respect of only one class of Shares.
- Provided that the registration of transfer shall not be refused on the ground of the transferor being either alone or jointly with any other Person or Persons indebted to the Company on any account whatsoever.
67. On giving not less than 7 (seven) days or such other period as may be prescribed under applicable Laws previous notice in accordance with the Act or any other time period as may be specified by Law, the registration of transfers may be suspended at such times and for such periods as the Board may from time to time determine, provided that such registration shall not be suspended for more than 30 (thirty) days or such other period as may be prescribed under applicable Laws at any one time or for more than 45 (forty five) days in the aggregate in any year or such other period as may be prescribed under applicable Laws.
68. No fee shall be charged for registration of transfer, transmission, probate, succession certificate and letters of administration, certificate of death or marriage, power of attorney or similar other document.

### **XIV. TRANSMISSION OF SHARES**

69. On the death of a Member, the survivor or survivors where the Member was a joint holder of the Shares, and his

nominee or nominees or legal representatives where he was a sole holder, shall be the only Person(s) recognised by the Company as having any title to his interest in the Shares. Nothing in these Articles shall release the estate of the deceased joint holder from any liability in respect of any Share, which had been jointly held by him with other persons.

70. Any Person becoming entitled to a Share in consequence of the death or insolvency of a Member may, upon such evidence being produced as the Board may from time to time require, and subject as hereinafter provided, elect, either:
- (a) to be registered as holder of the Share; or
  - (b) to make such transfer of the Share as the deceased or insolvent Member could have made.
71. The Board shall, in either case, have the same right to decline or suspend registration as it would have had, if the deceased or insolvent Member had transferred the Share before his death or insolvency.
72. If the Person so becoming entitled shall elect to be registered as holder of the Shares, such Person shall deliver or send to the Company a notice in writing signed by him stating that he so elects.
73. If the Person aforesaid shall elect to transfer the Share, he shall testify his election by executing an instrument of transfer in accordance with the provisions of these Articles relating to transfer of Shares.
74. All the limitations, restrictions and provisions contained in these Articles relating to the right to transfer and the registration of transfers of Shares shall be applicable to any such notice or transfer as aforesaid as if the death or insolvency of the Member had not occurred and the notice or transfer were a transfer signed by that Member.
75. A Person becoming entitled to a Share by reason of the death or insolvency of the holder shall be entitled to the same dividends and other advantages to which he would be entitled if he were the registered holder of the Share, except that he shall not, before being registered as a Member in respect of the Share, be entitled in respect of it to exercise any right conferred by membership in relation to the General Meetings of the Company, provided that the Board may, at any time, give notice requiring any such Person to elect either to be registered himself or to transfer the Share, and if the notice is not complied with within 90 (ninety) days, the Board may thereafter withhold payment of all dividends, bonuses or other moneys payable in respect of the Share, until the requirements of the notice have been complied with.

## **XV. FORFEITURE OF SHARES**

76. If a Member fails to pay any call, or instalment of a call, on the day appointed for payment thereof, the Board may, at any time thereafter during such time as any part of the call or instalment remains unpaid, serve a notice on him requiring payment of so much of the call or instalment as is unpaid, together with any interest which may have accrued.
77. The notice issued under Article 76 shall:
- (a) name a further day (not being earlier than the expiry of 14 (fourteen) days or such other period as may be prescribed under applicable Laws from the date of service of the notice) on or before which the payment required by the notice is to be made; and
  - (b) state that, in the event of non-payment on or before the day so named, the Shares in respect of which the call was made will be liable to be forfeited.
78. If the requirement of any such notice as aforesaid is not complied with, any Share in respect of which the notice has been given may, at any time thereafter, before the payment required by the notice has been made, be forfeited by a resolution of the Board to that effect.
79. A forfeited Share may be sold or otherwise disposed off on such terms and in such manner as the Board thinks fit.
80. At any time before a sale or disposal as aforesaid, the Board may cancel the forfeiture on such terms as it thinks fit.



81. A Person whose Shares have been forfeited shall cease to be a Member in respect of the forfeited Shares, but shall, notwithstanding the forfeiture, remain liable to pay to the Company all monies which, at the date of forfeiture, were presently payable by the Person to the Company in respect of the Shares.
82. The liability of such Person shall cease if and when the Company shall have received payment in full of all such monies in respect of the Shares.
83. A duly verified declaration in writing that the declarant is a Director, the manager or the secretary of the Company, and that a Share in the Company has been duly forfeited on a date stated in the declaration, shall be conclusive evidence of the facts therein stated as against all Persons claiming to be entitled to the Share.
84. The Company may receive the consideration, if any, given for the Share on any sale or disposal thereof and may execute a transfer of the Share in favour of the Person to whom the Share is sold or otherwise disposed off.
85. The transferee shall there upon be registered as the holder of the Share.
86. The transferee shall not be bound to ascertain or confirm the application of the purchase money, if any, nor shall his title to the Share be affected by any irregularity to invalidity in the proceedings in reference to the forfeiture, sale or disposal of the Share.
87. The provision of these Articles as to forfeiture shall apply in the case of non-payment of any sum which, by the terms of issue of a Share, become payable at a fixed time, whether on account of the nominal value of the Share or by way of premium, as the same had been payable by virtue of a call duly made and notified.

#### **XVI. ALTERATION OF SHARE CAPITAL**

88. Subject to these Articles and the provisions of Section 61 of the Act, the Company may, from time to time, by ordinary resolution, increase the Share Capital by such sum, to be divided into Shares of such amount, as may be specified in the resolution.
89. Subject to the provisions of Section 61 the Act, the Company may from time to time by ordinary resolution, undertake any of the following:
  - (a) consolidate or divide, all or any of the Share Capital into Shares of larger or smaller amount than its existing Shares;
  - (b) convert all or any of its fully paid-up Shares into stock, and re-convert that stock into fully paid-up Shares of any denomination;
  - (c) sub-divide its existing Shares or any number of them into Shares of smaller amount than is fixed by the Memorandum of Association of the Company, so however, that in the sub-division the proportion between the amount paid and the amount, if any, unpaid on each reduced Share shall be the same as it was in the case of the Share from which the reduced Share is derived; or
  - (d) cancel any Shares which, at the date of the passing of the resolution, have not been taken or agreed to be taken by any Person and diminish the amount of Share Capital by the amount of the Shares so cancelled. A cancellation of Shares in pursuance of this Article shall not be deemed to be a reduction of Share Capital within the meaning of the Act.
90. Subject to the provisions of the Act, the Company may, from time to time, by special resolution reduce in any manner and with, and subject to, any incident authorised and consent required under applicable Law:
  - (a) the Share Capital;
  - (b) any capital redemption reserve account; or
  - (c) any Share premium account.

#### **XVII. CONVERSION OF SHARES INTO STOCK**

91. Where Shares are converted into stock:
- (a) the holders of stock may transfer the same or any part thereof in the same manner as and subject to the same Article under which, the Shares from which the stock arose might before the conversion have been transferred, or as near there to as circumstances admit, *provided that* the Board may, from time to time, fix the minimum amount of stock transferable, so however that such minimum shall not exceed the nominal amount of the Shares from which the stock arose;
  - (b) the holders of stock shall, according to the amount of stock held by them, have the same rights, privileges and advantages as regards dividends, voting at meetings of the Company and other matters, as if they held the Shares from which the stock arose; but no such privilege or advantage (except participation in the dividends and profits of the Company and in the assets on winding up) shall be conferred by an amount of the stock which would not, if existing in Shares, have conferred that privilege or advantage; and
  - (c) such of the Articles, as are applicable to paid-up Shares shall apply to stock and the words “*Share*”, “*Shareholder*” and “*Member*” in those Articles shall include “*stock*” and “*stock holder*” respectively.

### **XVIII. GENERAL MEETINGS**

92. An annual General Meeting shall be held each calendar year within the timeline prescribed under Applicable Law. Not more than 15 (fifteen) months or such other period as may be prescribed under applicable Laws shall elapse between the date of one annual General Meeting of the Company and that of the next. Nothing contained in the foregoing provisions shall be taken as affecting the right conferred upon the registrar under the provisions of Section 96 of the Act to extend the time within which any annual General Meeting may be held. Every annual General Meeting shall be called during business hours on a day that is not a national holiday and shall be held either at the registered office or at some other place within the city in which the registered office of the Company is situated, as the Board may determine. Every Member of the Company shall be entitled to attend every General Meeting either in person or by proxy.
93. All General Meetings, other than the annual General Meeting, shall be extra-ordinary General Meetings.
94. No business shall be discussed at any General Meeting except election of a Chairman while the chair is vacant.
95. The Board may, whenever it thinks fit, call an extraordinary general meeting after giving notice as per the Act.
96. The Board shall on the requisition of such number of Members of the Company as is specified in Section 100 of the Act, forthwith proceed to call an extra-ordinary General Meeting of the Company and in respect of any such requisition and of any meeting to be called pursuant thereto, all other provisions of Section 100 of the Act shall for the time being apply.
97. A General Meeting of the Company may be convened by giving not less than clear 21 (twenty-one) days’ notice either in writing or through electronic mode in such manner as prescribed under the Act, provided that a General Meeting may be called after giving a shorter notice if consent, in writing or by electronic mode, is accorded thereto—
- (i) in the case of an annual general meeting, by not less than ninety-five per cent. of the Members entitled to vote thereat; and
  - (ii) in the case of any other general meeting, by Members of the Company holding, majority in number of Members entitled to vote and who represent not less than ninety-five per cent. of such part of the paid-up share capital of the Company as gives a right to vote at the meeting;

Provided further that where any Member of the Company is entitled to vote only on some resolution or resolutions to be moved at a General Meeting and not on the others, those Members shall be taken into account for the abovementioned purposes, in respect of the former resolution or resolutions and not in respect of the latter.

Notice of every General Meeting shall be given to the Members and to such other Person or Persons as required by and in accordance with Section 101 and 102 of the Act and it shall be served in the manner authorized by Section 20 of the Act.

- (iii) Any accidental omission to give notice to, or the non-receipt of such notice by, any Member or other Person who is entitled to such notice for any meeting shall not invalidate the proceedings of the meeting.
- (iv) Subject to the provisions contained under Section 115 of the Act, where, by any provision contained in the Act or in these Articles, special notice is required of any resolution, notice of the intention to move such resolution shall be given to the Company by such number of Members holding not less than one per cent of total voting power or holding Shares on which such aggregate sum not exceeding five lakh rupees, has been paid-up and the Company shall immediately after receipt of the notice, give its members notice of the resolution at least 7 (seven) days before the meeting, exclusive of the day of dispatch of notice and day of the meeting, in the same manner as it gives notice of any General Meetings.

## **XIX. PROCEEDINGS AT GENERAL MEETINGS**

- 98. No business shall be transacted at any General Meeting, unless a quorum of Members is present at the time when the meeting proceeds to transact business. Save as otherwise provided herein, the quorum for the General Meetings shall be as provided in Section 103 of the Act.
- 99. Notwithstanding anything contained elsewhere in these Articles, the Company:
  - (a) shall, in respect of such items of business as the Central Government may, by notification, declare or which are under any other applicable Law required to be transacted only by means of postal ballot; and
  - (b) may, in respect of any item of business, other than ordinary business and any business in respect of which Directors or auditors have a right to be heard at any meeting, transact by means of postal ballot, in such manner as may be prescribed, instead of transacting such business at a General Meeting and any resolution approved by the requisite majority of the Shareholders by means of such postal ballot, shall be deemed to have been duly passed at a General Meeting convened in that behalf and shall have effect accordingly.

Provided that any item of business required to be transacted by means of postal ballot under clause (a) above, may be transacted at a General Meeting by the Company which is required to provide the facility to Members to vote by electronic means under Section 108 of the Act, in the manner provided in that Section.
- 100. Subject to applicable Law, directors may attend and speak at General Meetings, whether or not they are Shareholders.
- 101. A body corporate being a Member shall be deemed to be personally present if it is represented in accordance with Section 113 of the Act and the Articles.
- 102. The Chairman shall preside as chairman at every General Meeting of the Company. If the Chairman is not present within 15 (fifteen) minutes after the time appointed for holding the meeting or is unwilling to act as chairman of the meeting, the Directors present shall choose one of the Directors present to be chairman of the meeting.
- 103. If at any General Meeting no Director is willing to act as chairman or if no Director is present within 15 (fifteen) minutes after the time appointed for holding the General Meeting, the Members present shall choose one of the Members to be chairman of such General Meeting.
- 104. The chairman of a general meeting may, with the consent of Members at any General Meeting at which a quorum is present, and shall, if so directed by the General Meeting, adjourn the General Meeting from time to time and from place to place.
- 105. In the event a quorum as required herein is not present within 30 (thirty) minutes of the appointed time, then subject to the provisions of Section 103 of the Act, the General Meeting shall stand adjourned to the same place and time 7 (seven) days later, provided that the agenda for such adjourned General Meeting shall remain the same. The said General Meeting if called by requisitionists under Article 96 herein read with Section 100 of the Act shall stand cancelled.
- 106. In case of an adjourned meeting or of a change of day, time or place of meeting, the Company shall give not less than 3 (three) days' notice to the Members either individually or by publishing an advertisement in the newspapers (one in English and one in vernacular language) which is in circulation at the place where the registered office of

the Company is situated.

107. No business shall be transacted at any adjourned General Meeting other than the business left unfinished at the General Meeting from which the adjournment took place.
108. When a meeting is adjourned for thirty days or more, notice of the adjourned meeting shall be given as in the case of an original meeting.
109. Save as aforesaid, and as provided in Section 103 of the Act, it shall not be necessary to give any notice of an adjournment or of the business to be transacted at an adjourned General Meeting.
110. Before or on the declaration of the results of the voting on any resolution on a show of hands, a poll may be ordered to be taken by the chairman of the meeting on his/her own motion and shall be ordered to be taken by him/her on a demand made in accordance with Section 109 of the Act.
111. The required quorum at any adjourned General Meeting shall be the same as that required at the original General Meeting.
112. If at the adjourned meeting too, a quorum is not present within 30 (thirty) minutes from the time appointed for holding such meeting, the Members present shall be the quorum and may transact the business for which the meeting was called.
113. Any act or resolution which, under the provision of these Articles or of the Act, is permitted shall be sufficiently so done or passed if effected by an ordinary resolution unless either the Act or these Articles specifically require such act to be done or such resolution passed by a special resolution or by a unanimous approval of all the Members.

## **XX. VOTING RIGHTS**

114. Subject to any rights or restrictions for the time being attached to any class or classes of Shares:
  - (a) on a show of hands, every Member present in person shall have 1 (one) vote; and
  - (b) on a poll, the voting rights of Members shall be in proportion to their share in the paid-up Equity Share Capital.
115. Provided, however, if any preference shareholder be present at any meeting of the Company, save as provided in Section 47 (2) of the Act, he shall have a right to vote only on resolution placed before the meeting which directly affects the right attached to his preference shares.

In the case of an equality of votes, the Chairman shall, on a poll (if any) and e-voting (if applicable), shall not have casting vote in addition to the vote or votes to which he may be entitled as a member.
116. At any General Meeting, a resolution put to vote of the meeting shall be decided per the provisions of the Act and applicable SEBI Regulations, unless a poll is (before or on the declaration of the result of the voting on any resolution on show of hands) demanded by any Member or Members present in person or by proxy, in accordance with applicable Law.
117. Any business other than that upon which a poll has been demanded may be proceeded with, pending the taking of the poll.
118. A Member may exercise his vote at a meeting by electronic means in accordance with Section 108 and shall vote only once. The Company shall also provide E-voting facility to the Shareholders of the Company in terms of the provisions of Act and the Companies (Management and Administration) Rules, 2014 or any other Law, if applicable to the Company.
119. In case of joint holders, the vote of the senior who tenders a vote, whether in person or proxy, shall be accepted to the exclusion of the votes of the other joint holders. For this purpose, seniority shall be determined by the order in which the names are stated in the register of Members of the Company.
120. A Member of unsound mind, or in respect of whom an order has been made by any court having jurisdiction, may

vote, whether on a show of hands or on a poll, by his committee or other legal guardian, and any such committee or guardian may, on a poll, vote by proxy.

121. No Member shall be entitled to exercise any voting rights either personally or by proxy at any General Meeting or meeting of a class of Shareholders either upon a show of hands or upon a poll in respect of any Shares registered in his/her name on which any calls or other sums presently payable by him in respect of Shares in the Company have not been paid.
122. No objection shall be raised to the qualification of any voter except at the General Meeting or adjourned General Meeting at which the vote objected to is given or tendered, and every vote not disallowed at such General Meeting and whether given personally or by proxy or otherwise shall be deemed valid for all purpose.
123. Any such objection made in due time shall be referred to the chairman of the General Meeting whose decision shall be final and conclusive.
124. A declaration by the chairman of the meeting of the passing of a resolution or otherwise by show of hands and an entry to that effect in the books containing the minutes of the meeting of the Company shall be conclusive evidence of the fact of passing of such resolution or otherwise.
125. Any poll duly demanded on the question of adjournment shall be taken forthwith. A poll demanded on any other question (not being a question relating to the election of a chairman for the meeting or adjournment of the meeting) shall be taken at such time not exceeding 48 hours from the time when the demand was made, as the Chairman may direct.
126. The chairman of a General Meeting, may with the consent of the meeting, adjourn the same from time to time and from place to place, but no business shall be transacted at any adjourned meeting other than the business left unfinished at the meeting from which the adjournment took place.
127. The demand of a poll shall not prevent the continuance of a meeting for the transaction of any business other than the question of which a poll has been demanded.
128. Where a poll is to be taken, the chairman of the general meeting shall appoint two scrutinisers to scrutinise the votes given on the poll and to report thereon to him/her in accordance with Section 109 of the Act.
129. The chairman the meeting shall have power, at any time before the result of the poll is declared to remove a scrutiniser from office and to fill vacancies in the office of scrutiniser arising from such removal or from any other cause.
130. The chairman of the meeting shall have power to regulate the manner in which a poll shall be taken.
131. The result of the poll shall be deemed to be decision of the meeting on the resolution on which the poll was taken.
132. The chairman of any meeting shall be the sole judge of the validity of every vote tendered at such meeting.
133. On a poll taken at meeting of the Company, a member entitled to more than one vote, or his proxy or other person entitled to vote for him, as the case may be, need not, if he votes, use all his votes or cast in the same way all the votes he uses.
134. Where a resolution is passed at an adjourned meeting of the Company, the resolution shall, for all purposes, be treated as having been passed on the date on which it was in fact passed and shall not be deemed to have been passed on any earlier date.

## **XXI.PROXY**

135. Subject to the provisions of the Act and these Articles, any Member of the Company entitled to attend and vote at a General Meeting of the Company shall be entitled to appoint a proxy to attend and vote instead of himself and the Proxy so appointed shall have no right to speak at the meeting.
136. The proxy shall not be entitled to vote except on a poll.

137. The instrument appointing a proxy and the power of attorney or other authority, if any, under which it is signed or a notarised copy of that power or authority, shall be deposited at the registered office of the Company not less than 48 (forty eight) hours before the time for holding the meeting or adjourned meeting at which the Person named in the instrument proposes to vote; or in the case of a poll, not less than 24 (twenty four) hours before the time appointed for the taking of the poll; and in default the instrument of proxy shall not be treated as valid.
138. An instrument appointing a proxy shall be in the form as prescribed under Section 105 the Act and the rules framed thereunder.
139. A vote given in accordance with the terms of an instrument of proxy shall be valid, notwithstanding the previous death or insanity of the principal or the revocation of the proxy or of the authority under which the proxy was executed, or the transfer of the Shares in respect of which the proxy is given; provided that no intimation in writing of such death, insanity, revocation or transfer shall have been received by the Company at its office before the commencement of the meeting or the adjourned meeting at which the proxy is used.

## **XXII. BOARD OF DIRECTORS**

140. The Board shall comprise of a minimum of six directors and a maximum of 15, with a right for shareholders to increase such number of directors in accordance with the Articles and the Act.

141. Investor Director:

At any time on and after the commencement of listing and trading of the Equity Shares on a recognised stock exchange (“**Trading Date**”) until such time that the Investor (together with its affiliates) continues to hold at least 5% (five per cent) of the issued and share capital of the Company (on a fully diluted basis), the Investor (together with its affiliates) shall have the right but not the obligation to nominate 1 (one) Director to the Board of the Company. Provided that this right will be available to the Investor subject to the approval of Shareholders by way of a Special Resolution in the first General Meeting of the Company convened after the Trading Date.

142. Subject to the provisions of the Act, two-thirds of the total number of Directors of the Company (other than independent Directors) shall be persons whose period of office is liable to determination by retirement of directors by rotation, subject to the below conditions:
- i. At every annual General Meeting of the Company, one-third of such of the Directors for the time being as are liable to retire by rotation pursuant to applicable Law or if their number is not three or a multiple of three, the number nearest to one-third shall retire from office.
  - ii. Subject to Section 152(6)(d) of the Act, the Directors to retire by rotation at every annual General Meeting shall be those who have been longest in office since their last appointment, but as between Persons who become Directors on the same day, those who are to retire, shall, in default of and subject to any agreement amount themselves, be determined by lot.
  - iii. A retiring Director shall be eligible for re-election.
  - iv. Subject to Sections 152(6)(e) and 152(7)(a) of the Act and these Articles, the Company at the General Meeting at which a Director retires in a manner aforesaid may fill up the vacated office by electing a Person thereto.
  - v. If the place of the retiring Director is not so filled up and the meeting has not expressly resolved not to fill the vacancy, the meeting shall stand adjourned till the same day in the next week, at the same time and place, or if that day is a national holiday, till the next succeeding day which is not a national holiday, at the same time and place.
  - vi. If at the adjourned meeting also, the place of the retiring Director is not filled up and that meeting also has not expressly resolved not to fill the vacancy, then the retiring Director shall be deemed to have been reappointed at the adjourned meeting, unless:
    - a. at that meeting or at the previous meeting a resolution for the reappointment of such Director has been put to the meeting and lost;
    - b. the retiring Director has, by a notice in writing addressed to the Company or its Board, expressed his

- unwillingness to be so reappointed;
  - c. the retiring Director is not qualified or is disqualified for appointment; or
  - d. a resolution whether special or ordinary is required for the appointment or reappointment by virtue of any applicable provisions of the Act.
- vii. It is clarified for the avoidance of doubt that the Chairman shall not be liable to retire by rotation, except in order to comply with Applicable Law.
143. Subject to Section 197 and other applicable provisions of the Act, the remuneration of Directors may be a fixed sum by way of monthly payment or a percentage of the net profits or partly by one way and partly by the other.
144. Subject to the provisions of the Act, every Director shall be paid out of the funds of the Company such sum as the Board may from time to time determine for attending every meeting of the Board or any committee of the Board, subject to the ceiling prescribed under the Act.
145. In addition to the remuneration payable to them in pursuance of the Act, the Directors may also be paid all travelling, hotel and other expenses properly incurred by them in attending and returning from meeting of the Board or any committee thereof or General Meetings of the Company and any other expenses properly incurred by them in connection with the business of the Company. If authorized by the Board, the Directors may also be remunerated for any extra services done by them outside their ordinary duties as Directors, subject to the applicable provisions of the Act.
146. A Director shall not be required to hold any qualification shares in the Company.
147. No Person shall be appointed as a Director unless he furnishes to the Company his Director Identification Number under Section 154 of the Act or any other number as may be prescribed under Section 153 of the Act and a declaration that he is not disqualified to become a Director under the Act.
148. Subject to the provisions of the Act, the Board shall have power at any time, and from time to time, to appoint any other Person as an additional director provided that the number of the Directors and additional Directors together shall not at any time exceed the maximum number fixed as above and any Person so appointed as an additional Director shall retain his office only up to the date of the next annual General Meeting or last date on which the annual General Meeting should have been held, whichever is earlier, but shall then be eligible for re-appointment as Director of the Company.
149. In the event that a Director is absent for a continuous period of not less than 3 (three) months or such other period as prescribed under applicable Laws from India (an “**Original Director**”), subject to these Articles and the provisions of the Act, the Board may appoint another Person (an “**Alternate Director**”) for and in place of the Original Director. The Alternate Director shall be entitled to receive notice of all meetings and to attend and vote at such meetings in place of the Original Director and generally to perform all functions of the Original Director in the Original Director’s absence. No Person shall be appointed as an Alternate Director to an independent Director unless such Person is qualified to be appointed as an independent Director of the Company. Any Person so appointed as Alternate Director shall not hold office for a period longer than that permissible to the Original Director and shall vacate the office if and when the Original Director returns to India. If the term of the office of the Original Director is determined before he so returns to India, any provisions in the Act or in these Articles for automatic re-appointment shall apply to the Original Director and not to the Alternate Director.
150. The office of a Director shall automatically become vacant, if he is disqualified under any of the provisions of the Act or the rules framed thereunder. Further, subject to the provisions of the Act, a Director may resign from his office at any time by giving a notice in writing addressed to the Board and the Company shall intimate the registrar and also place the fact of such resignation in the report of Directors laid in the immediately following General Meeting. Subject to the Act, such Director may also forward a copy of his resignation along with detailed reasons for the resignation to the registrar within 30 (thirty) days or such other period as may be prescribed under applicable Laws of resignation. The resignation of a Director shall take effect from the date on which the notice is received by the Company or the date, if any, specified by the Director in the notice, whichever is later. The Company may, subject to the provisions of Section 169 and other applicable provisions of the Act and these Articles remove any Director before the expiry of his period of office.
151. At any annual General Meeting at which a Director retires, the Company may fill up the vacancy by appointing the retiring Director who is eligible for re-election or some other Person if a notice for the said purpose has been left

at the office of the Company in accordance with the provisions of the Act.

152. If the office of any Director appointed by the Company in General Meeting is vacated before his term of office expires in the normal course, the resulting casual vacancy may, be filled by the Board of Directors at a meeting of the Board which shall be subsequently approved by Members in the immediate next General Meeting. Provided any Person so appointed shall hold office only up to the date up to which the Director in whose place he is appointed would have held office if it had not been vacated.
153. In the event of the Company borrowing any money from any financial corporation or institution or government or any government body or a collaborator, bank, Person or Persons or from any other source, while any money remains due to them or any of them, the lender concerned may have and may exercise the right and power to appoint, from time to time, any Person or Persons to be a Director or Directors of the Company and the Directors so appointed, shall not be liable to retire by rotation, subject however, to the limits prescribed by the Act. Any Person so appointed may at any time be removed from the office by the appointing authority who may from the time of such removal or in case of death or resignation of such Person, appoint any other or others in his place. Any such appointment or removal shall be in writing, signed by the appointee and served on the Company. Such Director need not hold any qualification shares.

### **XXIII. PROCEEDINGS OF THE BOARD**

154. The Board may meet for the conduct of business and may adjourn and otherwise regulate its meetings, as it thinks fit.
155. A Director may and the manager or secretary on the requisition of a Director shall, at any time, summon a meeting of the Board.
156. Subject to requirements under applicable Law, a minimum number of 4 (four) Board meetings shall be held every year in such a manner that not more than 120 (one hundred and twenty) days shall intervene between 2 (two) consecutive meetings of the Board, in accordance with the provisions of the Act.
157. Subject to the provisions of the Act and the rules framed thereunder, all or any of the Directors or members of any committee of the Board may participate in a meeting of the Directors or such committee through video conferencing or other audio-visual means.
158. No business shall be conducted at any meeting of the Directors unless a quorum is present. The quorum for the meeting of the Board shall be one third of its total strength or 2 (two) Directors, whichever is higher, and the participation of the Directors by video conferencing or by other audio-visual means or any other means (to the extent permitted under the Act and the rules framed thereunder or otherwise provided by the Ministry of Corporate Affairs), in each case from time to time, shall also be counted for the purposes of quorum under this Article, provided that where at any time the number of interested Directors is equal to or exceeds two-thirds of the total strength of the Board, the number of remaining Directors, that is to say the number of Directors who are not interested and present at the meeting being not less than 2 (two), shall be the quorum during such time.
159. If quorum is found to be not present within 30 (thirty) minutes from the time when the meeting should have begun or if during the meeting, valid quorum no longer exists, the meeting shall be reconvened at the same time and at the same place 7 (seven) days later. At the reconvened meeting, the Directors present and not being less than 2 (two) persons shall constitute the quorum and may transact the business for which the meeting was called and any resolution duly passed at such meeting shall be valid and binding on the Company.
160. The continuing Directors may act notwithstanding any vacancy in the Board; but if and so long as their number is reduced below the quorum fixed by the Act for a meeting of the Board, the continuing Directors or Director may act for the purpose of increasing the number of Directors to that fixed for the quorum, or of summoning a General Meeting of the Company, but for no other purpose.
161. Subject to the provisions of the Act and the rules framed thereunder allowing for shorter notice periods, a meeting of the Board shall be convened by giving not less than 7 (seven) days' notice in writing to every Director. Each notice of a Board meeting shall:
  - (a) specify a reasonably detailed agenda. Unless waived in writing by all Directors, any item not included in the agenda of a meeting shall not be considered or voted upon at that meeting of the Board;



- (b) be accompanied by any relevant supporting papers; and
  - (c) be sent by: (i) courier if sent to an address in India; (ii) by e-mail or facsimile transmission if sent to an address outside India; or by hand delivery.
162. Save as otherwise expressly provided in the Act or these Articles, questions arising at any meeting of the Board shall be decided by a majority of votes.
163. The Chairman of the Company and of the Board shall be selected from among the Directors of the Board and shall be elected by the Promoter subject to such right being approved by the Shareholders through a Special Resolution in the first General Meeting of the Company held post the Trading Date. Subject to applicable Law, the same individual may be appointed as the managing Director and/or the chief executive officer of the Company. If at any meeting the Chairman is not present within 15 (fifteen) minutes after the time appointed for holding the meeting, the Directors present may choose one of their number to be the chairman of the meeting.
164. The Chairman, shall not have any second or casting vote.
165. Subject to these Articles and Sections 175, 179 and other applicable provisions of the Act, a circular resolution in writing, executed by or on behalf of a majority of the Directors or members of a committee, shall constitute a valid decision of the Board or committee thereof, as the case may be, as if it had been passed at a meeting of the Board or committee, duly convened and held, provided that a draft of such resolution together with the information required to make a fully-informed good faith decision with respect to such resolution and appropriate documents required to evidence passage of such resolution, if any, was sent to all of the Directors or members of the committee (as the case may be) at their addresses registered with the Company in India by hand delivery or by post or by courier, or through such electronic means as may be prescribed under the Act, and has been approved by a majority of the Directors or members who are entitled to vote on the resolution.
166. The Board shall constitute the statutory committees in accordance with applicable Law. Subject to provisions of the Act, the Board may delegate any of its powers to committees consisting of such Director or Directors as it thinks fit.
167. Any committee so formed shall, in the exercise of the powers so delegated, conform to any regulations that may be imposed on it by the Board.
168. Subject to applicable Law and these Articles, a committee may elect a chairman of its meetings.
169. If no such chairman is elected, or if at any meeting the chairman is not present within 5 (five) minutes after the time appointed for holding the meeting, the Directors present may choose one of themselves to be the chairman of the meeting.
170. A committee may meet and adjourn as it thinks fit.
171. Questions arising at any meeting of a committee shall be determined by a majority of votes of the Directors present. The chairman of the committee, if any, shall not have any second or casting vote.
172. Every Director shall at the first meeting of the Board in which he participates as a Director and thereafter at the first meeting of the Board in every financial year or whenever there is any change in the disclosures already made, then the first meeting held after such change, disclose his concern or interest in any company, companies or bodies corporate, firms or other associations of individuals which shall include the shareholding in such manner as may be prescribed under the Act and the rules framed thereunder.
173. Subject to the provisions of the Act, no Director shall be disqualified by his office from contracting with the Company nor shall any such contract entered into by or on behalf of the Company in which any Director shall be in any way interested be avoided, nor shall any Director contracting or being so interested be liable to account to the Company for any profit realized by any such contract by reason only of such Director holding that office or of the fiduciary relations thereby established provided that every Director who is in any way whether directly or indirectly concerned or interested in a contract or arrangement, entered into or to be entered into by or on behalf of the Company, shall disclose the nature of his concern or interest at a meeting of the Board and shall not participate in such meeting as required under Section 184 and other applicable provisions of the Act, and his presence shall

not count for the purposes of forming a quorum at the time of such discussion or vote.

174. All acts done in any meeting of the Board or of a committee thereof or by any Person acting as a Director, shall, notwithstanding that it may be afterwards discovered that there was some defect in the appointment of any one or more of such Directors or of any Person acting as aforesaid or that they or any of them were disqualified, be as valid as if every such Director or such Person had been duly appointed and was qualified to be a Director.
175. Every Director present at any meeting of the Board or of a committee thereof shall sign his name in a book to be kept for that purpose.
176. Minutes of each meeting of the Board shall be circulated to all Directors.

#### **XXIV. POWERS OF DIRECTORS**

177. The business of the Company shall be vested in the Board of Directors and the Board shall be responsible for the overall direction and management of the Company. Subject to the provisions of the Act, the Board shall have the right to delegate any of their powers to such committee of Directors, managing director, managers, agents or other persons as they may deem fit and may at their own discretion revoke such powers.
178. Subject to the provisions of the Act and these Articles, the Board shall be entitled to exercise all such powers, and to do all such acts and things as the Company is authorized to exercise and do; provided that the Board shall not exercise any power or do any act or thing which is directed or required, whether by the Act, or any other statute or by the Memorandum of Association of the Company or by these Articles or otherwise, to be exercised or done by the Company in a General Meeting; provided further that in exercising any such power or doing any such act or thing, the Board shall be subject to the provisions in that behalf contained in the Act or any other statute or in the Memorandum of Association of the Company or in these Articles, or in any regulations not inconsistent therewith and duly made thereunder, including regulations made by the Company in General Meeting, but no regulation made by the Company in General Meeting shall invalidate any prior act of the Board which would have been valid if that regulation had not been made.
179. The Board of Directors shall, or shall authorize persons in their behalf, to make necessary filings with Governmental Authorities in accordance with the Act and other applicable Law, as may be required from time to time.
180. The Directors shall have the power to open and close bank accounts and operate the same generally, to sign cheques on behalf of the Company and to receive payments, make endorsements, draw and accept negotiable instruments, hundies and bills or may authorize any other Person or persons to exercise such powers.

#### **XXV. MANAGING/WHOLE-TIME DIRECTORS AND KEY MANAGERIAL PERSONNEL**

181. Subject to the provisions of the Act, the Board may from time to time appoint one or more Directors to be the managing Director/ whole-time Director of the Company on such remuneration and terms and conditions as the Board may think fit, and for a fixed term or without any limitation as to the period for which he is to hold such office and from time to time and subject to the provisions of any contract between him and the Company, remove or dismiss him from office and appoint another in his place. Subject to the provisions of the Act, in particular to the prohibitions and restrictions contained in Section 179 thereof, the Board may, from time to time, entrust to and confer upon the managing Director / whole-time Director, for the time being, such of the powers exercisable hereunder by the Board, as it may think fit, and may confer such powers, for such time and be exercised for such objects and purposes, and upon such terms and conditions and with such restrictions as it thinks fit, and the Board may confer such power, either collaterally with or to the exclusion of, and in substitution for any of the powers of the Board in that behalf and may, from time to time, revoke, withdraw, alter or vary all or any of such powers.
182. Subject to the provisions of any contract between him and the Company, the managing Director/ whole-time director, shall be subject to the same provisions as to resignation and removal as the other Directors and shall ipso facto and immediately cease to be the managing Director if he ceases to hold the office of Director for any cause.
183. Subject to the provisions of the Act, the managing Director/whole-time Director shall, in addition to the remuneration payable to him as a Director of the Company, receive such remuneration as may be sanctioned by the Board from time to time and such remuneration may be fixed by way of salary or bonus or commission or participation in profit, or perquisites and benefits or by some or all of these modes.

184. Subject to the provisions of the Act, a chief executive officer, manager, company secretary or chief financial officer or any other key managerial personnel not more than one level below the Board and in the whole time employment of the Company and designated as a key managerial personnel may be appointed by the Board for such term, at such remuneration and upon such conditions as it may think fit; and any chief executive officer, manager, company secretary, chief financial officer or any other Key Managerial Personnel so appointed may be removed by means of a resolution of the Board.
185. A Director may be appointed as chief executive officer, manager, company secretary or chief financial officer.
186. Any provision of the Act or these Articles requiring or authorising a thing to be done by or to a Director and managing director, chief executive officer, manager, company secretary or chief financial officer shall not be satisfied by its being done by or to the same Person acting both as Director and as, or in place of, managing director, chief executive officer, manager, company secretary or chief financial officer.

## **XXVI. BORROWING POWERS**

187. Subject to the provisions of the Act, the Board may from time to time, at their discretion raise or borrow or secure the payment of any sum or sums of money for and on behalf of the Company from the Members or from other persons, companies or banks. Any such money may be raised or the payment or repayment thereof may be secured in such manner and upon such terms and conditions in all respect as the Board may think fit by promissory notes or by opening loan or current accounts or by receiving deposits and advances at interest with or without security or otherwise and in particular by the issue of bonds, perpetual or redeemable debentures of the Company charged upon all or any part of the property of the Company (both present and future) including its uncalled capital for the time being or by mortgaging or charging or pledging any lands, buildings, machinery, plant, goods or other property and securities of the Company or by other means as the Board deems expedient.
188. The Board of Directors shall not except with the consent of the Company by way of a special resolution, borrow moneys where the moneys to be borrowed together with the moneys already borrowed by the Company (apart from temporary loans obtained from the Company's bankers in the ordinary course of business) exceeds the aggregate of paid-up capital of the Company, its free reserves and securities premium.
189. Subject to the Act and the provisions of these Articles, any bonds, debentures, debenture-stock or other securities issued or to be issued by the Company shall be under the control of the Board, who may issue them upon such terms and conditions and in such manner and for such consideration as the Board shall consider to be for the benefit of the Company.

## **XXVII. THE SEAL**

190. The Board of Directors may select a seal for the Company and shall provide by resolution for the safe custody and affixing thereof.
191. The seal, if any, shall not be affixed to any instrument except by the authority of a resolution of the Board or a committee of the Board authorised by it in that behalf, and except in the presence of such persons as the Board may authorise for the purpose and as may be required under applicable Law.

## **XXVIII. DIVIDENDS AND RESERVES**

192. The Company in a General Meeting may declare dividends, but no dividend shall exceed the amount recommended by the Board. No dividend shall be payable except out of the profits of the Company or any other undistributed profits.
193. Subject to the provisions of Section 123 of the Act, the Board may from time to time pay to the Members such dividends including interim dividends as appear to it to be justified by the profits of the Company.
194. The Board may, before recommending any dividend, set aside out of the profits of the Company such sums as it thinks fit as a reserve or reserves which shall, at the discretion of the Board, be applicable for any purpose to which the profits of the Company may be properly applied, including provision for meeting contingencies or for equalising dividends; and pending such application, may, at the like discretion, either be employed in the business of the Company or be invested in such investments (other than shares of the Company) as the Board

may, from time to time, think fit. The Board may also carry forward any profits which it may consider necessary not to divide, without setting them aside as a reserve.

195. Subject to the rights of persons, if any, entitled to Shares with special rights as to dividends, all dividends shall be declared and paid according to the amounts paid or credited as paid on the Shares in respect whereof the dividend is paid, but if and so long as nothing is paid upon any of the Shares in the Company, dividends may be declared and paid according to the amounts of the Shares.
196. No amount paid or credited as paid on a Share in advance of calls shall be treated for the purpose of these Articles as paid on the Share.
197. All dividends shall be apportioned and paid proportionately to the amounts, paid or credited as paid on the Shares during any portion or portions of the period in respect of which the dividend is paid, but if any Share is issued on terms providing that it shall rank for dividend as from a particular date such Share shall rank for dividend accordingly.
198. The Board may deduct from any dividend payable to any Member all sums of money, if any, presently payable by him to the Company on account of calls or otherwise in relation to the Shares.
199. Any dividend, interest or other monies payable in cash in respect of Shares may be paid by electronic mode or by cheque or warrant sent through the post directed to the registered address of the holder or, in the case of joint holders, to the registered address of that one of the joint holders who is first named on the register of Members of the Company, or to such Person and to such address as the holder or joint holders may in writing direct.
200. Every such cheque or warrant shall be made payable to the order of the Person to whom it is sent.
201. Any one of two or more joint holders of a Share may give effectual receipts for any dividends, bonuses or other payments in respect of such Share.
202. Notice of any dividend, whether interim or otherwise, that may have been declared shall be given to the Persons entitled to share therein in the manner mentioned in the Act.
203. No dividend shall bear interest against the Company.
204. Nothing herein shall be deemed to prohibit the capitalization of profits or reserves of the Company for the purpose of issuing fully paid-up bonus Shares or paying up any amount for the time being unpaid on any Shares held by the Members of the Company.
205. The Company shall comply with the provisions of the Act in respect of any dividend remaining unpaid or unclaimed with the Company. Where the Company has declared a dividend but which has not been paid or claimed within 30 (thirty) days from the date of declaration, the Company shall, within 7 (seven) days from the date of expiry of the 30 (thirty) day period, transfer the total amount of dividend which remains so unpaid or unclaimed, to a special account to be opened by the Company in that behalf in any scheduled bank. Any money transferred to the unpaid dividend account of the Company which remains unpaid or unclaimed for a period of 7 (seven) years or such other period as prescribed under applicable Law from the date of such transfer, shall be transferred by the Company along with interest accrued, if any, thereon to the Investor Education and Protection Fund established under Section 125 of the Act. No unclaimed or unpaid dividend shall be forfeited by the Board before claim on such dividend becomes barred by applicable Law.

## **XXIX. CAPITALISATION OF PROFITS**

206. The Company in a General Meeting may, upon the recommendation of the Board, resolve:
  - (a) that it is desirable to capitalise any part of the amount for the time being standing to the credit of any of the Company's reserve accounts or to the credit of the profit and loss account, or otherwise available for distribution; and
  - (b) that such sum be accordingly set free for distribution in the manner specified in these Articles and applicable Law amongst the Members who would have been entitled thereto, if distributed by way of dividend and in the same proportions.

207. The sum aforesaid shall not be paid in cash but shall be applied, subject to the provision contained in these Articles below, either in or towards:
- (a) paying up any amounts for the time being unpaid on any Shares held by such Members respectively;
  - (b) paying up in full, unissued Shares of the Company to be allotted and distributed, credited as fully paid up, to and amongst such Members in the proportions aforesaid; or
  - (c) Partly in the way specified in sub-Article (a) and partly in that specified in sub-Article (b) above.
  - (d) A securities premium account and a capital redemption reserve account may, for the purposes of this Article, be applied in the paying up of unissued Shares to be issued to Members of the Company as fully paid bonus Shares.
  - (e) The Board shall give effect to the resolution passed by the Company in pursuance of this Article.
208. Whenever such a resolution as aforesaid shall have been passed, the Board shall:
- (a) make all appropriations and applications of the undivided profits resolved to be capitalised thereby, and all allotments and issues of fully paid Shares, if any; and
  - (b) generally do all acts and things required to give effect thereto.
209. The Board shall have power to:
- (a) make such provision, by the issue of fractional certificates or by payment in cash or otherwise as it thinks fit, for the case of Shares or debentures becoming distributable in fractions; and
  - (b) authorise any Person to enter, on behalf of all the Members entitled thereto, into an agreement with the Company providing for the allotment to them respectively, credited as fully paid up, of any further Shares to which they may be entitled upon such capitalisation, or (as the case may require) for the payment by the Company on their behalf, by the application thereto of their respective proportions of profits resolved to be capitalised, of the amount or any part of the amounts remaining unpaid on their existing Shares.
210. Any agreement made under such authority shall be effective and binding on such Members.

### **XXX. INDEMNITY**

211. Subject to the provisions of the Act, every Director, secretary and the other officers for the time being of the Company acting in relation to any of the affairs of the Company shall be indemnified out of the assets of the Company from and against all suits, proceedings, cost, charges, losses, damage and expenses, whether civil or criminal, in which judgement is granted in his favour or in which he is acquitted, or in which he is acquitted or in which relief is granted to him by the court or the Tribunal, which they or any of them shall or may incur or sustain by reason of any act done or committed in or about the execution of their duty in their respective office except such suits, proceedings, cost, charges, losses, damage and expenses, if any that they shall incur or sustain, by or through their own wilful neglect or default respectively.
212. The Company may take and maintain any insurance as the Board may think fit on behalf of its present and/or former Directors and key managerial personnel for indemnifying all or any of them against any liability for any acts in relation to the Company for which they may be liable but have acted honestly or reasonably.

### **XXXI. ACCOUNTS**

213. Subject to the provisions of the Act, the Company shall keep at its registered office, proper books of accounts and other relevant books and papers and financial statement for every financial year which give a true and fair view of the state of the affairs of the Company, including that of its branch office or offices, if any, and explain the transactions effected both at the registered office and its branches and such books shall be kept on accrual basis and according to the double entry system of accounting, provided that all or any of the books of account aforesaid may be kept at such other place in India as the Board may decide and when the Board so decides the Company

shall, within 7 (seven) days of the decision or such other period prescribed under applicable Law file with the registrar a notice in writing giving the full address of that other place, provided further that the Company may keep such books of accounts or other relevant papers in electronic mode in such manner as provided in Section 128 of the Act and the rules framed thereunder.

214. The Board shall from time to time determine whether and to what extent and at what times and places and under what conditions or regulations, the accounts or books or documents of the Company, or any of them, shall be open to inspection by the Members not being Directors subject to provisions of the Act and these Articles. Each Director shall be entitled to examine the books, accounts and records of the Company, and shall have free access, at all reasonable times and with prior written notice, to any and all properties and facilities of the Company. The Company shall provide such information relating to the business, affairs and financial position of the Company as any Director may reasonably require.
215. No member (not being a Director) shall have any right of inspecting any account or book or document of the Company except as conferred by Law or authorised by the Board or by the Company in General Meeting.
216. The books of accounts of the Company relating to a period of not less than 8 (eight) financial years immediately preceding the current year or such other period prescribed under applicable Laws together with the vouchers relevant to any entry in such books of account shall be preserved in good order.

### **XXXII. AUDIT**

217. The statutory auditors of the company shall be appointed, their remuneration shall be fixed, rights, duties and liabilities shall be regulated and their qualifications and disqualifications shall be in accordance with the provisions of Sections 139 to 148 (both inclusive) of the Act.
218. The Directors may fill up any casual vacancy in the office of the auditors within 30 (thirty) days subject to the provisions of Sections 139 and 140 of the Act and the rules framed thereunder.
219. The remuneration of the auditors shall be fixed by the Company in the annual General Meeting or in such a manner as the Company in the annual General Meeting may determine except that, subject to the applicable provisions of the Act, remuneration of the first auditor appointed by the Directors may be fixed by the Directors.
220. The Company shall also appoint a reputed accounting firm as the internal auditor to conduct internal audit of the functions and activities of the Company in accordance with the provisions of the Act.

### **XXXIII. SECRECY**

221. Subject to the provisions of the Act, no Member shall be entitled to visit or inspect any work of the Company without the permission of the Directors, managing directors or secretary or to require inspection of any books of accounts or documents of the Company or any discovery of any information or any detail of the Company's business or any other matter, which is or may be in the nature of a trade secret, mystery of secret process or which may relate to the conduct of the business of the Company and which in the opinion of the Directors or the managing Director will be inexpedient in the collective interests of the Members of the Company to communicate to the public or any Member.
222. Every Director, manager, secretary, auditor, trustee, member of committee, officer, servant, agent, accountant or other Person employed in the business of the Company will be upon entering his duties pledging himself to observe strict secrecy in respect of all matters of the Company including all transaction with customers, state of accounts with individual and other matters relating thereto and to not reveal any of the matters which may come to his knowledge in the discharge of his duties except when required so to do by the Directors or by any meeting or by a court of Law and except so far as may be necessary in order to comply with any of the provisions in these Articles and the provisions of the Act.
223. Post listing of the Equity Shares, at the request of any Shareholder, the Company shall provide to such Shareholder: (i) annual reports; (ii) annual, semi-annual, quarterly and other periodic financial statements and reports; (iii) any other interim or extraordinary reports; and (iv) prospectuses, registration statements, offering circulars, offering memoranda and other document relating to any offering of securities by the Company, provided, in each case, that (a) the Company has, prior to providing any Shareholder with such information, made such information available to the public; and (b) the Company is not prohibited under any applicable Law

from providing such information to such Shareholder.

#### **XXXIV. WINDING UP**

224. The Company may be wound up in accordance with the Act and the Insolvency and Bankruptcy Code, 2016, as amended (to the extent applicable).
225. Subject to the provisions of Chapter XX of the Act and rules made thereunder:
- (i) If the Company shall be wound up, the liquidator may, with the sanction of a special resolution of the Company and any other sanction required by the Act, divide amongst the Members, in specie or kind, the whole or any part of the assets of the Company, whether they shall consist of property of the same kind or not.
  - (ii) For the purpose aforesaid, the liquidator may set such value as he deems fair upon any property to be divided as aforesaid and may determine how such division shall be carried out as between the Members or different classes of Members.
  - (iii) The liquidator may, with the like sanction, vest the whole or any part of such assets in trustees upon such trusts for the benefit of the contributories if he considers necessary, but so that no member shall be compelled to accept any shares or other securities whereon there is any liability.

#### **XXXV. GENERAL AUTHORITY**

226. Wherever in the Act, it has been provided that the Company shall have any right, privilege or authority or that the Company cannot carry out any transaction unless the Company is so authorized by its Articles then in that case, these Articles hereby authorize and empower the Company to have such rights, privilege or authority and to carry out such transaction as have been permitted by the Act, without there being any specific Article in that behalf provided.
227. At any point of time from the date of adoption of these Articles, if the Articles are or become contrary to the provisions of the Securities and Exchange Board of India (Listing Obligations and Disclosure Requirements) Regulations, 2015, as amended (the “**Listing Regulations**”) and the Act, as amended, the provisions of the Listing Regulations and the Act shall prevail over the Articles to such extent and the Company shall discharge all of its obligations as prescribed under the Listing Regulations and the Act, from time to time.

### **PART II OF THE ARTICLES OF ASSOCIATION**

#### **1. INTERPRETATION AND PRELIMINARY<sup>1</sup>**

The provisions contained in these Articles shall have an overriding effect on the provisions contained in the previously existing Articles of Association of the Company.

Regulations contained in Table F to the First Schedule to the Companies Act, 2013, shall apply to the Company only so far as they are not inconsistent with any of the provisions contained in these Articles, but in case of variation or inconsistency between these Articles and Table “F”, these Articles shall prevail.

Unless defined in these Articles or the context otherwise requires, words or expressions contained in these regulations shall bear the same meaning as in the Companies Act, 2013 or any statutory modification thereof in force at the date at which these regulations become binding on the Company. All capitalized words used in these regulations but not defined shall have the meanings assigned to them under these Articles.

#### **2. DEFINITIONS**

In the Articles of Association, unless the contrary intention appears, the following terms will have the meanings set forth below. Capitalised terms used but not defined herein shall have the meanings as ascribed to such terms under the Transaction Documents.

---

<sup>1</sup> Article 1 has been amended by passing special resolution at an Extra-Ordinary General of Members held on 10<sup>th</sup> November, 2021.

- 1) “**Adjusted P/E Multiple**” has the meaning given in Article 21.4;
- 2) “**Affiliate**” means, (i) in respect of any specified Person, any other Person directly or indirectly Controlling or Controlled by or under direct or indirect common Control with such specified Person, and (ii) in respect of the Investor, without prejudice to the foregoing any fund, collective investment scheme, trust, partnership (including any co-investment partnership) or investment company / special purpose vehicle / investment fund owned, managed, advised or Controlled by (a) the Investor or by its Affiliates, or (b) the investment manager or investment advisor of the Investor and/ or its Affiliates; provided that no Group Company shall be considered an Affiliate of any Shareholder. In case of natural persons, his/her Relatives shall also be deemed to be Affiliates of such natural persons;
- 3) “**Period**” has the meaning given in Article 21.6;
- 4) “**Anti-Corruption Laws**” has the meaning given in Schedule 4 (*Regulatory Requirements*);
- 5) “**Anti-Money Laundering Laws**” means those laws, regulations and sanctions that (a) limit the use of and/or seek the forfeiture of proceeds from illegal transactions; (b) limit commercial transactions with designated countries or individuals believed to be terrorists, narcotics dealers, supporters of weapons proliferation or otherwise engaged in activities contrary to the interests of the United States or other applicable countries; (c) may require the Investor to obtain information on the identity of, and source of funds for investment by, the Sponsors; or (d) are designed to disrupt the flow of funds to terrorist organisations;
- 6) “**Annual Business Plan and Budget**” means (i) the annual operating and capital budget for the Group Companies for a Financial Year, and (ii) the annual business and financing plan for the business of the Group Companies for a Financial Year, which plan shall include details of the business of the Group Companies for a Financial Year, which plan shall include details of projected revenues, operating and capital expenditure, cash flow and financing requirements and the amount, timing and means of any external and/or Shareholder financing (if any), and which shall become effective upon approval pursuant to Article 41.2;
- 7) “**Articles**” or “**Articles of Association**” means the articles of association of the Company, from time to time;
- 8) “**Authorisation**” means any (a) authorisation, consent, approval, resolution, license, permit, exemption, filing, notarisation, lodgement, registration or waiver of notice of a Governmental Authority or any Third Party; and (b) authorisation, resolution or approval of the board and/or shareholders of a Group Company;
- 9) “**Audited PAT**” means the consolidated profit after tax of the Group Companies for the relevant Financial Year, per the audited financial statements of the Company;
- 10) “**Big 4 Accounting Firms**” means Ernst & Young, KPMG International, Deloitte & Touche, and PWC and/or their respective associated firms in India;
- 11) “**Board**” or “**Board of Directors**” means the board of directors of the Company, from time to time;
- 12) “**Books and Records**” has the meaning ascribed to it in the Share Subscription and Purchase Agreement;
- 13) “**Business**” has the meaning given in Article 42.1;
- 14) “**Business Day**” means any day which is not a Saturday or Sunday or a public holiday in Mumbai, India and Singapore, on which banks are generally open for inter-bank transactions in the aforementioned jurisdictions;
- 15) “**CCPS**” means 291,083 (Two hundred ninety one thousand and eighty three) compulsorily convertible preference shares of the Company, each having a face value of INR 10 (Indian Rupees Ten) and a premium of INR 1,691.92 (Indian Rupees One thousand six hundred ninety one and ninety two Paise), and having the rights set out in Schedule 1 (*Terms and Conditions of the Investor Shares*);



- 16) “**CCPS Consideration**” means an amount of INR 495,399,979 (Indian Rupees Four hundred and ninety-five million three hundred ninety nine thousand nine hundred and seventy nine), payable by the Investor to the Company for the CCPS;
- 17) “**Chairman**” means the chairman of the Board, from time to time;
- 18) “**Change of Control**” shall occur if a Person who has Control of a body corporate ceases to do so;
- 19) “**Companies Act**” means the Companies Act, 2013 as amended from time to time and shall include any statutory replacement or re-enactment thereof;
- 20) “**Completion Date**” has the meaning ascribed to it in the Share Subscription and Purchase Agreement;
- 21) “**Compliance Code**” has the meaning given in paragraph 4.3 of Schedule 4 (*Regulatory Requirements*);
- 22) “**Consideration**” has the meaning ascribed to it in the Share Subscription and Purchase Agreement;
- 23) “**Confidential Information**” has the meaning given in Article 49;
- 24) “**Control**” or “**control**” means, in relation to a Person:
  - i. holding or controlling, directly or indirectly, a majority of the voting rights exercisable at shareholder meetings (or the equivalent) of that Person; or
  - ii. having, directly or indirectly, the right to appoint or remove directors holding a majority of the voting rights exercisable at meetings of the board of directors (or the equivalent) of that Person; or
  - iii. having directly or indirectly the ability to direct or procure the direction of the management and policies of that Person, whether through the ownership of shares, by contract or otherwise; and
  - iv. the terms “**controlling**” and “**controlled**” shall be construed accordingly;
- 25) “**Conversion**” has the meaning given in Schedule 1 (*Terms and Conditions of the Investor Shares*);
- 26) “**Conversion Date**” has the meaning given in Schedule 1 (*Terms and Conditions of the Investor Shares*);
- 27) “**Conversion Notice**” has the meaning given in Schedule 1 (*Terms and Conditions of the Investor Shares*);
- 28) “**Conversion Period**” has the meaning given in Schedule 1 (*Terms and Conditions of the Investor Shares*);
- 29) “**Conversion Shares**” has the meaning given in Schedule 1 (*Terms and Conditions of the Investor Shares*);
- 30) “**Corporate Action Event**” has the meaning given in Schedule 1 (*Terms and Conditions of the Investor Shares*);
- 31) “**Deed of Adherence**” means a deed substantially in the form set out in Schedule 2 (*Deed of Adherence*);
- 32) “**Default Notice**” has the meaning given in Article 26.2;
- 33) “**Default Sale Price**” has the meaning given in Article 26.3.1;
- 34) “**Default Sale Shares**” has the meaning given in Article 26.3.2;
- 35) “**Depository**” means and includes a Company as defined in the Depositories Act 1996;
- 36) “**Director**” means a member of the Board of Directors, from time to time, and “**Directors**” shall be

construed accordingly;

- 37) “**Distribution Agreement**” has the meaning ascribed to it in the Share Subscription and Share Purchase Agreement;
- 38) “**Divestment Ruling**” has the meaning given in Article 74;
- 39) “**Dispute**” has the meaning given in Article 61.1;
- 40) “**Distribution**” means any dividend, buy-back, redemption or any other distribution of assets by the Company to any Shareholder;
- 41) “**Effective Date**” means the Completion Date;
- 42) “**Encumbrance**” means any pledge, charge, lien, mortgage, debenture, hypothecation, security interest, pre-emption right, option or any other defect in title, encumbrance or third party right or claim of any kind or any agreement to create any of the above;
- 43) “**EoD Seller**” has the meaning given in Article 26.3.2;
- 44) “**Equity Shares**” means the ordinary equity shares of the Company having a face value of INR 10 (Indian Rupees Ten) each;
- 45) “**Event of Default**” means any event or circumstance specified as such in Article 26.1;
- 46) “**Exempted Transfer**” has the meaning given in Article 10.7;
- 47) “**Exercise Notice**” has the meaning given in Article 21.2;
- 48) “**Existing Shareholders**” means any of the Sponsors;
- 49) “**Exit Purchase**” has the meaning given in Article 16.1;
- 50) “**Failed IPO**” has the meaning given in Article 20.3;
- 51) “**FCPA**” means the U.S. Foreign Corrupt Practices Act, 15 U.S.C. sections 78dd-1, et seq.;
- 52) “**Financial Year**” means the period from 1 April of a calendar year to 31 March of the following calendar year;
- 53) “**First Right**” has the meaning given in Article 12.1;
- 54) “**FMV**” has the meaning given in Article 21.2;
- 55) “**Foreign Investment**” shall have the meaning given to it in the consolidated foreign direct investment policy effective from 17 April 2014, issued by the Department of Industrial Policy and Promotion, Ministry of Commerce and Industry, and as amended from time to time;
- 56) “**Governmental Authority**” has the meaning ascribed to it in the Share Subscription and Purchase Agreement;
- 57) “**Government Official**” means any officer or employee of a Governmental Authority or any department, agency, or instrumentality thereof, or of a public international organisation, or any person acting in an official capacity for or on behalf of any such Governmental Authority or department, agency, or instrumentality, or for or on behalf of any such public international organisation, or any political party, party official or candidate thereof;
- 58) “**Group Companies**” or “**Group**” has the meaning ascribed to it in the Share Subscription and Purchase Agreement;

- 59) “**Investor**” means TPG GROWTH II SF PTE. LTD, a company incorporated in Singapore whose registered office is at 80 Raffles Place, #15-01 UOB Plaza, Singapore 048624;
- 60) “**Investor Director**” has the meaning given in Article 32.1;
- 61) “**Investor Equity Shares**” has the meaning given in Article 25.2;
- 62) “**Investor Event of Default**” has the meaning given in Article 26.3.3;
- 63) “**Investor Free Transfer**” has the meaning given in Article 10.13;
- 64) “**Indemnified Parties**” has the meaning given in Article 48.1;
- 65) “**Indemnifying Party**” has the meaning given in Article 48.1;
- 66) “**Indemnity Amount**” has the meaning given in Article 48.5;
- 67) “**Intellectual Property**” has the meaning ascribed to it in the Share Subscription and Purchase Agreement;
- 68) “**Investor Partner**” has the meaning given in Article 10.5;
- 69) “**INR**” or “**Rupees**” means the lawful currency of the Republic of India;
- 70) “**IPO**” or “**Initial Public Offering**” means the first public offering of Shares (which public offering complies with all applicable legal, regulatory and listing requirement) whether by means of a fresh issue of additional Shares, an offer of Shares by the Shareholders or a combination of the foregoing, and the listing of such Shares and their admission to trading on a Recognised Stock Exchange;
- 71) “**Insolvency Event**” means any of the following events:
- i. the relevant party (i) is unable to pay its debts as they fall due and payable, and such debts are not paid within 180 (one hundred and eighty) days of the date on which they become due and payable, or (ii) admits inability to pay its debts as they fall due and payable or, by reason of financial difficulties reschedules its indebtedness;
  - ii. the relevant party voluntarily files or institutes a petition or proceeding seeking a judgment of insolvency or an order for winding up or any other relief under any bankruptcy or insolvency laws or other laws affecting creditor rights;
  - iii. any Person (i) files or institutes against the relevant party, a petition or proceeding seeking a judgment of insolvency or an order for winding up or any other relief under any bankruptcy or insolvency laws or other laws affecting creditor rights on account of a failure by the relevant party to pay an amount, when due and payable, and any such petition or proceeding is not dismissed within 180 (one hundred and eighty) days, and such person obtains an admission order or interlocutory order in connection with such petition or proceeding (including for the appointment of a provisional liquidator, receiver or manager in respect of the relevant party or any of its assets), and provided that if any such order is an ex parte order passed by a court, such order is not stayed or dismissed within a period of 30 (thirty) days, or (ii) obtains a judgment of insolvency or a winding up order in respect of the relevant party from a court of competent jurisdiction and such judgment of insolvency or winding up order is not stayed or dismissed within a period of 60 (sixty) days;
  - iv. any corporate action, legal proceedings or other procedure or step is taken or notice is given in relation to a composition or arrangement with any creditors of the relevant party (in respect of relief in respect of debt repayment obligations);
  - v. any legal proceedings are initiated in connection with the enforcement of any security over any assets of the relevant party, provided that, such legal proceedings are not dismissed within a period of 180 (one hundred and eighty) days; or

- vi. any analogous procedure or step is taken in any jurisdiction with respect to the relevant party;
- 72) “**Loss**” or “**Losses**” means any and all losses, liabilities, actions and claims including charges, costs, damages, fines, penalties, interest and reasonable legal and other professional fees and expenses including, without limitation in each case, all related Taxes. For the avoidance of doubt, Losses shall (i) include any loss of goodwill only for the purposes of breach of Articles 42 to 44 of these Articles; and (ii) exclude any losses which are of remote, punitive and exemplary nature;
- 73) “**Kolkata Shareholders Agreement**” means the Share Subscription and Shareholders Agreement (dated 14 February 2014) between the Company, LCEPL, Sponsor 1, Sponsor 2 and Autocity Services Private Limited;
- 74) “**LCEPL**” means Landmark Cars (East) Private Limited, a company incorporated in India under the (Indian) Companies Act, 1956, whose registered office is at 3rd Floor, Landmark House, Opp. AEC, Near Gurudwara, Thaltej Cross Road, S. G. Highway, Ahmedabad, Gujarat – 380059;
- 75) “**Liquidation Preference Amount**” has the meaning given in Schedule 1 (*Terms and Conditions of the Investor Shares*);
- 76) “**Lowest Permissible Price**” has the meaning given in Schedule 1 (*Terms and Conditions of the Investor Shares*);
- 77) “**Memorandum**” or “**Memorandum of Association**” means the memorandum of association of the Company, from time to time;
- 78) “**Merchant Bank**” has the meaning given in Article 18.1(ii);
- 79) “**New Business**” has the meaning given in Article 44.3.1;
- 80) “**New Issuance**” has the meaning given in Article 14.1;
- 81) “**Non-Executive Directors**” has the meaning ascribed in Article 37.2;
- 82) “**Non-Transferring Party**” has the meaning given in Article 12.1;
- 83) “**Notice**” has the meaning given in Clause 70.1;
- 84) “**OFAC**” means the U.S. Department of Treasury’s Office of Foreign Assets Control;
- 85) “**Offer Notice**” has the meaning given in Article 12.2;
- 86) “**Offer Price**” has the meaning given in Article 12.2;
- 87) “**Offered Shares**” has the meaning given in Article 12.2;
- 88) “**Parties**” shall mean the Investor, the Shareholders and the Company;
- 89) “**Person**” means a corporation, association, unincorporated association, partnership (general or limited), joint venture, estate, trust, limited liability company, limited liability partnership or any other legal entity, individual or government, state or agency of a state;
- 90) “**Prohibited Actions**” has the meaning given in Schedule 4 (Regulatory Requirements);
- 91) “**Prospective Purchaser**” has the meaning given in Article 12.2;
- 92) “**Put Option**” has the meaning given in Article 21.1;
- 93) “**Put Option Purchase Price**” has the meaning given in Article 21.2;
- 94) “**Put Option Securities**” has the meaning given in Article 21.1;

- 95) “**QIPO**” or “**Qualified Initial Public Offering**” means an IPO, pursuant to which Shares constituting (i) a minimum of 30% (thirty percent) of the share capital of the Company (on a fully diluted basis) are listed on a Recognized Stock Exchange; and (ii) at least 75% (seventy five percent) of the Shares then held by the Investor are offered by the Investor as part of the offer for sale component of the IPO;
- 96) “**Quarter**” means a 3 (three) month period each commencing on 1 January, 1 April, 1 July and 1 October of each calendar year;
- 97) “**Recipient**” has the meaning given in Article 49;
- 98) “**Recognized Stock Exchange**” means the Bombay Stock Exchange Limited or the National Stock Exchange of India Limited or any other internationally recognised public securities market acceptable to the Investor;
- 99) “**Related Party**” means (i) any shareholder holding 5% (five percent) or more of the paid up equity share capital of any of the Group Companies; (ii) any director of such Group Company; (iii) any officer (as defined in the Companies Act) of such Group Company; (iv) any Relative of a shareholder, director or officer (as defined in the Companies Act) of such Group Company; (v) any Person in which any aforesaid shareholder, director or officer (as defined in the Companies Act) of such Group Company has any economic interest, other than a passive shareholding of less than 5% (five percent) in a publicly listed company; (vi) any other Affiliate of such Group Company or of a shareholder or of a director or officer of such Group Company; and/or (vii) a related party within the meaning of Indian GAAP. For the purposes of these Articles it is clarified that each of the Sponsors and their Affiliates shall be deemed to be a Related Party of the Group Companies;
- 100) “**Related Party Transaction**” has the meaning given in paragraph 8.1(a) of Schedule 3 (*Company Covenants*);
- 101) “**Relative**” means, in respect of any natural person, his or her spouse, parents and children;
- 102) “**Relevant Proportion**” means, in the case of each Shareholder, such percentage as equates to the total number of Shares (on a fully diluted basis) held by such Shareholder as a percentage of the total number of Shares then issued and outstanding on a fully diluted basis save that if the expression “Relevant Proportion” is used in the context of some (but not all) of the Shareholders, it shall mean such percentage as equates to the total number of Shares held by such Shareholder (on a fully diluted basis) as a percentage of the total number of Shares held by the Shareholders to whom the context refers on a fully diluted basis (“**Relevant Shareholder**”). For the avoidance of doubt, it is clarified that (i) in the event of exercise of a Tag Along Right in accordance with Article 13, the Relevant Shareholder shall be the Transferring Party; and (ii) in calculating the total number of Shares held by the Investor for the purposes of determining its Relevant Proportion, the provisions of Schedule 1 (*Terms and Conditions of the Investor Shares*) shall apply (in the event the Investor is holding any CCPS);
- 103) “**Representative**” has the meaning given in Article 71.1;
- 104) “**Reserved Matters**” has the meaning given in Article 41.2;
- 105) “**Restricted Activities**” means with respect to the Sponsors or any of their Affiliates:
- i. establishing another entity, vehicle or joint venture or entering into any business that, in each case, is competitive with, or potentially competitive with, or has the same or substantively the same goals and objectives as, the Business;
  - ii. either solely or jointly with or on behalf of any Person directly or indirectly carrying on, or being engaged in, or employed by, or receiving any financial benefit from, or interested in any business or entity which is competitive with, or potentially competitive with, or carries on or is proposed to carry on a business with the same or substantively the same goals and objectives, as the Business;
  - iii. provides any know-how or technical assistance to any Person, other than the Group Companies, in relation to the Business;

- iv. soliciting, canvassing, enticing away or inducing or persuading or attempting in any manner to solicit, canvass, entice away, induce or persuade any Person dealing or engaged with the Group Companies, to (i) cease dealing or doing business or to (ii) reduce the amount of dealings or business which any such Person has customarily done with the Group Companies or to (iii) unfavourably vary the terms of their business or dealings with the Group Companies; (iv) discontinue the affiliation or relationship (existing or proposed arrangement) of a community or institution with the Group Companies; and (v) to refer prospective clients/customers/supplier to any competitor of the Group Companies or to discontinue referring prospective clients/customers/supplier to the Group Companies;
  - v. negotiating with any Person for the purposes identified in (a), (b), (c) and (d) above;
  - vi. offering employment to, entering into a contract for the services of, or attempting to entice away from any of the Group Companies, any individual who is (at the time of the offer or attempt), or has been at any time within the 12 (twelve) month period prior to the offer or attempt, an employee of a Group Company, or procuring or facilitating the making of any such offer or attempt by any other Person, or interfering in any manner with the contractual, employment or other relationship of the employee of the Group Companies and/or any of its Affiliates; or
  - vii. causing or permitting any Person directly or indirectly under its control to do any of the foregoing acts or things;
- 106) “**Restricted Period**” means, in relation to the Sponsors, the period from and including the Effective Date until the date of termination of the Shareholders Agreement; provided that, if, during the period in which the Investor continues to hold any Shares, any of the Sponsors and their Affiliates cease to be Shareholders, the term “**Restricted Period**” shall include such additional period during which the Investor and/or its Affiliates continue to hold any Shares, subject to a maximum of 2 (two) years from the date on which each of the Sponsors and their Affiliates cease to be Shareholders;
- 107) “**ROFR Acceptance Notice**” has the meaning given in Article 12.3;
- 108) “**ROFR Period**” has the meaning given in Article 12.3;
- 109) “**Rules**” has the meaning given in Article 61.2;
- 110) “**Sanctions Laws and Regulations**” means any law, rules, regulations, sanctions or measures promulgated, imposed, administered or enforced by the Office of Foreign Assets Control of the U.S. Department of Treasury (including but not limited to U.S. Comprehensive Iran Sanctions, Accountability, and Divestment Act of 2010 and the implementing regulations), Her Majesty’s Treasury, the European Union, the United Nations or any other relevant sanctions authority, more details in relation to which can be located at:
- i. <http://www.treasury.gov/resource-center/sanctions/Programs/Pages/Programs.aspx>
  - ii. <https://www.treasury.gov/ofac/downloads/t11sdn.pdf>
  - iii. <http://www.hm-treasury.gov.uk/d/sanctionsconlist.pdf>.
  - iv. [http://ec.europa.eu/external\\_relations/cfsp/sanctions/consol-list\\_en.htm](http://ec.europa.eu/external_relations/cfsp/sanctions/consol-list_en.htm)
  - v. <http://www.un.org/sc/committees/>
  - vi. <http://www.treasury.gov/resource-center/sanctions/Programs/Pages/Programs.aspx>;
- 111) “**Sanctions Target**” means
- i. any Person on any list of restricted individuals, entities and/or organizations published by the Office of Foreign Assets Control of the U.S. Treasury Department, Her Majesty’s Treasury, the European Union, the United Nations, more details in relation to which can be identified at:
    - <https://www.treasury.gov/ofac/downloads/t11sdn.pdf>;
    - <http://www.hm-treasury.gov.uk/d/sanctionsconlist.pdf>;
    - [http://ec.europa.eu/external\\_relations/cfsp/sanctions/consol-list\\_en.htm](http://ec.europa.eu/external_relations/cfsp/sanctions/consol-list_en.htm) and;
    - <http://www.un.org/sc/committees/>; and

- ii. any other Person that, because of its, his or her location, residency, domicile, nationality, place of incorporation, ownership or activities, is targeted under or the subject of any of the Anti-Money Laundering Laws and Sanctions Laws and Regulations;
- 112) “**Sale Shares**” has the meaning given in the Share Subscription and Purchase Agreement;
  - 113) “**Shareholder**” means any Person registered in the books of the Company as the holder of a Share for the time being;
  - 114) “**Shares**” means the Equity Shares and the CCPS issued by the Company and any other securities (including those convertibles into or exercisable or exchangeable for Equity Shares) issued by the Company, and “**Share**” shall be construed accordingly;
  - 115) “**Share Subscription and Purchase Agreement**” means the Share Subscription and Purchase Agreement dated 4 November 2014 entered into among the Investor, the Sponsors and the Company for the purposes of (i) the subscription to the CCPS by the Investor; and (ii) the purchase of Sale Shares by the Investor;
  - 116) “**Shareholders Agreement**” means the shareholders agreement dated 4 November 2014 entered into amongst the Investor, the Sponsors and the Company;
  - 117) “**Sponsor 1**” shall mean Mr. Sanjay Karsandas Thakker;
  - 118) “**Sponsor 2**” shall mean Mrs. Ami Sanjay Thakker;
  - 119) “**Sponsors**” shall mean collectively, Sponsor 1 and Sponsor 2;
  - 120) “**Sponsor Controlled Entity**” has the meaning given in Article 10.7.1;
  - 121) “**Sponsor Decision Notice**” has the meaning given in Article 21.6;
  - 122) “**Sponsor Director**” has the meaning given in Article 32.1;
  - 123) “**Sponsor HUF**” has the meaning given in Article 10.7.3;
  - 124) “**Subsidiary**” has the meaning given in the Companies Act;
  - 125) “**Tag Along Notice**” has the meaning given in Article 13.1;
  - 126) “**Tag Along Shares**” has the meaning given in Article 13.1;
  - 127) “**Tax**” or “**Taxation**” has the meaning ascribed to it in the Share Subscription and Purchase Agreement;
  - 128) “**Third Party**” means any Person other than the Shareholders, their Affiliates and the Group Companies;
  - 129) “**Transaction Documents**” means these Articles, the Shareholders Agreement, the Share Subscription and Purchase Agreement and all deeds, documents, letters, exhibits, schedules and annexures designated as such by the Parties;
  - 130) “**Transactional Requirements**” has the meaning given in paragraph 4.1 of Schedule 4 (*Regulatory Requirements*);
  - 131) “**Transfer**” means to transfer, sell, convey, assign, pledge, hypothecate, create a security interest in or Encumbrance on, place in trust (voting or otherwise), transfer by operation of law or in any other way subject to any encumbrance or dispose of, whether or not voluntarily, and “**Transferring**” and “**Transferred**” have corresponding meanings;

- 132) “**Transferring Party**” has the meaning given in Article 12.1;
- 133) “**Valuer**” has the meaning given in Article 21.3;
- 134) “**Valuer Banks**” means any of (i) Goldman Sachs; (ii) Morgan Stanley; (iii) JP Morgan; (iv) Credit Suisse; (v) UBS; and (vi) Citibank, or their respective successors at the relevant time;
- 135) “**Valuation Notice**” has the meaning given in Article 21.5;
- 136) “**Warrantors**” means each of the Sponsors and the Company; and
- 137) “**Winding Up**” means the winding-up, dissolution, liquidation, or any other analogous procedure or step of the Company.

## **2.1. Interpretation**

In these Articles, unless the context otherwise requires:

- 2.1.1. The expression “**in the agreed terms**” or “**agreed form**” means in the form agreed among the Parties and signed for the purposes of identification by or on behalf of each of the Parties.
- 2.1.2. References to “**include**” or “**including**” are to be construed without limitation.
- 2.1.3. The expression “**ordinary course of business**” shall have the meaning given in the Share Subscription and Purchase Agreement;
- 2.1.4. References to a “**company**” include any company, corporation or other body corporate wherever and however incorporated or established.
- 2.1.5. The expression “**body corporate**” shall have the meaning given in the Companies Act.
- 2.1.6. A Party or any other Person includes its successors in title, permitted assigns and permitted transferees.
- 2.1.7. The table of contents and headings are inserted for convenience only and shall not affect the construction or interpretation of these Articles.
- 2.1.8. Words in the singular include the plural and vice versa, and a reference to any gender includes all other genders.
- 2.1.9. References to Articles, Recitals, Clauses, Appendices, Annexures, Paragraphs, Preamble and Schedules are to recitals, appendices and annexures to, and articles, clauses, paragraphs, preamble and schedules of these Articles, all of which form part of these Articles.
- 2.1.10. References to any statute or statutory provision include a reference to that statute or statutory provision as amended, consolidated or replaced from time to time (whether before or after the date of these Articles and / or the Shareholders Agreement as the case may be) and include any subordinate legislation made under the relevant statute or statutory provision.
- 2.1.11. References to Shares held by the Investor, includes a reference to the aggregate of all Shares then held by (i) the Investor; and (ii) each of the Affiliates of the Investor.
- 2.1.12. In calculations of the number of Shares, (i) references to a “**fully diluted basis**” mean that the calculation should be made assuming that all outstanding options, warrants, preference shares and other securities convertible into or exercisable or exchangeable for Equity Shares (whether or not by their term then currently convertible, exercisable or exchangeable), have been so converted, exercised or exchanged, and (ii) references to a “**non-diluted basis**” mean that the calculation should be made taking into account only Equity Shares then in issue.
- 2.1.13. Any payments to be made by a Party pursuant to the provisions of the Shareholders Agreement to any other Party, must be in immediately available cleared funds.



2.1.14. All approvals and/or consents to be granted by the Parties under these Articles shall be deemed to mean approvals and/or consents in writing.

2.1.15. The terms “**hereof**”, “**herein**”, “**hereby**” and derivative or similar words refer to these Articles and not to any particular clause, article or section of these Articles.

2.1.16 Time is of the essence in the performance of the Parties’ respective obligations; if any time period specified herein is extended, such extended time shall also be of the essence.

### **3. PUBLIC COMPANY<sup>2</sup>**

The Company is a public company within the meaning of Section 2(71) of the Companies Act and:

- a) The minimum paid up capital of the Company shall be Rupees 5 (five) lakhs, or such higher amount as may be prescribed under the Act, as amended or notified from time to time;
- b) The rights to transfer the Shares in the Company are not restricted in the manner and are freely transferable.

### **4. SHARE CAPITAL**

The authorized share capital of the Company shall be such as is set out in Article V of the Memorandum of Association of the Company from time to time, with power to increase, reduce or modify the said capital and to divide the share capital for the time being of the Company into several classes and attach thereto preferential, deferred, qualified or special rights or conditions, as may be determined by or in accordance with the Articles of Association of the Company and subject to applicable laws, and to vary, modify or abrogate any such rights, privileges or conditions in such manner as may for the time being be provided for by the Articles of Association of the Company and subject to applicable laws as may be agreed by the Shareholders, subject to resolution being passed approving the same as a Reserved Matters is in accordance with the provisions of these Articles of Association.

### **5. INCREASE AND REDUCTION OF CAPITAL AND FURTHER FUNDING**

The Company shall have power, subject to and in accordance with the provisions of Sections 68,69,70 and Section 66 of the Companies Act and the relevant rules and regulations, as may be prescribed in this regard from time to time, to purchase any of its Shares or to reduce its share capital in any manner whatsoever, or such of its other specified securities as may be permitted from time to time on such terms and conditions and in such manner as may be prescribed by applicable law from time to time.

5A.<sup>3</sup> Subject to the provisions of section 14 and other applicable provisions, if any, of the Act and subject to the Articles of Association, the Board may, from time to time, create, offer and issue to or for the benefit of the Company's permanent employees who are working in India or outside India and Directors whether whole-time or otherwise, of the Company (other than the promoters of the Company belonging to the promoter group, Independent Directors and Directors holding directly or indirectly more than 10% of the outstanding equity shares of the Company) such number of equity shares of the Company of the face value of Rs. 10/- each not exceeding in number at any time in the aggregate 12 % of the issued capital, for subscription on such terms and conditions as may be determined by the Board prior to the issue and offer, in consultation with the authorities concerned and in accordance with such guidelines or other provisions of law as may be prevalent at that time but ranking pari passu with the existing equity shares of the Company:

- a. The issue price of such shares shall be determined by the Board in accordance with the laws prevalent at the time of the issue.
- b. In the alternative to equity shares, mentioned hereinabove, the Board may also issue equity warrants or other securities, as may be permitted in law, from time to time.
- c. All such issues as above are to be made in pursuance of Employees' Stock Option (ESOP) Scheme to be drawn up and approved by the Board.

---

<sup>2</sup> Article 3 has been replaced by passing special resolution at an Extra-Ordinary General of Members held on 10<sup>th</sup> November, 2021.

<sup>3</sup> Article 5A has been inserted by Members of the Company by passing a special resolution at an Extra Ordinary General Meeting No.1/18-19 held on 6<sup>th</sup> April, 2018

## **5B.4 CONSOLIDATION, MERGER, DEMERGER OR AMALGAMATION**

Subject to the provisions of the Act, Rules and Article 41.2 (Affirmative Rights of the Investor), the Company shall have the power to undertake a consolidation, merger, demerger or amalgamation with any other company or body corporate;

## **6. VARIATION OF RIGHTS**

The rights conferred upon the holders of the Shares of any class issued with preferred or other right shall not, unless issued in accordance with these Articles of Association and subject to compliance of the Reserved Matter and otherwise expressly provided by the terms of issue of the Shares of that class, be deemed to be varied by the creation or issue of further Shares ranking pari passu therewith.

## **7. NO TRUST UPON SHARES**

Except as required by applicable Law, no person shall be recognised by the Company as holding any Shares upon any trust, and the Company shall not be bound by, or be compelled in any way to recognise (even when having notice thereof) any equitable, contingent, future or partial interest in any Share, or any interest in any fractional part of a Share, or (except only as by these regulations or by applicable Law otherwise provided) any other rights in respect of any Share except an absolute right to the entirety thereof in the registered holder.

## **8. SHARE CERTIFICATES**

8.1 Every person whose name is entered as a Member in the Register of Members shall be entitled to receive within two months after allotment or within one month after the application for the registration of transfer (or within such other period as the conditions of issue shall provide):

- (a) one certificate for all his Shares without payment; or
- (b) several certificates, each for one or more of his Shares, upon payment of twenty rupees for each certificate after the first.

8.2 Every certificate shall be under the Seal and shall specify the Shares to which it relates and the amount paid-up thereon.

8.3 If a Share certificate is defaced, lost or destroyed, it may be renewed on payment of such fee, if any, not exceeding two rupees, and on such terms, if any, as to evidence and indemnity and the payment of out-of-pocket expenses incurred by the Company in investigating evidence, as the Directors think fit.

8.4 Every holder of or Shares of the Company shall have the option to receive Share certificates or to hold the Shares with a depository. Such a person who is the beneficial owner of the Shares can at any time opt out of a Depository, if permitted, by the law, in respect of any security in the manner provided by the Depositories Act, 1996 and the Company shall, in the manner and within the time prescribed, issue to the beneficial owner the required certificates for the Shares.

8.5 If any Share stands in the names of 2 (two) or more persons, the Person first named in the register of Members of the Company shall as regards voting at meetings of the Company, service of notice and all or any matters connected with the Company, except the transfer of Shares and any other matters herein otherwise provided, be deemed to be sole holder thereof but joint holders of the Shares shall be severally as well as jointly liable for the payment of all deposits, instalments and calls due in respect of such Shares and for all incidents thereof according to the Company's Articles.

## **9. PREFERENCE SHARES**

9.1 Subject to provision of this Articles, the Company may issue all kinds of preference shares such as cumulative preference shares, non-cumulative preference shares, convertible preference shares, non-convertible preference shares, participating preference shares, non-participating preference shares, redeemable preference shares, irredeemable preference shares, or are liable to be redeemed at the option of the Company or the holder, and

---

<sup>4</sup> Article 5B has been inserted by Members of the Company by passing a special resolution at an 12th Annual General Meeting held on 26th September 2018

the directors of the Company may determine the terms, conditions and manner of redemption of any such shares.

- 9.2 Each CCPS shall have such rights as set forth in Schedule 1 (*Terms and Conditions of the Investor Shares*) hereto. The conversion of the CCPS shall be in accordance with the terms set out in Schedule 1 (*Terms and Conditions of the Investor Shares*) hereto.

## **9A Covenants**

- 9A.1 The Group Companies shall, and the Sponsors shall cause the Group Companies to:

9A.1.1 comply with all material applicable laws to which each may be subject; and

9A.1.2 comply with the covenants set out in this Article 9A and in Schedule 3 (*Company Covenants*).

- 9A.2 The Group Companies shall, and the Sponsors shall cause the Group Companies to obtain promptly, comply with and do all that is necessary to maintain in full force and effect, and, upon request, supply certified copies to the Investor of any Authorisation required to:

9A.2.1 ensure the legality, validity, enforceability or admissibility in evidence in any relevant jurisdiction of the Transaction Documents; and

9A.2.2 carry on its Business.

- 9A.3 The Company and the Sponsors undertake that (a) they shall not enter into, and shall procure that neither any Group Company nor the Shareholders enter into, any agreements / arrangements (whether written or oral or whether moral, tacit or otherwise) with the other Shareholders of the Company in connection with any matter linked with investments in and/or exits from the Company, unless the prior written approval of the Investor has been specifically obtained, and (b) they shall on an on-going basis, disclose any and all agreements and/or arrangements (whether written or oral or whether moral, tacit or otherwise), entered into with any Shareholder. For the avoidance of doubt, this Article 9A.3 does not restrict the ability of the Sponsors to undertake an Exempted Transfer.

- 9A.4 During the subsistence of the Shareholders Agreement and/ or these Articles, the Company and the Sponsors hereby jointly and severally covenant (and undertake to procure for the benefit of the Investor) as provided in Schedule 4 (*Regulatory Requirements*).

- 9A.5 Each of the Sponsors undertakes to the Investor that each of their obligations under the Shareholders Agreement and/ or these Articles shall be joint and several.

- 9A.6 To the extent applicable, the Parties undertake to act in accordance with the terms of the Distribution Agreement.

- 9A.7 unless otherwise agreed by the Investor and Sponsor 1, the CCPS Consideration received from the Investor shall be utilized solely for the working capital and growth requirements of the Group Companies (in each case, based on the Annual Business Plan and Budget mutually agreed between the Sponsors and the Investor).

## **10. TRANSFER AND ADDITIONAL ISSUANCE OF SHARES**

### *TRANSFERS BY THE SHAREHOLDERS; GENERAL RESTRICTIONS*

- 10.1 **Deed of Adherence:** If a Shareholder wishes to Transfer any Shares (which Transfer shall also be subject to the other applicable provisions of the Shareholders Agreement and/ or these Articles, including Article 10.6), it shall, as a condition of the Transfer, cause the transferee to execute a Deed of Adherence confirming that the transferee shall be bound by the Shareholders Agreement and the other Transaction Documents to the same extent as the transferring Shareholder in respect of the Shares transferred to that transferee. If such transferee is a Relative and is a minor or a trust or otherwise lacks legal capacity to enter into agreements under applicable law, the transferring Shareholder shall, as a condition of the Transfer, procure that the Deed of Adherence is executed in compliance with applicable law (including any requirement that the Deed of Adherence be executed by a minor transferee's parents or court-appointed guardian, or by the trustee in case of a trust) such that the Deed of

Adherence and the Transaction Documents will constitute valid and binding obligations of such transferee, enforceable against such transferee in accordance with their terms.

- 10.2 **Nullification of Contravening Share Transfers:** Any attempted Transfer made by any Shareholder in violation of the Shareholders Agreement and/ or these Articles shall be null and void *ab initio*. Neither the Board nor the Shareholders shall approve or ratify any Transfer made in contravention of the restrictions contained in Articles 10 to 15 or elsewhere in the Shareholders Agreement and/ or these Articles, and the Company shall (i) not record any such erroneous Transfer on the statutory registers of the Company maintained for the Shares, (ii) reject and reverse such erroneous Transfer made or attempted without necessity of a Board decision. Subject to the foregoing, the Company shall not have the power to refuse registration of a Transfer which is in compliance with the provisions of the Shareholders Agreement and/ or these Articles.
- 10.3 **Share Transfers in Group Companies (other than the Company):** Subject to an Exempted Transfer, the Company and the Sponsors shall not, and shall procure that none of the shareholders of the other Group Companies, Transfer any share of such Group Companies without the prior written consent of the Investor. For the avoidance of doubt, (i) the provisions of Articles 10.1 and 10.2 apply *mutatis mutandis* with respect to Transfer of shares of the Group Companies; and (ii) the provisions of this Article 10.3 do not apply to Autocity Services Private Limited.
- 10.4 **Notification of Transfers by the Company:** Within 30 (thirty) days of registering any Transfer of Shares / shares in its appropriate registers / records of the Group Companies, the Company shall send a notice to each Shareholder stating that such Transfer has been completed and setting forth the name of the transferor, the name of the transferee and the number of Shares / shares Transferred.
- 10.5 **Distributions to the Investor Partner:** Notwithstanding any other provisions of the Shareholders Agreement and/ or these Articles, the requirements under Articles 10.1 to 10.5, 10.12 and 12 shall not apply to any Transfer by the Investor of any of its Shares to any member, general partner or limited partner of the Investor and/or its Affiliates (each, an “**Investor Partner**”) pursuant to a distribution that is made pro rata to such Investor Partner in accordance with its rights under the relevant partnership or limited liability company agreement, and without payment of additional consideration thereof by the Investor, and any such transferees shall not be bound by the provisions of the Shareholders Agreement and/ or these Articles and/or required to enter into a Deed of Adherence. For the avoidance of doubt, any distribution of Shares pursuant to this Article 10.5 will be subject to the provisions of Article 9A.6; and (ii) in the event of the foregoing distribution to the Investor Partner, the rights and the obligations of the Investor under the Shareholders Agreement and/ or these Articles shall be available to the Investor Partner (s) only if they all act collectively and exercise their rights as a single block of Shares and the Sponsors and / or the Company shall recognize only one such Investor Partner, nominated by all the Investor Partners, as a representative of all the Investor Partner, with respect to the rights and obligations under the Transaction Documents.

#### *TRANSFERS BY THE SPONSORS*

- 10.6 **Investor Consents Required for Share Transfers:** Subject to Article 10.7, without the prior written consent of the Investor, the Sponsors shall not, directly or indirectly, Transfer any of their Shares.
- 10.7 **Exempted Share Transfers:** Notwithstanding anything contained in the Shareholders Agreement and/ or these Articles, each of the Sponsors shall be entitled to freely Transfer their Shares in the Company and their shares in the Group Companies, without the prior consent of the Investor to (subject to providing to the Investor (i) intimation within 15 (fifteen) days of such Transfer, and (ii) an executed copy of a Deed of Adherence) to:
- 10.7.1 a Person in which Sponsor 1 and / or Sponsor 2 individually or collectively with their children and their spouses own 50% (fifty percent) or more of the voting rights, and in whom Sponsor 1 and / or Sponsor 2 have the right to appoint the majority of the board members (a “**Sponsor Controlled Entity**”), provided that, if any such Person ceases to be a Sponsor Controlled Entity, Sponsor 1 and / or Sponsor 2 shall acquire full and unconditional title in and to all of the Shares then held by such Person;
- 10.7.2 Sponsor 1, Sponsor 2, any parent of Sponsor 1 or Sponsor 2, and/or any children of Sponsor 1 or Sponsor 2 and their respective spouses; or
- 10.7.3 a Hindu Undivided Family whose “Karta” is Sponsor 1 (a “**Sponsor HUF**”), provided that, the

Investor has been provided with (i) a PAN card of the Sponsor HUF; and (ii) a declaration signed by each member of the Sponsor HUF stating that the Sponsor 1 is the Karta of the HUF (and is authorized to transact on behalf of the Sponsor HUF) and that they are the only members of the Sponsor HUF.

Each such permitted Transfer of Shares described in Article 10.7 above is referred to as an “**Exempted Transfer**”.

- 10.8 **Sponsor Liability to Continue:** In the event of an Exempted Transfer, the Sponsors shall continue to remain liable to perform all of their duties and obligations under the Transaction Documents and shall ensure that the transferees of Shares comply with the terms of the Transaction Documents.
- 10.9 **Evidence of Control:** The Sponsors shall from time to time, at the request of the Investor, provide reasonable written evidence of their legal and beneficial shareholding and control over a Sponsor Controlled Entity which hold any Shares.
- 10.10 **ROFR and Tag Along do not apply to an Exempted Transfer:** Notwithstanding any other provision of the Shareholders Agreement and/ or these Articles, the provisions of Article 12 (*Right of First Refusal*) and Article 13 (*Tag Along Rights*) shall not apply to any Exempted Transfer.
- 10.11 **No Indirect Transfers by the Shareholders:** Each of the Shareholders covenants and agrees that it and any of its Affiliates holding any shares or voting interests in any Group Company shall not directly or indirectly Transfer any of the shares or voting interests owned by it to any Person or create any Encumbrance over the Shares or voting rights owned by it, except as expressly required or permitted under these Articles and/ or the Shareholders Agreement. The Shareholders agree that the Transfer restrictions on them in the Shareholders Agreement and/ or these Articles shall not be avoided by the holding of Shares / shares in any Person that can itself be sold in order to dispose of an interest in Shares free of such restrictions. Any Transfer, issuance or other disposal of any shares (or other interests) of a Person Controlled by a Shareholder which holds, directly or indirectly, any shares in any Group Company shall be treated as being a Transfer of the shares held by a Shareholder and the provisions of these Articles and / or the Shareholders Agreement that apply in respect of the Transfer of Shares by such Shareholder shall apply in this respect.
- 10.12 **ROFR to Apply:** Subject to the provisions of Article 12 (*Right of First Refusal*), the Investor shall be permitted to freely Transfer all or some of the Shares owned by it at any point in time.
- 10.13 **ROFR inapplicable in certain circumstances:** Notwithstanding the provisions of Article 10.12 and Article 13, the provisions of Article 12 (*Right of First Refusal*) shall not apply to:
- 10.13.1 any Transfer of Shares by the Investor to an Affiliate or to the Sponsors (or an Affiliate of the Sponsors) provided that, (i) if any such Affiliate of the Investor ceases to be an Affiliate then the Investor shall acquire full and unconditional title in and to all of the Shares then held by such Affiliate; and (ii) an ‘Affiliate’ shall not include any portfolio company of the Investor whose primary business is to engage in the sale of automobiles;
- 10.13.2 any Transfer of Shares by the Investor pursuant to Article 10.5;
- 10.13.3 any Transfer of Shares by the Investor: (i) subsequent to the occurrence of an Event of Default, and/or (ii) pursuant to an IPO; and
- 10.13.4 any Transfer of Shares by the Investor to a Third Party in accordance with Article 73 (*Change in Law*) and / or Article 74 (*Divestment Ruling*).

Each such permitted Transfer of Shares described in Article 10.13 above is referred to as an “**Investor Free Transfer**”.

- 10.14 **Assistance with a Transfer of Shares by the Investor:** In the event of any proposed Transfer of Shares by the Investor pursuant to any of the provisions of these Articles (except under Articles 10.13.1 and 10.13.2), the prospective Third Party purchaser shall have the right to conduct legal, financial, technical, environmental and tax due diligence on the Group Companies and to interact with the Sponsors, the directors, the management team and the senior employees of the Group Companies for the purpose of evaluating the proposed Transfer of

Shares. The Sponsors and the Company hereby consent to such right and shall provide all reasonable assistance in this regard to assist in the completion of such evaluation and in the proposed Transfer of Shares. The Investor shall be entitled to divulge Confidential Information in respect of the Group Companies to such prospective Third Party purchaser for the purpose of enabling such prospective Third Party purchaser to evaluate the proposed Transfer of Shares, which shall not be deemed to be a breach of the confidentiality obligations of the Investor under the Shareholders Agreement and / or these Articles, provided that the prospective Third Party purchaser has entered into a confidentiality and non-disclosure agreement in form and substance consistent with standard business practices and a copy of such executed agreement has been provided to the Sponsors.

- 10.15 **Customary Warranties:** The Company and the Sponsors shall provide such representations, warranties and undertake such covenants as may be reasonably required by the prospective Third-Party purchaser in the event of any proposed Transfer of Shares by the Investor pursuant to any of the provisions of the Shareholders Agreement and/ or these Articles. The Third-Party purchaser shall be deemed to be acting reasonably if the representations, warranties and covenants required by it are no more onerous than those contained in the Transaction Documents.
- 10.16 **Transfer of Shares by the Investor to its Affiliates:** In relation to any Transfer of Shares then held by the Investor in whole to any of its Affiliates, all rights and obligations of the Investor under the Shareholders Agreement and/ or these Articles shall stand transferred / assigned to such Affiliate. In relation to any part transfer of Shares then held by the Investor to its Affiliates, at the election of the Investor, only those rights and obligations (under the Shareholders Agreement and/ or these Articles) as are identified by the Investor shall stand transferred / assigned to such Affiliate.
- 10.17 **Full Transfer of Shares by the Investor to a Third Party Transferee:** In relation to any Transfer of all the Shares then held by the Investor and / or its Affiliates to a Third Party transferee, all rights and obligations of the Investor under the Shareholders Agreement and/ or these Articles shall stand transferred / assigned to such Third Party transferee.
- 10.18 **Part Transfer of Shares by the Investor to a Third Party Transferee:** In relation to any Transfer of a portion of the Shares then held by the Investor and / or its Affiliates, at the election of the Investor, all rights and obligations of the Investor under these Articles shall stand transferred / assigned to such Third Party transferee (with both the transferor and transferee being entitled to exercise such rights and being subject to such obligations, as if references to the Investor mean separate references to the transferor and the transferee), except that (A) such Third Party transferee shall have the right to nominate director (s) in accordance with Article 32.1, only if its shareholding in the Company is equal to or higher than 12% (on a fully diluted basis); and (B) the following rights may only be exercised by:(i) such shareholder, from among the Investor, its Affiliate or its Third Party transferee (as the case may be), who holds the highest shareholding percentage in the Company, provided that (xx) a Third Party transferee may exercise such rights only if it holds more than 12% of the Company's shareholding (on a fully diluted basis), or (yy) in the event the Investor, its Affiliate or the Third Party transferee (in the case of the Third Party transferee, so long as it holds equal to or more than 12% of the Company's shareholding on a fully diluted basis) (as the case may be) have an identical shareholding percentage, then such shareholder shall be the Person identified by the Investor; or (ii) the Investor, its Affiliates and / or its Third Party transferee, acting and voting together as 1 (one) entity / block (as the case may be):
- 10.18.1 Article 36.4 and Article 36.5 (*Quorum for Board Meeting*);
- 10.18.2 Article 40.4 and Article 40.5 (*Quorum for Shareholders Meeting*);
- 10.18.3 Article 41.2 (*Affirmative Rights of the Investor*) and Article 41.3 (*Manner of Approving Reserved Matters*);
- 10.18.4 Articles 16 (*Exit*), 17 (*Initial Public Offering*), 18 (*Conduct of QIPO*), 19 (*Investor's Listing*), 20 (*Other Terms; Registration Rights*) and 21 (*Sponsor Buy-out Right / Investor Put Option*);
- 10.18.5 Articles 26 (*Event of Default*), 27 (*Completion of Transfer of the Default Sale Shares and Payment of the Default Sale Price*) and 28 (*Costs*); and
- 10.18.6 Article 44.3.1 and 44.3.2 (*New Business*).

For the avoidance of doubt, upon exercise of rights pursuant to Articles 16 (*Exit*), 17 (*Initial Public Offering*),

18 (Conduct of QIPO), 19 (Investor's Listing), 20 (Other Terms; Registration Rights), 21 (Sponsor Buy-out Right / Investor Put Option), 26 (Event of Default), 27 (Completion of Transfer of the Default Sale Shares and Payment of the Default Sale Price) or 28 (Costs), should the Sponsors or the Company be required to purchase (or procure the sale of) Shares under the terms of Article 16 (Exit), 17 (Initial Public Offering), 18 (Conduct of QIPO), 19 (Investor's Listing), 20 (Other Terms; Registration Rights), 21 (Sponsor Buy-out Right / Investor Put Option), 26 (Event of Default), 27 (Completion of Transfer of the Default Sale Shares and Payment of the Default Sale Price) or 28 (Costs), the benefit of such rights shall also be available to each of the Investor, its Affiliates and / or its Third Party transferee (as the case may be).

## 11. APPROVAL OF SALE TRANSACTIONS; EXTENSION OF TIME LIMITS

If any approval of a Governmental Authority is, in the reasonable opinion of the Investor, required for a Transfer of Shares under these Articles, the Investor shall, and where required under applicable law, the Company and / or the Sponsors shall, immediately make an application thereof and shall take in good faith all such reasonable actions as may be necessary or desirable to obtain such approval and the Parties shall act in good faith and provide the necessary cooperation to obtain such approval in an expeditious manner. The time taken for obtaining such approvals shall be excluded from the time limits or periods set out for the Transfer of the Shares under these Articles.

## 12. RIGHT OF FIRST REFUSAL

12.1 Subject to Article 10.13 and Article 12.6, in the event a Shareholder proposes to sell its Shares (such Shareholder, the "**Transferring Party**"), the other Shareholders (each such Shareholder, a "**Non-Transferring Party**") shall have a right of first refusal with respect to such sale in the manner set out in this Article 12.1 ("**First Right**").

12.2 **Issuance of an Offer Notice:** The Transferring Party shall give notice (the "**Offer Notice**") to the Non-Transferring Party specifying (i) the name of the proposed purchaser ("**Prospective Purchaser**"); (ii) the number of Shares that are proposed to be transferred to the Proposed Purchaser (the "**Offered Shares**"); (iii) sale price of such Offered Shares ("**Offer Price**"); and (iv) any other terms and conditions in connection therewith.

12.3 **ROFR Acceptance Notice:** For a period of 21 (twenty one) days after delivery of the Offer Notice (the "**ROFR Period**"), any of the Non-Transferring Parties shall have the right to exercise the First Right by delivering within the ROFR Period, a written notice communicating its desire to purchase the Offered Shares in accordance with the terms and conditions of the Offer Notice (a "**ROFR Acceptance Notice**") to the Transferring Party. The failure of the Non-Transferring Party to issue a ROFR Acceptance Notice to the Transferring Party within the ROFR Period shall be deemed to be a waiver of its First Right. The issuance of a ROFR Acceptance Notice shall be a binding and irrevocable commitment of the Non-Transferring Party to consummate the sale and purchase of the Offered Shares in accordance with Article 12.5.

12.4 **Third Party Sale:** In the event the Non-Transferring Party is the Sponsors, and they do not issue a ROFR Acceptance Notice in accordance with Article 12.3 or fail to undertake the closing (i) in accordance with Article 12.5, and (ii) within a period of 10 (ten) Business Days from the date of receipt of the ROFR Acceptance Notice (the "**ROFR Closing Period**"), the Transferring Party shall be free to transfer the Offered Shares to the Prospective Purchaser for a consideration which is not less than the Offered Price, provided that (A) the consideration may be below the Offer Price by up to 10% (ten percent); and (B) the Transfer is made within 6 (six) months after: (X) the issuance of the Offer Notice (if no ROFR Acceptance Notice issued), or (Y) the expiry of the ROFR Closing Period, whichever is later. If such a Transfer does not occur within such 6 (six) month period for any reason, the restrictions provided in this Article 12 shall again become effective, and subject to the provisions of these Articles, no Transfer of Shares may be made by the Transferring Party thereafter without again making an offer to the Non-Transferring Party in accordance with this Article 12.

12.5 **ROFR Closing:** At the closing, the Transferring Party shall deliver certificates representing the Offered Shares (indicated in the Offer Notice), accompanied by duly executed instruments of Transfer or duly executed Transfer instructions to the relevant Persons. At such closing, all of the parties to the transaction shall also execute such additional documents as may be necessary to effect the sale of the Offered Shares to the Non-Transferring Party. Such Offered Shares shall be free and clear of any Encumbrance, and the Transferring Party shall so represent and warrant and shall further represent and warrant that it is (i) the beneficial and record owner of such Offered Shares; and (ii) is duly organized and has all requisite authority to enter into such

Transfer, and that such Transfer will not violate any organizational documents or any agreement binding on the Transferring Party. The Non-Transferring Party shall deliver at such closing payment in full of the Offer Price in accordance with the terms set forth in the Offer Notice.

- 12.6 **ROFR Treatment of Specific Transfers:** (A) In the event the Transferring Party is an Investor and / or a transferee of the Investor, all references to a Non-Transferring Party in this Article 12 shall mean a reference only to Sponsor 1. However, Sponsor 1 may purchase the Offered Shares through one or more Persons as he may deem fit. (B) In the event the Transferring Party is a Sponsor and/or an Affiliate of the Sponsor, all references to a Non-Transferring Party in this Article 12 shall mean a reference only to the Investor.

### 13. TAG ALONG RIGHTS

- 13.1 **Tag Along Notice:** Subject to Article 10.11, if the Transferring Party is any of the Sponsors and / or their respective Affiliates, regardless of whether the Investor delivers any ROFR Acceptance Notice in respect of such Shares that are proposed to be Transferred in accordance with Article 12 (*Right of First Refusal*), the Investor will have the right to Transfer up to such number of Shares which is equal to: (i) its Relevant Proportion of the Offered Shares (e.g. if (A) the Investor's shareholding percentage on a fully diluted basis is 30% (thirty percent) and that of the Transferring Party is 70% (seventy percent), and (B) the number of Offered Shares is 35 Equity Shares, then the Relevant Proportion would be  $30/70$  and the number of Equity Shares the Investor would be entitled to transfer is  $(30/70) * 35 = 15$  Equity Shares), or (ii) if the proposed Transfer of Shares would result in a Change of Control of the Company, all of the Shares then held by the Investor, by delivering a written notice to the Transferring Party (the "**Tag Along Notice**") during the ROFR Period, which notice shall specify the number of Shares proposed to be Transferred by the Investor (the "**Tag Along Shares**"). If the Investor fails to deliver the Tag Along Notice to Sponsor 1 on or before the expiration of the ROFR Period, the Investor shall be deemed to have waived the rights afforded to the Investor under this Article 13.1.
- 13.2 **Sale of Tag Along Shares:** In the event that the Investor delivers a Tag Along Notice to Sponsor 1, the Sponsors shall ensure that the Prospective Purchaser also shall acquire, together with the relevant Offered Shares, the Tag Along Shares for the same consideration and upon the same terms and conditions as set forth in the Offer Notice (including by reducing the number of Offered Shares to permit the sale of the required number of Tag Along Shares).
- 13.3 **Simultaneous Sale of Offered Shares and Tag Along Shares:** The Sponsors and/or their Affiliates shall not be entitled to sell any Offered Shares to the Prospective Purchaser unless the Prospective Purchaser simultaneously purchases and pays for all the Tag Along Shares.
- 13.4 **Investor to Provide Limited Warranties:** The Investor shall not be required to make any representation or warranty to the Prospective Purchaser, other than as to good title to the Shares held by the Investor, the absence of Encumbrances with respect to such Shares, customary representations and warranties concerning the Investor's power and authority to undertake the proposed transfer, and the validity and enforceability of the Investor's obligations in connection with the proposed transfer. It is clarified that the Investor shall (a) make such representation or warranty to the Prospective Purchaser on a several basis and in no event whatsoever, on a joint basis with any of the Transferring Parties; (b) not be liable to the Prospective Purchaser for any amounts in excess of the relevant purchase price received by the Investor; and (c) benefit from the same provisions of the definitive agreements as the Sponsors.
- 13.5 **Delivery of Equity Shares:** The Investor may effect its participation in the proposed sale by delivering to the Prospective Purchaser on the date of the proposed closing of the Transfer of Shares by the Sponsors, 1 (one) or more share certificates together with the 1 (one) or more share transfer forms for transfer to the Prospective Purchaser, representing, the number of Tag Along Shares; provided, however, that if the Prospective Purchaser objects to the delivery of any of CCPS in lieu of Equity Shares, the Investor shall be entitled to first convert its CCPS into Equity Shares and deliver Equity Shares as provided above. The Sponsors and the Company agree that the completion of the sale and transfer of the Offered Shares and the Tag Along Shares shall be deferred to a date which is 5 (five) Business Days (or to the next Business Day if such date is not a Business Day) after the issuance of the relevant number of Equity Shares to the Investor. Except as provided in these Articles, no other documentation shall be required from the Investor as a condition to participating in the proposed sale.
- 13.6 **No Other Restrictions on the Investor:** In connection with any Transfer of Shares pursuant to Articles 10 to 15, the Investor shall not be required to agree to any covenant to not compete or to not solicit customers, employees or suppliers of any party to the proposed Transfer.



#### **14. PRE-EMPTION RIGHT OF ALL SHAREHOLDERS**

- 14.1 Except as may be mutually agreed by the relevant Parties, each Shareholder shall have the right (but not the obligation) to participate in any issue of new Shares (the “New Issuance”) on the terms and conditions of the New Issuance so that each Shareholder is able to maintain its Relevant Proportion. Notwithstanding the foregoing, a New Issuance shall not include an issuance of Shares in connection with an IPO or a conversion of the CCPS into Equity Shares.
- 14.2 In the event that a Shareholder does not subscribe to all or part of its entitlement of the New Issuance, the subscribing Shareholders will have the right (but not the obligation) to subscribe to some or all of the unsubscribed portion of the New Issuance in accordance with their respective Relevant Proportion. For the avoidance of doubt, the shareholding of the non- subscribing Shareholder will accordingly be diluted and the Relevant Proportion of the Shareholders will be adjusted to reflect such dilution.
- 14.3 Subject to Article 14.2, in the event the Shareholders do not subscribe to all of the New Issuance, the Board shall have the right to offer the unsubscribed part of the New Issuance to a Third Party at the price and on the terms offered to the Shareholders. Upon such subscription of New Issuance by the Third Party the shareholding of the Shareholders will accordingly be diluted and the Relevant Proportion of the Shareholders will be adjusted to reflect such dilution.
15. In the event that the Company changes the number of Shares issued and outstanding as a result of a reclassification, stock split (including a reverse stock split), stock dividend or distribution, recapitalisation, merger, subdivision, issuer tender or exchange offer, or other similar transaction, the number of Shares held by the Shareholders shall be equitably adjusted to enable the Shareholders to maintain their Relevant Proportion in the Company.

#### **16. EXIT**

- 16.1 The Company and the Sponsors shall be required to undertake or procure any of the following actions any time after the fourth anniversary of the Completion Date:

16.1.1 cause a QIPO in accordance with Articles 17 to 20; or

16.1.2 if the Investor seeks assistance from the Company and the Sponsors to find other financial investors for all the Shares held by it and its Affiliates in the Company, then the Company and the Sponsors will provide such requested assistance to the Investor (the “**Exit Purchase**”).

For the avoidance of doubt, the Parties agree that the QIPO is their preferred exit option, and the Sponsors shall accordingly prioritize and use best efforts in procuring a QIPO over an Exit Purchase.

- 16.2 The Investor shall not be required to provide any representations and warranties in connection with an Exit Purchase or QIPO to any Person including any underwriter, broker, Recognised Stock Exchange or any Governmental Authority (other than as to, in case of a sale of Shares, good title to the Shares held by the Investor, the absence of Encumbrances with respect to such Shares, customary representations and warranties concerning the Investor’s power and authority to undertake the proposed Transfer, and the validity and enforceability of the Investor’s obligations in connection with the proposed Transfer).
- 16.3 In case of an Exit Purchase, such transaction shall be concluded (with full payment being received by the Investor) within 60 (sixty) days of execution of the relevant share purchase or other agreements, excluding the time that may be required for obtaining any approvals from a Governmental Authority for consummating such transaction. The Company shall bear all cost and expenses incurred pursuant to and incidental to an Exit Purchase, provided that, the Company shall not be liable for any costs and expenses in excess of USD125,000 (United States Dollar One hundred twenty five thousand). However, in the event applicable law does not permit the Company to bear such cost and expenses, subject to applicable law, the Investor will bear such cost and expense incurred pursuant to and incidental to an Exit Purchase.

#### **17. INITIAL PUBLIC OFFERING**

- 17.1 In the event the Company and Sponsors undertake or procure a QIPO and the Investor approves such QIPO, the

provisions of Articles 17 to 20 shall apply.

#### *INVESTOR APPROVAL TO A QIPO*

##### **17.2 Approval prior to the fourth anniversary of the Completion Date**

In the event the Investor does not approve a proposed QIPO in accordance with Article 41.2.8 prior to the fourth anniversary of the Completion Date: (i) the Company and the Shareholders shall not proceed with an IPO and the Investor shall in such case have no liability for any IPO related costs, if any, incurred by the Company and/or any other Shareholders; and (ii) such action of the Investor shall not prejudice any right or remedy of the Investor under these Articles.

##### **17.3 Approval post the fourth anniversary of the Completion Date**

In the event (i) a Top 5 Investment Bank provides the Board a reasonable proposal at any time after the fourth anniversary of the Completion Date to undertake a QIPO on a best efforts basis, in accordance with: (A) the then prevailing market practice and industry standard; and (B) in accordance with Article 18 below, and which proposal sets forth all material terms under which the QIPO is proposed to be conducted, including the matters described in Article 18.1; and (ii) the Investor does not approve such a QIPO in accordance with Article 41.2.8 based on information then made available to the Investor, then, the Investor shall cease to have the right to exercise its Put Option.

For the purposes of this Article 17.3, a “**Top 5 Investment Bank**” means a Person which at the relevant time is listed amongst the top 5 in the most recent edition of a ranking / league table of investment / merchant banks (engaged in capital markets activity in India) published by any of Bloomberg, Thomson Reuters, S&P Capital IQ or another financial services information provider acceptable to the Investor.

#### **18. CONDUCT OF QIPO**

18.1 All material terms of the QIPO including the following matters shall be determined by the Company and the Sponsors in consultation with the Merchant Bank (as appointed below) and shall be discussed with and be subject to the approval of the Investor:

- (i) the type of Shares and quantum of Shares to be offered in the QIPO, provided that, the QIPO must result in Shares constituting (i) a minimum of 30% (thirty percent) of the share capital of the Company (on a fully diluted basis) being listed on a Recognized Stock Exchange; and (ii) at least 75% (seventy five percent) of the Shares then held by the Investor being offered by the Investor as part of the offer for sale component of the QIPO;
- (ii) appointment of merchant banker / book running lead manager (“**Merchant Bank**”), who shall be jointly nominated by the Investor and Sponsor 1;
- (iii) appointment of registrars, financial advisors, issue managers and other intermediaries; (iv) terms of the prospectus; and
- (iv) the stock exchange(s), on which the Shares are to be listed, shall be a Recognized Stock Exchange.

18.2 The Company and the Sponsors shall also ensure that all documents relating to the QIPO, including, without limitation, any prospectus or other submissions made to the applicable regulatory authorities and / or governmental agencies are made available to the Investor (and its advisors) for review and comment and that they are approved by both the Investor and Sponsor 1 prior to submission to such authorities and / or agencies, and shall provide to the Investor a customary legal opinion of counsel to the Company with respect to such QIPO, addressed to the Investor and in form and substance jointly acceptable and approved by the Investor and Sponsor 1.

18.3 In respect of the offer for sale component of the QIPO, the right of the Shareholders other than the Investor to tender their Shares in such offer for sale shall, at all times, be subject to the right of the Investor and its Affiliates to first tender any or all of the Shares held by the Investor and/or its Affiliates in such offer for sale.

18.4 In the event the Company undertakes a QIPO and the Investor has approved such QIPO, each of the Shareholders shall cooperate to facilitate the QIPO, including without limitation (A) the exercise of its voting rights at relevant

Shareholder meetings, and (B) causing its nominated Directors to execute all documents as required by the Company from time to time in connection with the QIPO. The Parties agree that they shall cooperate in optimising the size of the QIPO, which shall be determined by the Merchant Bank subject to the Investor's rights under Articles 17 to 20.

## 19. INVESTOR'S LISTING

- 19.1 In the event that the Company has not completed a QIPO by the fifth anniversary of the Completion Date for any reason whatsoever, the Investor shall without prejudice to its other rights under these Articles and applicable law have the right to appoint a merchant bank, cause the Company to make an application for admission of its Shares to trading on a Recognised Stock Exchange and effect an IPO and/or list its Shares on a Recognised Stock Exchange through an offer for sale mechanism, all at the cost and expense of the Company. For the avoidance of doubt, the provisions of Article 18 shall apply in the same manner to such IPO as if the Company had itself appointed the Merchant Bank. The Company shall (and the Sponsors shall procure that the Company shall) provide such assistance and take such other action as required by applicable law or regulation (including any requirements of the relevant Recognised Stock Exchange) and as shall be advised by the Merchant Bank as being necessary or desirable to maximise the success of the IPO.
- 19.2 In the event that the Company is conducting an IPO by means of an offer for sale mechanism pursuant to Article 19.1 above, the Shareholders expressly acknowledge and agree that the Investor shall tender the Shares owned by it for sale under the IPO; provided that, in the event that the minimum number of Shares required to be tendered under the then applicable law is more than the number of Shares legally and beneficially offered by the Investor, (i) the Sponsors shall tender such minimum number of Shares owned by them for sale under the IPO, and/or (ii) the Company shall issue such minimum number of Shares under the IPO, so as to permit the Investor to conduct the IPO.

## 20. OTHER TERMS; REGISTRATION RIGHTS

- 20.1 **Costs and expenses:** The Parties expressly understand, acknowledge and agree that the Company shall be responsible and liable for (i) all costs and expenses incurred in connection with the QIPO (including without limitation underwriting, distribution and selling costs), and (ii) any breach of the Company's representations, warranties, covenants, obligations and undertakings set forth in any agreement, instrument or other document in relation to the QIPO, provided that if any Shareholder offers Shares for sale as a part of the QIPO, the selling and distribution costs specifically relating to any offer for sale of Shares by such Shareholder shall be borne that Shareholder only to the extent required by the applicable law or a Governmental Authority, unless otherwise agreed between the Company and the Investor in writing.<sup>5</sup>
- 20.2 **Lock-in:** Any Shares that are subject to a "lock in" as "promoter shares" after the IPO shall be Shares held by the Sponsors and the Shares owned by the Investor shall not be subject to any "lock in" as "promoter shares". The Parties agree and acknowledge that the Investor is not a "promoter" of the Company and shall not be represented as a "promoter" for any reason whatsoever including in any regulatory or other filing by the Company and the Sponsors with any Governmental Authority. Nothing in these Articles shall require the Investor to do or omit to do anything that may result in them becoming a "promoter" of the Company under the relevant Securities and Exchange Control Board of India regulations.
- 20.3 **Failed IPO:** In the event of a Failed IPO of the Company, if the Investor so determines, the Parties shall, subject to applicable laws, take all necessary steps and cooperate to ensure that, to the extent any changes were made pursuant to the IPO, all the original terms and conditions as under these Articles in existence prior to the attempted IPO are reinstated and made effective, including with respect to amending the Articles of Association, etc. For the purpose of this Article 20, a "Failed IPO" shall be deemed to have occurred in the event of a failure to list and trade the Company's securities on a Recognised Stock Exchange within a period of 6 (six) months from approval of the draft offer document by the Securities and Exchange Board of India for any reason whatsoever.

## 21. SPONSOR BUY-OUT RIGHT / INVESTOR PUT OPTION

- 21.1 **Put Option:** If by the fifth anniversary of the Completion Date, (i) the Company and the Sponsors fail to undertake a QIPO; and (ii) the Investor does not sell all its Shares pursuant to an Exit Purchase, then the Investor may elect to sell all the Shares held by the Investor ("**Put Option Securities**") to the Sponsors on the terms set

---

<sup>5</sup> Article 20.1 has been amended by Members of the Company by passing a special resolution at extraordinary general meeting held on 11 January 2021

out in this Article 21 (the “**Put Option**”). The Sponsors may purchase the Put Option Securities at the Put Option Purchase Price in accordance with the manner set out in this Article 21.

- 21.2 **Exercise Notice and Calculation of the Put Option Purchase Price:** The Put Option shall be exercised by an Investor by issuing an exercise notice to Sponsors (“**Exercise Notice**”), which Exercise Notice shall state that the purchase price of the Put Option Securities (“**Put Option Purchase Price**”) shall be equivalent to the fair market value of the Put Option Securities (determined in the manner provided below) (“**FMV**”).
- 21.3 **Appointment of the Valuer:** Within 5 (five) days of the issuance of the Exercise Notice, the Investor and Sponsor 1 shall jointly appoint a valuer to compute the FMV of the Put Option Securities (the “**Valuer**”), which Valuer shall be any one of the Valuer Banks. In the event the Investor and Sponsor 1 fail to jointly appoint the Valuer in the prescribed time period, the Investor may make a reference to either the President of the Bombay Chamber of Commerce & Industry or the Chairman of the International Chamber of Commerce to nominate any one of the Valuer Banks to act as the Valuer, whose nomination shall be binding on each of the Parties. The fees and expenses of the Valuer appointed pursuant to this Article 21.3 shall be borne by the Company, and the Investor shall be promptly reimbursed by the Company for any fees and expenses paid by it to the Valuer (if any).
- 21.4 **Calculation of the FMV:** The FMV will be determined by the Valuer on the basis of the Audited PAT (as per the latest available audited financial statements of the Company) multiplied by the Adjusted P/E Multiple. For the purposes of this Article 21.4, the “**Adjusted P/E Multiple**” will be derived as follows:

LTM International P/E Multiple\* 85%

“**LTM International P/E Multiple**” means the median of the last twenty-four months price- to-earnings multiple (i.e. the twenty four months immediately preceding the date of the Exercise Notice), sourced from S&P Capital IQ (or such other financial information provider considered appropriate by the Valuer), of:

- (i) the 5 (five) largest, by market capitalization, publicly traded auto dealership companies in the United States of America;
  - (ii) the 5 (five) largest, by market capitalization, publicly traded auto dealership companies in Europe; and
  - (iii) the 5 (five) largest, by market capitalization, publicly traded auto dealership companies in Asia.
- 21.5 **Valuation Notice:** The Valuer shall independently determine the FMV within a period of 30 (thirty) days of its appointment, or such longer period, if any, as may be (i) agreed in writing between the Sponsors and the Investor; and/or (ii) requested by the Valuer to complete its valuation exercise. The Valuer shall state the FMV of the Put Option Securities determined as above by giving a written notice to the Investor and Sponsor 1, along with a copy of its valuation report (“**Valuation Notice**”). For the avoidance of doubt, (a) the Valuer appointed under the provisions of this Article 21 is an expert and not an arbiter and any valuation provided by the Valuer will not be the subject matter of arbitration proceedings pursuant to these Articles; and (b) the Valuation Notice will be final and binding on all Parties.
- 21.6 **Acceptance or Rejection by the Sponsors:** Within 5 (five) days of the delivery of the Valuation Notice to Sponsor 1 (“**Acceptance Period**”), the Sponsors shall address a written notice to the Investor, either accepting to purchase the Put Option Securities at the Put Option Purchase Price or declining to purchase the Put Option Securities (“**Sponsor Decision Notice**”). The failure of the Sponsors to give a Sponsor Decision Notice within the Acceptance Period shall result in the Sponsors being deemed to have declined the Investor’s offer to sell the Put Option Securities. If the Sponsors have agreed to purchase the Put Option Securities within the Acceptance Period, their Sponsor Decision Notice shall comprise an irrevocable and unconditional offer by the Sponsors to purchase the Put Option Securities at the Put Option Purchase Price, and the Transfer of the Put Option Securities to the Sponsors will be completed within a period of 10 (ten) days from the expiry of the Acceptance Period (excluding the time that may be required for obtaining any approvals from a Governmental Authority for consummating such transaction).
- 21.7 **Put Option Closing:** At the closing, the Investor shall deliver certificates representing the Put Option Securities, accompanied by duly executed instruments of Transfer or duly executed Transfer instructions to the relevant Persons. The Put Option Securities shall be free and clear of any Encumbrance, and the Investor shall so represent and warrant and shall further represent and warrant that it is (i) the beneficial and record owner of such Put Option

Securities; and (ii) is duly organized and has all requisite authority to enter into such Transfer, and that such Transfer will not violate any organizational documents or any agreement binding on the Investor. The Sponsors shall deliver at such closing payment in full of the Put Option Purchase Price in accordance with the terms set forth in the Exercise Notice.

- 21.8 **Assistance with the Sale of Put Option Securities:** The Company and the Sponsors hereby agree and undertake to take all steps to consummate the transactions contemplated under this Article 21 and provide full cooperation to the Investor and its advisors in relation to the same, including providing (i) the Valuer access to, and ensuring the provision of assistance by, relevant management, professional advisers and accountants of the Company, and (ii) information relating to the Company in the manner required by the Valuer.

## 22. INVESTOR CONSENT FOR GRANT OF MORE FAVOURABLE RIGHTS

The Company and the Sponsors agree and acknowledge that neither there exists, nor shall they enter into any agreement, arrangement or understanding with any other Shareholder or potential shareholder of the Company granting or to grant such Shareholder or potential Shareholder any rights in the Company without the Investor's consent. Further, without prejudice to the other rights of the Investor herein, the Company and the Sponsors shall not provide any Person with any rights in relation to the Company or its Shares, which are more favourable than those provided to the Investor hereunder or issue any new Shares, to any Person, on terms (including price) more favourable than those provided to the Investor, except with the Investors' written consent or as provided in these Articles.

## 23. RESET OF INVESTOR RIGHTS

Notwithstanding anything contained herein or in these Articles but subject to applicable law, in the event that any favourable rights or more favourable terms are granted and / or have already been granted by the Company to any Person, which rights or terms are not available to the Investor, such rights or terms shall automatically and also *ipso facto* be deemed to be available to / will be granted to the Investor unless otherwise agreed to by Investor, in writing, and the Parties shall take all such necessary steps in order to ensure satisfactory exercise of such rights by the Investor, including amending the Articles of Association of the Company to give effect to such modification of rights of the Investor.

## 24. NO IMPEDIMENT TO INVESTOR RIGHTS

For the avoidance of doubt, no rights that may be granted by the Company or the Sponsors to any other Person shall in any manner impede or restrict the rights of the Investor under the Shareholders Agreement and / or these Articles to the fullest extent possible.

## 25. LIQUIDATION PREFERENCE

- 25.1 In relation to any outstanding CCPS, upon a Winding Up, the provisions of Schedule 1 (*Terms and Conditions of the Investor Shares*) shall apply.
- 25.2 In relation to all Equity Shares held by the Investor at the relevant time (including any Conversion Shares) ("**Investor Equity Shares**"), in the event of a Winding Up, from the total proceeds from such Winding Up remaining after discharging, or making provision for discharging, the liabilities of the Company that are payable in priority to Equity Shares, the Investor shall receive in priority to all other holders of Equity Shares, the higher of:
- 25.2.1 all amounts invested by the Investor in acquiring the Investor Equity Shares (including amounts invested in the CCPS which converted into the Conversion Shares); or
- 25.2.2 the Investor's Relevant Proportion of all the assets and funds of the Company legally available for distribution to the Shareholders upon such Winding Up.
- 25.3 In the event the amount, if any, received by the Investor upon Winding Up is less than the amounts it is entitled to receive pursuant to Article 25.2, the Shareholders (other than the Investor) shall be jointly and severally liable to pay the shortfall amount to the Investor, provided that such shortfall amount payable by the relevant Shareholders shall not exceed the amounts received by them as a result of the Winding Up. To the extent necessary to accomplish the preferences set forth in Article 25.2, each Shareholder (except the Investor) waives its

respective rights and entitlements to its share in any payment pursuant to a Winding Up and to the extent such payments are made to, or received by, any Shareholder, such Shareholder shall jointly and severally hold the payments received by it in trust for the Investor.

## 26. EVENT OF DEFAULT

26.1 An “**Event of Default**” shall mean any of the following:

26.1.1 the Sponsors or any of the Group Companies commits a material breach of its obligations under (A) Articles 9A (*Covenants*), 10.1 to 10.5 (*Transfers by the Shareholders; General Restrictions*), 10.6 to 10.11 (*Transfers by the Sponsors*), 12 (*Right of First Refusal*), 13 (*Tag Along Rights*), 14 (*Pre-emption Right of all Shareholders*), 21 (*Sponsor Buy-Out Right / Investor Put Option*), 39A (*Accounts and MIS Reports*), 41 (*Board and Shareholders’ Voting*), 43 (*Ability of Sponsors to Engage in Other Business*), 45 (*Sponsor Representations*), 46 (*Other Information*), 47 (*Annual Budget*), 48 (*Indemnification under the Shareholders Agreement*), 48A (*Indemnification under the Share Subscription and Purchase Agreement*) and 58 (*Inspection*) and Schedule 1 (*Terms and Conditions of the Investor Shares*); or (B) Clause 8 (*Indemnities*) of the Share Subscription and Purchase Agreement, and fails to remedy the breach within 45 (forty five) days of being specifically required in writing to do so by the Investor; or

26.1.2 an Insolvency Event occurs in respect of any of the Sponsors and/or the Group Companies.

26.2 On or any time after the occurrence of an Event of Default, the Investor may (in its sole and absolute discretion) (i) serve a notice in writing (a “**Default Notice**”) on the Sponsors informing them that an Event of Default has occurred; (ii) require the Sponsors, in such Default Notice, to purchase the Default Sale Shares (as defined in Article 26.3 below) at the Default Sale Price (to be computed in accordance with Article 26.3 below); (iii) require the Sponsors, their Affiliates and/or the Company to take such actions as may be agreed between the Parties in the Transaction Documents or otherwise; and/ or exercise its rights set out in Paragraph 4.1 of Schedule 1 (*Terms and Conditions of Investor Shares*).

26.3 For the purposes of Articles 26 to 28:

26.3.1 “**Default Sale Price**” shall be an amount which is equal to 115% (one hundred and fifteen percent) of the FMV as determined under Articles 21.3, 21.4 and 21.5, provided that in determining the FMV for the purposes of this Article 26.3.1, all references to Put Option Securities shall be construed to be a reference to the Default Sale Shares (and these Articles shall be accordingly construed);and

26.3.2 “**Default Sale Shares**” means the number of shares proposed to be transferred by the Investor, its Affiliates and/or any Third Party nominated by the Investor (each such Person, an “**EoD Seller**”) to the Sponsors.

26.3.3 An “**Investor Event of Default**” shall mean that the Investor commits a material breach of its obligations under Articles 10.1 to 10.5, Article 10.11, Article 10.12 or Article 12, and has failed to remedy the breach within 45 (forty-five) days of being specifically required in writing to do so by the Sponsors.

26.3.4 On or any time after the occurrence of an Investor Event of Default, the Sponsors may (in their sole and absolute discretion) issue a written notice to the Investor, seeking indemnification from the Investor for any Loss suffered or incurred by the Group Company and/or Sponsors on account of an Investor Event of Default, and be also entitled to all other rights and remedies under applicable law and principles of equity which arise from such Investor Event of Default.

## 27. COMPLETION OF TRANSFER OF THE DEFAULT SALE SHARES AND PAYMENT OF THE DEFAULT SALE PRICE

Within 35 (thirty-five) days of the issuance of the Default Notice, the Sponsors shall make payment in full to the EoD Seller(s) of the Default Sale Price for the Default Sale Shares and the EoD Seller(s) shall execute the necessary instruments of Transfer of the Default Sale Shares in favour of the Sponsors. Such 35 (thirty-five) day period shall exclude the time that may be required for obtaining any approvals from a Governmental Authority for consummating such transaction. Such Default Sale Shares shall be free and clear of any Encumbrance (other than Encumbrances arising hereunder or attributable to actions by the Sponsors), and the EoD Seller(s) shall so represent and warrant

and shall further represent and warrant that it is the beneficial and record owner of such Default Sale Shares. Any stamp duty or fees payable on the transfer of any such Default Sale Shares shall be borne and paid, subject to applicable law, by the Company.

## **28. COSTS**

Notwithstanding any other provision in these Articles, all costs and expenses incurred in connection with the Transfer of the Default Sale Shares under the Articles 26 to 28 (including the fees of the Valuer) shall be borne by the Company, and the Company shall promptly reimburse the Investor and any of its Affiliates for any such costs incurred by the Investor or any of its Affiliates.

## **29. TRANSMISSION OF SHARES**

29.1 On the death of a member, the survivor or survivors where the member was a joint holder, and his nominee or nominees or legal representatives where he was a sole holder, shall be the only persons recognised by the company as having any title to his interest in the shares.

29.2 Nothing in Article 29.1 shall release the estate of a deceased joint holder from any liability in respect of any share which had been jointly held by him with other persons.

29.3 Any person becoming entitled to a share in consequence of the death or insolvency of a member may, upon such evidence being produced as may from time to time properly be required by the Board and subject as hereinafter provided, elect, either—

- (a) to be registered himself as holder of the share; or
- (b) to make such transfer of the share as the deceased or insolvent member could have made.

29.4 The Board shall, in either case, have the same right to decline or suspend registration as it would have had, if the deceased or insolvent member had transferred the share before his death or insolvency. If the person so becoming entitled shall elect to be registered as holder of the share himself, he shall deliver or send to the company a notice in writing signed by him stating that he so elects. If the person aforesaid shall elect to transfer the share, he shall testify his election by executing a transfer of the share.

29.5 All the limitations, restrictions and provisions of these regulations relating to the right to transfer and the registration of transfers of shares shall be applicable to any such notice or transfer as aforesaid as if the death or insolvency of the member had not occurred and the notice or transfer were a transfer signed by that member.

29.6 A person becoming entitled to a share by reason of the death or insolvency of the holder shall be entitled to the same dividends and other advantages to which he would be entitled if he were the registered holder of the share, except that he shall not, before being registered as a member in respect of the share, be entitled in respect of it to exercise any right conferred by membership in relation to meetings of the company:

*Provided* that the Board may, at any time, give notice requiring any such person to elect either to be registered himself or to transfer the share, and if the notice is not complied with within ninety days, the Board may thereafter withhold payment of all dividends, bonuses or other monies payable in respect of the share, until the requirements of the notice have been complied with.

## **30. CAPITALISATION OF PROFITS**

30.1 The company in general meeting may, upon the recommendation of the Board, resolve—

- (a) that it is desirable to capitalise any part of the amount for the time being standing to the credit of any of the company's reserve accounts, or to the credit of the profit and loss account, or otherwise available for distribution; and
- (b) that such sum be accordingly set free for distribution in the manner specified in Article 30.2 amongst the members who would have been entitled thereto, if distributed by way of dividend and in the same proportions.

30.2 The sum aforesaid shall not be paid in cash but shall be applied, subject to the provision contained in these Article, either in or towards—

- (a) paying up any amounts for the time being unpaid on any shares held by such members respectively;
- (b) paying up in full, unissued shares of the company to be allotted and distributed, credited as fully paid-up, to and amongst such members in the proportions aforesaid;
- (c) partly in the way specified in sub-article (a) of this Article 30.2 and partly in that specified in sub-article (b) of this Article 30.2;
- (d) A securities premium account and a capital redemption reserve account may, for the purposes of this regulation, be applied in the paying up of unissued shares to be issued to members of the company as fully paid bonus shares;
- (e) The Board shall give effect to the resolution passed by the company in pursuance of this regulation.

30.3 Whenever such a resolution as aforesaid shall have been passed, the Board shall—

- (a) make all appropriations and applications of the undivided profits resolved to be capitalised thereby, and all allotments and issues of fully paid shares if any; and
- (b) generally do all acts and things required to give effect thereto.

30.4 The Board shall have power—

- (a) to make such provisions, by the issue of fractional certificates or by payment in cash or otherwise as it thinks fit, for the case of shares becoming distributable in fractions; and
- (b) to authorise any person to enter, on behalf of all the members entitled thereto, into an agreement with the company providing for the allotment to them respectively, credited as fully paid-up, of any further shares to which they may be entitled upon such capitalisation, or as the case may require, for the payment by the company on their behalf, by the application thereto of their respective proportions of profits resolved to be capitalised, of the amount or any part of the amounts remaining unpaid on their existing shares;

30.5 Any agreement made under such authority shall be effective and binding on such members.

### 31. BOARD AND MANAGEMENT

The following persons are the first Directors of the Company namely:

1. Mr. Sanjay Karsandas Thakker; and
2. Mrs. Ami Sanjay Thakker

#### *DIRECTORS AND MANAGEMENT*

### 32. MANAGEMENT

Subject to Article 41.2, the Board and the board of directors of each of the Group Companies shall have responsibility for the supervision and management of the Company and the Group Companies respectively, save in respect of those matters which are specifically reserved for Shareholders under applicable law, or under the terms of these Articles.

32.1 The Board of Directors shall include such Persons who have been nominated for appointment by the Investor (each such director an “**Investor Director**”) and such other Persons who have been nominated for appointment by the Sponsors in accordance with this Article 32.1 (each such director a “**Sponsor Director**”). The Investor shall be entitled to nominate for appointment such number of Investor Directors as is equal to (rounded to the nearest whole number) the Investor’s Relevant Proportion of the then sanctioned strength of the Board, provided



that the Investor shall always be entitled to nominate for appointment at least 1 (one) Investor Director. The Sponsors shall be entitled to nominate for appointment such number of Sponsor Directors as is equal to (rounded to the nearest whole number) the Sponsor's Relevant Proportion of the then sanctioned strength of the Board.

Further, at any time on and after the commencement of listing and trading of the Equity Shares on a Recognised Stock Exchange, until such time that the Investor (together with its Affiliates) continues to hold at least five percent (5%) of the issued and paid-up share Capital of the Company (on a fully diluted basis), the Investor (together with its Affiliates) shall have the right but not an obligation to nominate 1 (one) Director to the Board ("**Investor Director**").<sup>6</sup>

32.2 The Shareholders shall procure that the Board is reconstituted in accordance with the provisions of this Article 32.

32.3 In addition to the appointment of Investor Directors, the Investor shall be entitled to appoint 1 (one) observer on the Board. Such observer shall be entitled to (i) participate in all meetings of the Board and its committees to the same extent to which an Investor Director would be entitled, and (ii) receive all notices and communications to which an Investor Director would be entitled. For the avoidance of doubt, such observer shall not be entitled to vote at the meetings of the Board and its committees.

### **33. REMUNERATION OF DIRECTORS**

*[INTENTIONALLY LEFT BLANK]*<sup>7</sup>

### **34. ALTERNATE DIRECTORS**

34.1 The Investor and the Sponsors shall be entitled to nominate, through each of the Directors which it has nominated, an alternate Director to act in accordance with the Companies Act for that Director. Prior to such nomination, such Director must give at least 14 (fourteen) days' notice to the Company. The Shareholders shall cause the Board to appoint any alternate Director so nominated.

34.2 An alternate director appointed pursuant to Article 34.1 shall be entitled to receive notice of all meetings of the Board and attend and vote at any meeting at which the Director for whom he or she is the alternate is not personally present, and generally in the absence of such Director to do all the things which such Director is authorised or empowered to do. An alternate Director shall be entitled, in the absence of the Director for whom he or she is the alternate:

- (a) to vote on behalf of the Director for whom he or she is the alternate; and
- (b) to be counted as part of the quorum of the Board on behalf of the Director for whom he or she is the alternate.

### *REMOVAL AND REPLACEMENT OF DIRECTORS*

34.3 The Sponsors shall ensure that the Investor Directors are appointed to the board of directors as per the terms of these Articles.

34.4 The Investor and the Sponsor may, at any time and as often as it may require, by written notice to the Company (i) require the removal of either respective nominee Director / his or her alternate Director and shall be entitled to nominate another person in place of such nominee Director / the alternate Director so removed, and (ii) in the event of the resignation, retirement or vacation of office by any of the nominee Director / the alternate Director, nominate another person in place of such nominee Director / the alternate Director. To give effect to the removal or appointment of such Director, all the Shareholders shall exercise to the fullest extent all rights and powers available to them (including by convening a general meeting of Shareholders and exercising their voting rights at meetings of the relevant board of directors and at general meetings of Shareholders) to remove or appoint such Director.

### **35. GOVERNANCE OF GROUP COMPANIES**

---

<sup>6</sup> Article 32.1 has been amended by Members of the Company by passing a special resolution at extraordinary general meeting held on 11 January 2021

<sup>7</sup> Article 33 has been deleted by Members of the Company by passing a special resolution at extraordinary general meeting held on 11 January 2021

- 35.1 The Parties agree that except as specified in Article 35.2 below, the right to appoint and replace directors, quorum and voting arrangements and other rights and procedures with respect to the boards of directors of each Group Company (other than the Company), as well as other management and corporate governance matters of each Group Company (other than the Company), shall mirror those set forth herein in respect of the Company.
- 35.2 Any time after 1 January 2016, if required by the Investor, the Company will appoint 1 (one) Person nominated for appointment by the Investor on the board of directors of each Group Company.
- 35.3 Upon request by the Investor, the Company and the Sponsors shall promptly procure each Group Company to amend their respective charter documents to incorporate the provisions of Article 35.1 and Article 35.2 above in a form and manner satisfactory to the Investor.
- 35.4 The Company and the Sponsors shall not (i) amend the Kolkata Shareholders Agreement without the prior consent of the Investor; and (ii) exercise or waive any rights under the Kolkata Shareholders Agreement without the prior consent of the Investor. The Company and the Sponsors shall promptly provide the Investor with copies of any correspondence sent and/or received by any of them from Autocity Services Private Limited; in (a) connection with the Kolkata Shareholders Agreement, or (b) relation to Autocity Services Private Limited's interests in LCEPL.

## **36. BOARD MEETINGS**

- 36.1 Meetings of the Board shall be properly convened and held either in Mumbai or Ahmedabad (provided that the Board shall meet at least once in every Quarter) unless another venue is agreed to by the unanimous consent of the Board. Any Director may request that a meeting of the Board be convened.
- 36.2 No meeting of the Board shall be convened on less than 15 (fifteen) days' notice without the consent of 1 (one) Investor Director, provided that an Investor Director may waive such prior notice by providing a written consent to hold the relevant Board meeting at shorter notice.
- 36.3 Each notice of meeting of the Board must contain a detailed agenda of items (and all other relevant documentation) proposed to be considered at the meeting of the Board. The business conducted at any meeting of the Board shall only comprise those matters expressly stated in the notice convening such meeting unless otherwise agreed by nominee Director of Sponsor 1 and the Investor.
- 36.4 Subject to the provisions of Article 36.5, the valid quorum for any meeting of the Board shall be at least 2 (two) Directors or one-third of the then sanctioned strength of the Board, whichever is higher, comprising at least 1 (one) Investor Director (unless specifically waived in writing by an Investor Director) and 1 (one) Director nominated by Sponsor 1. Such quorum would have to be maintained continually throughout such meeting of the Board.
- 36.5 If at least 1 (one) Investor Director is not present within 1 (one) hour of the time appointed for a meeting or ceases to be present at any time during the meeting, the meeting shall stand adjourned to the same place and time 7 (seven) days after the original date set for such meeting of the Board. If at the adjourned meeting, at least 1 (one) Investor Director is not present within 1 (one) hour of the time appointed for the meeting, the meeting shall stand adjourned to the same place and time 7 (seven) days after the date set for such adjourned meeting of the Board. If at the second adjourned meeting, at least 1 (one) Investor Director is not present within 1 (one) hour of the time appointed for the meeting, the Directors present shall constitute a quorum and all matters (except Reserved Matters) may be resolved during such second adjourned meeting, provided the notice of the original meeting was issued in accordance with Articles 36.2 and 36.3. For the avoidance of doubt, the agenda of the adjourned meetings shall remain unchanged and shall be limited to only those matters expressly stated in the notice convening the original meeting unless otherwise agreed by 1 (one) Investor Director.
- 36.6 If a quorum is not present in the second adjourned meeting described in Article 36.5, a Reserved Matter on the agenda of such adjourned meeting shall be resolved by the following process:
- 36.6.1 the Company shall provide the Investor with a written notice requesting for their opinion on such Reserved Matter;

36.6.2 the Investor shall provide its decision on such Reserved Matter within a period of 10 (ten) Business Days from the date of receipt of the written notice set out in Article 36.6.1, provided that, such time period shall be extended by the time taken by the Company to provide the Investor with any additional information in relation to the Reserved Matter (as may be requested by the Investor); and

36.6.3 if the Investor does not provide its decision in the manner set out in Article 36.6.2 above, the relevant Group Company shall be free to proceed with the Reserved Matter in the manner set out in the agenda notice (issued in accordance with Article 36.3).

36.7 In the event that it is so permitted by applicable law, any Director may participate in a Board meeting by means of a telephone or video conference by means of which all persons participating in the meeting can hear each other throughout the duration of the meeting, and participation in such Board meeting by such means shall constitute attendance for the purposes of quorum and presence in person at the meeting of the Director so participating.

### **37. ROLE OF THE INVESTOR DIRECTORS / NON-EXECUTIVE DIRECTORS**

37.1 The Parties expressly agree that the Investor Directors shall be non-executive Directors.

37.2 The Sponsors and the Company expressly agree and undertake that the Investor Directors and any other non-executive Directors (including for the avoidance of doubt, Directors who are not in the whole time or part time employment of the Group Companies) (together, the “**Non- Executive Directors**”) shall not be in charge of, or responsible for the day to day management of the Company and shall not be deemed to be or considered or identified as the “responsible officer”, the “authorised officer”, the “compliance officer”, the “officer having knowledge”, the “officer in charge”, “officer in default” or “an employer of the employees” for the purposes of various statutory and regulatory compliances and applicable laws, including any compliances under labour law, environmental laws and the Companies Act, and shall accordingly not be liable for any default or failure of the Company in complying with the provisions of any applicable laws.

37.3 Further, the Sponsors and the Company undertake to endeavour that the other Directors or suitable persons are nominated as the “responsible officer”, the “authorised officer”, the “compliance officer”, the “officer having knowledge”, the “officer in charge”, “officer in default” or “an employer of the employees” for the purposes of various statutory and regulatory compliances and applicable laws, including any compliances under labour law, environmental laws and the Companies Act, failing which all the Directors nominated for appointment by the Sponsors shall be considered as the “responsible officer”, the “authorised officer”, the “compliance officer”, the “officer having knowledge”, the “officer in charge”, “officer in default” or “an employer of the employees” for the purposes of various statutory and regulatory compliances and applicable laws.

### **38. CHAIRMAN**

The Chairman shall be elected by the Board from one of the Directors nominated for appointment by the Sponsors. The Chairman is not liable to retire by rotation, except in order to comply with Applicable Law. The Chairman at the Effective Date will be Sponsor 1. The Chairman shall not have a second or casting vote.

### **39. COMMITTEES OF THE BOARD**

39.1 The Board shall have the power to constitute, if necessary, committees or sub committees of the Board and delegate such of the Board’s powers to such committees as the Board may deem fit.

39.2 At least 1 (one) Investor Director shall always be a member of each committee or sub- committee constituted by the Board.

39.3 Unless agreed in writing by the Parties or otherwise permitted under these Articles, all provisions of these Articles relating to the Board and its meetings shall be applicable to the committees mentioned in this Article 39 and the meetings thereof.

### **39A Accounts and MIS Reports**

The Group Companies shall (and the Sponsors and the Company shall procure that each Group Company shall), prepare and deliver to the Investor and each Investor Director:

- 39A.1 within 10 (ten) days of the first day of each month, internal management reports on the business activities and performance of each Group Company made up to and as at the end of the previous month (which shall include such additional information as is reasonably required by the Investor and notified to the Board or the management team of the Company);
- 39A.2 within 30 (thirty) days of the first day of each Quarter, unaudited financial statements (including a provisional unaudited balance sheet, income statement and statement of cash flows) of each Group Company made up to and as at the end of the previous Quarter (which shall include such additional information as is reasonably required by the Investor and notified to the Board or the management team in writing, including (i) notes on any significant operational issues; and (ii) a summary of the progress against the relevant Annual Business Plan and Budget covering items including (A) actual financial results versus the forecasted financial results; (B) actual capital expenditure versus forecasted capital expenditure; and (C) progress against business development targets and each Group Company's compliance with the relevant Annual Business Plan and Budget);
- 39A.3 promptly after the occurrence of any material acquisition, disposition or restructuring or any key management persons changes of the Group Companies, or the commencement of any material suit, claim, action or investigation involving the Group Companies, a report containing a description of such event; and
- 39A.4 within 90 (ninety) days of the end of a Financial Year to which they relate, annual audited accounts of each Group Company (including (i) an audited balance sheet, income statement and statement of cash flows; and (ii) details of the Audited PAT for the relevant Financial Year).

### **39B Circular Resolution**

A circular resolution in writing (including any resolution on any Reserved Matter passed in accordance with the provisions of these Articles and the Shareholders Agreement), executed by or on behalf of a majority of the Directors (but subject to the provisions of the Articles and the Shareholders Agreement), shall constitute a valid decision of the Board provided that a draft of such resolution was sent to all of the Directors at their usual address together with a copy of all supporting papers.

## **40. SHAREHOLDER MEETINGS**

### *MEETINGS*

- 40.1 Meetings of the Shareholders shall be in accordance with the Companies Act and the Articles and shall be held at the registered office of the Company during normal business hours. The Board shall provide the Company's previous Financial Year's audited financial statements to all Shareholders at least 1 (one) month before the annual general meeting is held to approve and adopt the audited financial statements.
- 40.2 No meeting of the Shareholders shall be convened on less than 21 (twenty-one) days' notice, provided that meetings of the Shareholders may be convened at shorter notice in accordance with the provisions of the Companies Act and these Articles.
- 40.3 Each notice of meeting of the Shareholders must contain a detailed agenda of items (and all other relevant documentation) proposed to be considered at the meeting of the Shareholders. The business conducted at any meeting of the Shareholders shall only comprise those matters expressly stated in the notice convening such meeting unless otherwise agreed in writing by the Investor and Sponsors.
- 40.4 In order to constitute a valid quorum at any meeting of the Shareholders, (i) a duly authorised representative of the Investor; and (ii) Sponsor 1 will be required to be present.
- 40.5 If at least 1 (one) duly authorised representative of the Investor is not present within 1 (one) hour of the time appointed for a meeting or ceases to be present at any time during the meeting, the meeting shall stand adjourned to the same place and time 7 (seven) days after the original date set for such meeting of the Shareholders. At the adjourned meeting, the Shareholders present shall constitute a quorum and all matters (except Reserved Matters) may be resolved during such adjourned meeting, provided the notice of the original meeting was issued in accordance with Articles 40.2 and 40.3. For the avoidance of doubt, the agenda of the adjourned meeting shall

remain unchanged and shall be limited to only those matters expressly stated in the notice convening the original meeting unless otherwise agreed by a duly authorised representative of the Investor and the Sponsors.

40.6 If a quorum is not present in the adjourned meeting described in Article 40.5, a Reserved Matter on the agenda of such adjourned meeting shall be resolved by the following process:

40.6.1 the Company shall provide the Investor with a written notice requesting for their opinion on such Reserved Matter;

40.6.2 the Investor shall provide its decision on such Reserved Matter within a period of 10 (ten) Business Days from the date of receipt of the written notice set out in Article 40.6.1, provided that, such time period shall be extended by the time taken by the Company to provide the Investor with any additional information in relation to the Reserved Matter (as may be requested by the Investor).

40.6.3 if the Investor does not provide its decision in the manner set out in Article 40.6.2 above, the relevant Group Company shall be free to proceed with the Reserved Matter in the manner set out in the agenda notice (issued in accordance with Article 40.3).

40.7 **Chairman:** The Chairman of the Board shall be the chairman of meetings of the Shareholders. In the event the Chairman is absent or fails to serve as a presiding officer at any meeting of the Shareholders, any one of the Directors nominated by the Sponsors shall be elected to preside in his or her place. The Chairman shall not have a casting vote.

#### 41. BOARD AND SHAREHOLDERS' VOTING

41.1 Majority Approval and Voting on a Fully Diluted Basis: At, (i) a meeting of the Board, matters shall be approved by a simple majority of the Directors present; and; (ii) a meeting of the Shareholders of the Company, matters shall be approved by a simple majority of Shareholders present, or by such other majority approval level required by applicable law. For the avoidance of doubt, the Investor shall be entitled to exercise its voting rights at any meeting of the Shareholders of the Company on a fully diluted basis. Subject to applicable law, the CCPS held by the Investor shall carry voting rights equal to the shareholding percentage of the Investor computed on an as-if-converted basis.

41.2<sup>8</sup> Affirmative rights of the Investor:

Notwithstanding anything to the contrary contained in this Agreement, the Sponsors and the Group Companies shall procure that no action or decision is taken by any Group Company in relation to any of the following matters (the "**Reserved Matters**") without the prior approval in writing of the Investor:

- (a) borrowing money or incurring any indebtedness, including providing any guarantees or indemnities in excess of the thresholds permissible under the Companies Act;
- (b) issuing, allotting, redeeming or repurchasing any Shares or debt securities, including, without limitation, issuing any bonus shares, of any Group Company;
- (c) amending, or waiving any provision of the Articles of Association or the Memorandum of Association or changing the rights of any class of Shares;
- (d) any Group Company entering into or effecting any amalgamation, demerger, merger, consolidation, re-organisation or corporate restructuring, or any Group Company changing its legal entity type (including its status from a private company to a public company);
- (e) causing any Group Company to: (i) undertake any acquisition of a Third Party or investment in a Third Party (including acquisition of shares); or (ii) form any joint-ventures or partnership with any Person;
- (f) incorporating any Subsidiary or other body corporate;
- (g) effecting a public offering of any securities of any Group Company, or listing or delisting any securities of any Group Company on or from any stock exchange (including taking any steps to initiate any of the foregoing actions e.g., appointment of advisors / merchant bankers to assist with a public offering);
- (h) incurring any capital expenditure in a Financial Year in excess of INR 450,000,000 (Indian Rupees Four Hundred Fifty Million only);
- (i) effecting any change in Group Company's accounting policies which are not on account of any changes in the applicable laws;

---

<sup>8</sup> Article 41.2 has been amended by Members of the Company by passing a special resolution at 12th Annual General Meeting held on 26th September 2018

- (j) appointing or removing the auditors of a Group Company;
- (k) transferring any material asset of any Group Company (for purposes of this Clause 41.2 (k), “material asset” shall mean: (i) assets, individually or in the aggregate, having a book value or market value of INR 50,000,000 (Indian Rupees Fifty million); (ii) Intellectual Property; (iii) any interests (including the right to use) in a real property; and/or (iv) any shares of a Group Company);
- (l) proposing or taking any steps to wind up a Group Company, filing of a petition for winding-up by a Group Company, making of any arrangement by a Group Company with creditors generally or any application for an administration order or for the appointment of a receiver or administrator in respect of a Group Company;
- (m) causing or permitting any Group Company to enter into, amend or terminate any arrangements or transactions with any related party other than those entered into in the ordinary course of business and which are on arms’ length basis. For the avoidance of doubt, this Clause 41.2 (m) does not apply to any arrangements or transactions which are undertaken solely between the Group Companies;
- (n) entering into, modifying or terminating any material contract or arrangement or any contract affecting a material part of the Business, which is: (i) outside the ordinary course of business; (ii) is intended to persist for longer than 12 (twelve) months; (iii) contains any unusual or onerous commitment(s); or (iv) could involve liability to make payments in excess of INR 20,000,000 (Indian Rupees Twenty million);
- (o) causing any Group Company to: (i) commence any case, proceeding or other action: (A) under any bankruptcy, insolvency or similar law seeking to have an order of relief entered with respect to it or seeking to adjudicate it as bankrupt or insolvent, or seeking reorganisation, arrangement, adjustment, winding up, liquidation, dissolution, composition or other relief with respect to it or its debts; or (B) seeking appointment of a receiver, trustee, custodian or other similar official for it or all or any substantial part of its property; (ii) make a general assignment for the benefit of its creditors; and/or (iii) admit in writing its inability to pay its debts when they become due;
- (p) entering into any arrangement, agreement or commitment in relation to any of the matters listed in (a) to (o) above.

41.3 Manner of Approving Reserved Matters: Subject to Article 36.6.3 and Article 40.6.3, any resolution to be passed in relation to a Reserved Matter shall be deemed to have been passed or approved only if both the Investor and the Sponsor 1 have voted in favour of that resolution or given its written consent in favour of such matter. The Investor shall be entitled to grant or refuse its affirmative consent (whether in a meeting of the Shareholders or otherwise) in respect of any Reserved Matter, at its sole and absolute discretion. Any such consent or refusal by the Investor and Sponsor 1 shall stand final and the Company shall carry out its business and operations in accordance with such decision(s) and to the extent permitted pursuant to such decision(s).

41.4<sup>9</sup> To borrow or raise money with or without security or to receive money on deposit at interest or otherwise, in such a manner as the Board or Shareholders of the Company may think fit and in security of any such moneys to be borrowed, raised or received, to mortgage, pledge or charge the whole or any part of the property, assets or revenue of the Company present or future, including its uncalled capital and to purchase, redeem or pay off any such securities.

## THE BUSINESS

### 42. NATURE OF BUSINESS

42.1 The Parties agree, and each of the Sponsors shall procure, that the business of the Group Companies shall be to undertake: (a) the operation of showrooms to buy and sell automobiles (whether new or used) of a single brand i.e. “Mercedes Benz”; (b) the operation of workshops and garages to repair and service automobiles; (c) automobile financing activities; (d) insurance commission business in connection with (a) and (b) above; and/or (e) such other businesses as may be approved by the Investor in accordance with Article 41.2 (each such business referred to as the “**Business**”).

42.2 The Investor and the Sponsors agree that the Business of the Group Companies shall be conducted in accordance with the provisions of these Articles and each of the Sponsors agree to exercise its respective rights as a Shareholder in the Company to ensure that the Company (and each Group Company) complies in all respects with its respective memorandum of association and articles of association and all applicable laws.

42.3 Each of the Shareholders agrees that it shall (i) comply in all respects with, and (ii) exercise its respective rights as a Shareholder in the Company to ensure that the Company (and each Group Company) complies in all respects

<sup>9</sup> Article 41.4 has been inserted vide passing special resolution at an Extra-Ordinary General of Members held on 10<sup>th</sup> November, 2021.

with, the terms of the Transaction Documents.

#### **43. ABILITY OF THE SPONSORS TO ENGAGE IN OTHER BUSINESSES**

- 43.1 The Sponsors covenant and agree that they shall not, and shall procure that none of their Affiliates shall, during the Restricted Period, engage in any Restricted Activities in India without the prior written consent of the Investor.
- 43.2 Sponsor 1 also covenants and undertakes to (a) devote a substantial portion of his time to the operations and functioning of the Business of the Group; (b) at all times work in the best interests of the Group, including by transacting the Business only through the Group, and not do any act, deed or thing that may defeat this responsibility; and (c) not do any act, deed or thing that restricts or disables the Investor from enforcing its respective rights.
- 43.3 The undertakings in Article 43.1 are given by each Sponsor to the Investor and to the Company and applies to actions carried out by the Sponsors in any capacity and whether directly or indirectly on their behalf, on behalf of any other Person or jointly with any other Person.
- 43.4 The undertakings in Article 43.1 are given by Sponsor 1 to the Investor and to the Company and applies to actions carried out by the Sponsor 1 in any capacity and whether directly or indirectly on their behalf, on behalf of any other Person or jointly with any other Person.
- 43.5 Each of the covenants in Articles 43.1, 43.2 and 43.3 is considered fair and reasonable by each Sponsor and is agreed by the Sponsors to be necessary for the protection of the Investor, the Company and the goodwill of the Company.
- 43.6 Each Sponsor covenants that (i) by entering into the covenants of non-competition contained in these Articles, the livelihood of the Sponsors and their Affiliates is not impaired; and (ii) they have agreed to the covenants in this Article 43 in consideration of the investment in the Company and its goodwill by the Investor.
- 43.7 If any of the restrictions contained in this Article 43 is found to be unenforceable but would be valid if any part of it were deleted or the period or area of application amended, the restriction shall apply with such minimal modifications as may be necessary to make it valid and effective.

#### **44. CERTAIN NEW BUSINESSES TO BE UNDERTAKEN BY THE SPONSORS**

- 44.1 The Sponsors and their Affiliates shall be permitted to undertake the following business activities on terms and conditions as may be agreed in writing between the Investor and the Sponsors from time to time:
- 44.1.1. retail sales of multi-brand used automobiles; and
- 44.1.2. retail sales of multi-brand automobile accessories.
- 44.2 Business activities undertaken by any Sponsor and/or its Affiliates in accordance with the provisions of Article 44.1 shall (a) not be considered to be in breach of their obligations under Article 43; and (b) be undertaken through a Person which is not a Group Company.
- 44.3 Without prejudice to the provisions of Article 43:
- 44.3.1. in the event the Sponsors and/or their Affiliates wish to directly or indirectly invest or engage in (a) a business involving sale, service or repair of automobiles of a brand other than Mercedes Benz, Volkswagen, Ashok Leyland and Honda; and/or (ii) another automobile related business (each such business, the “**New Business**”), the Sponsors shall, and will procure that their Affiliates shall, endeavour to commence such New Business with the Investor (or Affiliates of the Investor) on mutually acceptable terms and conditions (which in any event shall be no less favourable than the terms on which the Investor has invested in the Company) by giving the Investor written notice of such intention. The Sponsors shall, and will procure that their Affiliates shall, provide the Investor with all such information which is reasonably required by the Investor to make an informed assessment of the New Business; and
- 44.3.2. on receipt written notice from the Sponsors and related information in accordance with Article 44.3,

the Investor shall within a reasonable time period inform the Sponsors in writing of whether it wishes to participate in the New Business or whether it wishes to decline the opportunity to participate in the New Business. Should the Investor wish to participate in the New Business, the Sponsors and the Investor shall act in good faith to (i) finalize the commercial terms of the Investor's participation in the New Business, and (ii) facilitate the New Business. Should the Investor decline to participate in the New Business, the Sponsors and/or its Affiliates shall be free to pursue such New Business either directly or with a Third Party. As a general principle, the amounts to be invested by the Investor in the New Business (as per the funding requirements and agreed business plan of the New Business) will (x) be proportionate to its then existing shareholding percentage (on a fully diluted basis) in the Company; and (y) be subject to the approval of the investment committee of the Investor.

44.3.3. The New Business undertaken by the Sponsors and/or their Affiliates in accordance with Article 44.3 shall not be considered to be in breach of Article 43.

#### **45. SPONSOR REPRESENTATIONS**

Each time information is made available to the Investor and/or the Valuer (as the case may be) pursuant to these Articles or otherwise, the Sponsors represent and warrant that revenue calculations as provided in the accounts of the Group Companies have not been artificially adjusted, manipulated or extrapolated in any manner whatsoever.

#### **46. OTHER INFORMATION**

Each Group Company shall furnish or cause to be furnished to the Investor (and the Sponsors and the Company shall procure that the relevant Group Company shall furnish or cause to be furnished to the Investor), within 15 (fifteen) days of request of the Investor such further information about the business, financial conditions, operations, results and prospects of any of the Group Companies.

#### **47. ANNUAL BUDGET**

The Company shall prepare a proposed Annual Business Plan and Budget, which shall be submitted every Financial Year to the Investor / Investor Directors, within 15 (fifteen) days of Mercedes-Benz India Private Limited providing its business plan to the Company. Subject to the Parties being satisfied with the proposed Annual Business Plan and Budget, the Board shall adopt the Annual Business Plan and Budget. Each Group Company shall operate and conduct its affairs in accordance with the Annual Business Plan and Budget.

#### **48. INDEMNIFICATION UNDER THE SHAREHOLDERS AGREEMENT**

48.1 The Sponsors ("**Indemnifying Party**") hereby irrevocably and unconditionally agree to indemnify and hold the Investor, the Group Companies, the directors of the Group Companies nominated by the Investor, the Investor's Affiliates and any of their respective officers or employees (not including any legal and/or accounting service providers retained by the Investor) (together, the "**Indemnified Parties**") harmless, on demand, from and against any and all Losses as a result of any misrepresentation or material breach of any representation or warranty made by an Indemnifying Party under the Shareholders Agreement or non-fulfilment of or failure to perform any covenant or agreement contained in the Shareholders Agreement by the Indemnifying Party.

48.2 The rights of indemnification of the Investor hereunder shall be in addition to all other rights available to it in law, equity or otherwise, including without limitation rights of specific performance and rescission. In relation to any dispute under the Shareholders Agreement for which the Investor has elected for indemnification (amongst its other rights) and its claim has been fully satisfied by the Sponsors, the Investor shall not invoke any other rights against the Sponsors under the Shareholders Agreement.

48.3 In respect of any matter in relation to which the Indemnified Parties are entitled to be indemnified by the Sponsors, the Sponsors agree and acknowledge that the Indemnified Parties shall be entitled, at their option, to proceed against any or all of the Sponsors and the Sponsors shall be jointly and severally liable in this regard.

48.4 The Company and each Group Company shall indemnify its directors to the fullest extent permissible under law, including against any and all Losses and expenses which such directors may incur arising out of or in connection with (i) any proceeding that any such director becomes a party to or is involved in as a result of being a director of the Group Company, (ii) any material breach of agreement, wilful omission or misconduct of or by the Group Company or their employees or agents, or (iii) any action, suit, claim or proceeding arising



out of or relating to any such conduct, or any action or failure to act undertaken by such director at the request of the Group Company, or contravention of any law in respect of the business of the Group Company, and any action or proceedings taken against a director in connection with any such contravention or alleged contravention, except where such liabilities arise solely due to gross negligence of such director or any criminal offence committed by such director (for which such director has been convicted).

- 48.5 To the extent the payment by Indemnifying Party, of any indemnification payment pursuant to the provisions of the Shareholders Agreement (“**Indemnity Amount**”) is made or to be made outside India, the Parties making the payment shall be responsible for obtaining all necessary approvals / consents from the relevant Governmental Authorities and the other Parties shall cooperate to make all applications and take all steps required to obtain the same.
- 48.6 The payment of the Indemnity Amount by the Indemnifying Party in accordance with the provisions of the Shareholders Agreement shall be made to the Indemnified Party after deducting therefrom, any deduction or withholding for or on account of any Taxes, if required to be made under applicable law. If the Indemnifying Party is required to deduct any Taxes as aforesaid, the Indemnity Amount paid to the Indemnified Party shall be net of such deduction. Within 30 (thirty) days of making either a deduction or withholding for or on account of any Taxes, the Indemnifying Party shall deliver to the Indemnified Party evidence that such deduction or withholding has been made (if applicable) or any other appropriate payment (if applicable) has been made to the relevant Governmental Authority.
- 48.7 The Indemnified Parties shall have the right to nominate any Person for the purpose of receiving the amounts payable by the Indemnifying Parties pursuant to this Article 48.

#### **48A Indemnification under the Share Subscription and Purchase Agreement**

The Warrantors will, on a joint and several basis, indemnify, defend and hold harmless each of the relevant Persons as specified under the Share Subscription and Purchase Agreement, pursuant to the indemnity obligations of the Warrantors under the Share Subscription and Purchase Agreement, in the manner provided therein.

### **49. CONFIDENTIALITY**

#### *NO DISCLOSURE BY PARTIES*

The Parties on behalf of themselves and their respective Affiliates, advisors and officers (collectively, “**Recipient**”), agree with each other and their respective Affiliates, advisors and officers to ensure that (i) all information received or accessed by it or disclosed to it in relation to a Party and the business of the Group Companies including information relating to present and future products, services, business plans and strategies, marketing ideas and concepts, bids to be submitted, present and future product plans, pricing, volume estimates, financial data, marketing plans, sales strategies, customer information customer requirements, designs, plans, apparatus, data or other technical and business information, and (ii) the contents of the Transaction Documents, which in each case is confidential, proprietary and/or not otherwise generally available in the public domain (such information collectively, “**Confidential Information**”) shall be kept confidential and shall not be revealed (except in accordance with Article 50). Further, each Recipient shall employ such care as Recipient employs with respect to its own proprietary and confidential information and will not use and will cause its Affiliates, advisors and officers not to use such Confidential Information for any purpose other than the performance of its obligations under the Transaction Documents.

### **50. PERMITTED DISCLOSURE**

- 50.1 No Party shall, without the prior written consent of each of the other Parties, disclose any Confidential Information except:
- 50.1.1 to the extent necessary to comply with any laws or regulations binding on it, in which case such Party shall give at least 3 (three) day written notice of such disclosure of Confidential Information;
- 50.1.2 to the extent necessary to comply with any requirements of any stock exchange or other regulatory body, in which case such Party shall give at least 1 (one) day written notice of such disclosure of Confidential Information;

- 50.1.3 any Shareholder may disclose any information in relation to the Company to a potential purchaser of Shares of the Company (whether direct or indirect), provided that the Shareholder shall obtain appropriate undertakings of confidentiality from any such potential purchaser;
- 50.1.4 to the extent related to the tax treatment and tax structure of the transactions contemplated by the Shareholders Agreement (including all materials of any kind, such as opinions or other tax analyses that the Company, its Affiliates or its representatives have provided to such shareholder relating to such tax treatment and tax structure); provided that the foregoing does not constitute an authorization to disclose the identity of any existing or future party to the transactions contemplated by the Shareholders Agreement and/ or these Articles or their Affiliates or representatives, or, except to the extent relating to such tax structure or tax treatment, any specific pricing terms or commercial or financial information;
- 50.1.5 to the extent any disclosure is required to be made to an upstream direct or indirect stakeholder of the Investor and/or its Affiliates under applicable laws, or to the limited partners of any Affiliates of the Investor, provided that the disclosing party shall notify such Persons of the confidential nature of such information;
- 50.1.6 in relation to a joint press announcement, the contents of which have previously been agreed by the Shareholders; or
- 50.1.7 to the professional advisers and key employees of each of the Parties who need to know such details.

## **51. PERIOD OF NON-DISCLOSURE**

Articles 49 to 52 shall survive the termination of the Shareholders Agreement without limit in time, provided that these Articles 49 to 52 shall no longer apply to Confidential Information that comes into the public domain other than as a result of a breach by (i) a Party of the provisions contained in Articles 49 to 52; and (ii) a third party to whom a permitted disclosure was made.

## **52. NO USE OF INVESTOR NAME**

None of the Group Companies or Sponsors may in any way use the Investor's name or mark or the name or mark of the Investor's Affiliates or any derivative thereof in any public disclosure, including any press release, without prior written approval from the Investor.

## **53. ENFORCEMENT OF COMPANY'S RIGHTS**

Any right of action which a Group Company may have in respect of any breach of any obligation owed by a Shareholder (or Affiliate of the Shareholder) to the Company shall be prosecuted by the Directors of the Company appointed by the Shareholder(s) which is not, or whose Affiliate is not, responsible for the breach provided an opportunity is provided to remedy such breach. Those Directors shall have full authority on behalf of the Company to negotiate, litigate and settle any claim arising out of the breach or purported breach or exercise any right of termination arising out of the breach and the Shareholders shall take all steps within their power to give effect to the provisions of this Article 53.

## **54. GENERAL**

### **54.1 Variation to be in Writing**

No variation of these Articles and / or Memorandum shall be effective unless in writing and signed by or on behalf of the Parties, in which case the Articles and/or Memorandum, as the case may be, shall be amended as appropriate and subject to the Shareholder's approval to reflect any such agreed variation.

### **54.2 No Waiver**

54.2.1 No waiver of any right under these Articles shall be effective unless in writing. Unless expressly stated otherwise a waiver shall be effective only in the circumstances for which it is given.

- 54.2.2 No delay or omission by any Party in exercising any right or remedy provided by law or under these Articles shall constitute a waiver of such right or remedy.
- 54.2.3 The single or partial exercise of a right or remedy under these Articles shall not preclude any other nor restrict any further exercise of any such right or remedy.
- 54.2.4 The rights and remedies provided in these Articles are cumulative and do not exclude any rights or remedies provided by law.
- 54.2.5 Without prejudice to any other rights or remedies that the Parties may have, the Parties acknowledge and agree that damages would not be an adequate remedy for any breach of Article 49 (Confidentiality) and that the remedies of injunction, specific performance and other equitable remedies are appropriate for any threatened or actual breach of such Article.

### **54.3 Severance and Validity**

- 54.3.1 If any one or more of the provisions contained in these Articles shall for any reason be held to be **invalid, illegal or unenforceable in any respect under the laws of any jurisdiction, then such invalidity, illegality or unenforceability** shall not affect:
- (a) any other provision of these Articles, and the Shareholders Agreement shall be construed under the applicable law of such jurisdiction as if such invalid, illegal or unenforceable provision had never been set forth herein, and shall be carried out as nearly as possible according to its original terms and intent; and
  - (b) the validity, legality and enforceability of such provisions under the applicable law of any other jurisdiction.
- 54.3.2 The Parties shall endeavour to replace any such invalid, illegal or unenforceable provision with a valid, legal and enforceable provision which as far as possible reflects the original intent of the Parties.

### **55. ENTIRE AGREEMENT**

The Shareholders Agreement, together with each of the other Transaction Documents and any other documents referred to in the Shareholders Agreement or any Transaction Document, constitutes the whole agreement between the Parties and supersedes any previous arrangements or agreements between them relating to the Shares and the management of the Company (including but not limited to the term sheet dated 15 April 2014).

Nothing in this Article 55 shall have the effect of limiting or restricting any liability arising as a result of any fraud, wilful misconduct or wilful concealment.

### **56. ASSIGNMENT**

Except as provided elsewhere in the Shareholders Agreement and/ or these Articles, no Party shall assign or create any trust in respect of, or purport to assign or create any trust in respect of, any of its rights or obligations under the Shareholders Agreement and / or these Articles without the prior written consent of the other Parties.

### **57. FURTHER ASSURANCE**

Each of the Parties shall from time to time and at its own cost do, execute and deliver or procure to be done, executed and delivered all such further acts, documents and things required to give full effect to the Shareholders Agreement and / or these Articles and their relevant rights, powers and remedies under the Shareholders Agreement and/ or these Articles.

### **58. INSPECTION**

Each of the Sponsors and the Company shall procure that upon the Investor giving the relevant Group Company prior notice of 15 (fifteen) days, the Investor and its representatives may, during normal Business Days and

hours and without disrupting the day to day operations of such Group Company, (a) inspect and examine and take copies of the Books and Records and accounts kept by each Group Company, (b) access the premises of the Group Companies, and (c) consult with and interview senior management personnel and other members of the management team of the Group Companies. The prior notice mentioned in this Article should contain in reasonable detail, the information / record / consultation sought by the Investor.

## **59. PROXY**

59.1 The instrument appointing a proxy and the power-of-attorney or other authority, if any, under which it is signed or a notarised copy of that power or authority, shall be deposited at the registered office of the company not less than 48 hours before the time for holding the meeting or adjourned meeting at which the person named in the instrument proposes to vote, or, in the case of a poll, not less than 24 hours before the time appointed for the taking of the poll; and in default the instrument of proxy shall not be treated as valid.

59.2 An instrument appointing a proxy shall be in the form as prescribed in the rules made under section 105 of the Companies Act.

59.3 A vote given in accordance with the terms of an instrument of proxy shall be valid, notwithstanding the previous death or insanity of the principal or the revocation of the proxy or of the authority under which the proxy was executed, or the transfer of the shares in respect of which the proxy is given:

Provided that no intimation in writing of such death, insanity, revocation or transfer shall have been received by the company at its office before the commencement of the meeting or adjourned meeting at which the proxy is used.

## **GOVERNING LAW; DISPUTE RESOLUTION**

### **60. GOVERNING LAW**

These Articles, including any non-contractual disputes arising thereunder, shall be governed by and construed in accordance with the laws of India.

### **61. DISPUTE RESOLUTION**

61.1 If any dispute, controversy or claim arises out of or in connection with these Articles, including any question regarding its existence, validity or termination (a Dispute) the Parties shall use all reasonable endeavours to resolve the matter amicably. If 1 #one) Party gives another Party notice that a Dispute has arisen and the Parties are unable to resolve the Dispute within 30 #thirty) days of service of the notice then the Dispute shall be referred for arbitration under Article 61.2.

61.2<sup>10</sup> A All Disputes, which are unresolved pursuant to Clause 61.1 and which a Party wishes to have resolved, shall be referred upon the application of any Party to and finally settled through arbitration under the rules of arbitration laid down by the London Court of International Arbitration #the "Rules"), which Rules are deemed to be incorporated by reference to this Article. The arbitration shall be conducted through an arbitral tribunal of 3 #three) arbitrators, with the claimants appointing 1 #one) arbitrator, the respondents appointing 1 #one) arbitrator and the arbitrators so appointed jointly appointing the third arbitrator, who will preside as chairman. No officer, director, shareholder, employee, representative or Relative of any Party may be nominated or appointed as an arbitrator. The seat of the arbitration shall be New Delhi, India. The language of this arbitration shall be English and any document not in English submitted by any Party shall be accompanied by an English translation. A written transcript of the proceedings shall be made and furnished to the Parties.

61.3 The arbitral tribunal shall have the power to grant any legal or equitable remedy or relief available under law, including injunctive relief #whether interim and/or final) and specific performance and any measures ordered by the arbitral tribunal may be specifically enforced by any court of competent jurisdiction.

61.4 The Parties shall equally share the costs of the arbitral tribunal's fees, but shall bear the costs of their own legal counsel engaged for the purposes of the arbitration, subject to the provisions of Article 61.8.

---

<sup>10</sup> Article 61.2 has been amended by Members of the Company by passing a special resolution at 12th Annual General Meeting held on 26th September 2018

- 61.5 Any award of the arbitral tribunal pursuant to this Article 61 shall be in writing and shall be final, conclusive and binding upon the Parties, and the Parties shall be entitled #but not obliged) to enter judgment thereon in any one or more of the highest courts having jurisdiction.
- 61.6 During the course of any arbitration under this Article 61 except for the matters under dispute, the Parties shall continue to exercise their remaining respective rights and fulfil their remaining respective obligations under the Shareholders Agreement and/ or these Articles to the extent they are not related to the dispute.
- 61.7 Each Party shall participate in good faith to reasonably expedite (to the extent practicable) the conduct of any arbitral proceedings commenced under these Articles.
- 61.8 The arbitral tribunal shall decide on and apportion the costs and reasonable expenses (including reasonable fees of counsel retained by the Parties) incurred in the arbitration.
- 61.9 The arbitral tribunal shall also have the power to decide on any dispute regarding the validity of this Article 61. Notwithstanding anything contained in the Rules, in order to facilitate the comprehensive resolution of related disputes, and upon request of any Party to the arbitration proceeding, the arbitral tribunal may, within 90 (ninety) days of its appointment, consolidate the arbitration proceeding with any other arbitration proceeding involving any of the Parties relating to these Articles and/ or the Shareholders Agreement. The arbitral tribunal shall not consolidate such arbitrations unless it determines that (a) there are issues of fact or law common to the proceedings, so that a consolidated proceeding would be more efficient than separate proceedings; and (b) no Party would be prejudiced as a result of such consolidation through undue delay or otherwise.

**62. MANAGING DIRECTOR, CHIEF EXECUTIVE OFFICER, MANAGER, COMPANY SECRETARY OR CHIEF FINANCIAL OFFICER:**

62.1 Subject to the provisions of the Companies Act:

- (i) A Managing Director, a Chief Executive Officer, Manager, Company Secretary or Chief Financial Officer may be appointed by the Board for such terms at such remuneration and upon such conditions as it may think fit; and any Chief Executive Officer, Manager, Company Secretary or Chief Financial Officer so appointed may be removed by the Board;
- (ii) A Director may be appointed as Managing Director, Chief Executive Officer, Manager, Company Secretary or Chief Financial Officer.

**63. THE SEAL**

63.1 The Board shall provide for the safe custody of the Seal.

63.2 Every deed or other instrument, to which the Seal of the Company is required to be affixed shall unless the same is executed by a duly constituted attorney, be signed by two Directors or one Director and Secretary or some other person appointed by the Board for the purpose provided that in respect of the share certificate the Seal shall be affixed in accordance with these Articles.

**64. DIVIDENDS AND RESERVE**

64.1 The Board shall ensure that the Company at all times has the financial means necessary to implement the Business Plan i.e., to fund its growth and development according to the Business Plan. Profits available for distribution shall to such extent remain with the Company and shall not be distributed to the Shareholders.

64.2 Any profits available in excess, i.e., distributable profits available after utilization of funds for implementing the Business Plan and creation of appropriate reserves for any future funding requirements as foreseen in the Business Plan shall be distributed to the Shareholders pro rata to their shareholding in the Company in a manner agreed by the Parties.

64.3 The general meeting of the Company shall after respective recommendation by the Board decide on the distribution of profits and the Shareholders shall exercise their vote accordingly.

- 64.4 The Shareholders will give effectual receipts for any dividends, bonuses or other moneys payable in respect of such share.
- 64.5 Notice of any dividend that may have been declared shall be given to the persons entitled to share therein in the manner mentioned in the Companies Act.
- 64.6 No dividend shall bear interest against the Company.

## **65. WINDING UP**

In a winding up the liquidators may, with the sanction of a special resolution, distribute all or any of the assets of the Company in specie among the Shareholders in accordance with their respective rights.

66. *[INTENTIONALLY LEFT BLANK]*

67. *[INTENTIONALLY LEFT BLANK]*

68. *[INTENTIONALLY LEFT BLANK]*

## **69. OVERRIDING PROVISIONS**

- 69.1 If in the reasonable opinion of the Investor or Sponsor 1, any law or ruling requires that a specific provision of the Transaction Documents which is not expressly incorporated in these Articles be incorporated for the purposes of enforceability, such provision of the Transaction Document is deemed to be incorporated in these Articles, and the Shareholders shall take all required actions to incorporate such provision(s) into the Articles.
- 69.2 In the event of any conflict between Article 41.2 (*Affirmative Rights of the Investor*) and any other Article of these Articles of Association, Article 41.2 (*Affirmative Rights of Investors*) shall prevail.

## **70. NOTICES**

70.1 Any notice or other communication to be given under or in connection with this Article (“Notice”) shall be in the English language in writing and signed by or on behalf of the Party giving it and marked for the attention of the relevant Person. A Notice may be delivered personally or sent by facsimile or international courier to the address or facsimile number provided in Article 70.3.

70.2 A Notice shall be deemed to have been received:

70.2.1 at the time of delivery if delivered personally;

70.2.2 if sent by fax, at the time of receipt by the sending Party of an electronic confirmation of transmission of the notice to that addressee; or

70.2.3 5 (five) Business Days after the time and date of posting if sent by international courier,

Provided that, if receipt of any Notice occurs after 6.00 p.m. or is not on a Business Day, deemed receipt of the Notice shall be 9.00 a.m. on the next Business Day. References to time in this Article 70 are to local time in the country of the addressee. Pursuant to the despatch of the notice as under this Article 70.2, the Party sending the notice shall also email the contents of the entire notice to the receiving Party at the email addresses mentioned below.

70.3 The addresses, facsimile numbers and email addresses for service of Notice are as follows:

Representative (on behalf of the Sponsors):

Name : Mr Sanjay Thakker  
Address : Laxmi Nivas, 4th Floor, 22, Kashibai Navrange Marg, Gamdevi, Mumbai – 400 007  
Fax number : NA  
Email : sthakker@landmarkindia.net

To the attention of: Mr Sanjay Thakker

Company:

Name : Landmark Cars Private Limited  
Address : Landmark House, 3rd Floor, Near Gurudwara, Opp. AEC, Thaltej Cross Road, S G Highway, Ahmedabad 380059  
Fax number : NA  
Email : sthakker@landmarkindia.net

To the attention of : Mr Sanjay Thakker

Investor:

Name : TPG Growth II SF Pte. Ltd  
Address : 80, Raffles Place, #15-01 UOB Plaza, Singapore – 048624  
Email : mcoleman@tpg.com

To the attention of : Legal Department

**All Notices to the Investor will require simultaneous copies to be sent to:**

Name : TPG Growth  
Address : 345 California St., Suite 3300, San Francisco, CA 94104  
Fax number : 1 (415) 438-6869  
Email : mcoleman@tpg.com

To the attention of : Global General Counsel

- 70.4 A Party shall notify the other Parties of any change to its address in accordance with the provisions of this Article 70 provided that such notification shall only be effective on the later of the date specified in the notification and 5 (five) Business Days after deemed receipt.
- 70.5 Notice given to the Representative shall be deemed to be Notice to all of the Sponsors and the rights of the Sponsors in respect of such Notice shall be exercised or waived on behalf of them if exercised or waived by the Representative.
- 70.6 In the event that a Party refuses delivery or acceptance of a Notice, request or other communication, under these Articles, it shall be deemed that the Notice was given upon proof of the refused delivery, provided such Notice was sent in the manner specified in this Article 70.

**71. REPRESENTATIVE OF THE SPONSORS**

- 71.1 Sponsor 2 designates Mr Sanjay Thakker to serve as her representative (the “**Representative**”) with respect to the actions or decisions expressly identified in the Shareholders Agreement and / or these Articles and the other Transaction Documents to be performed or made by the Representative.
- 71.2 Sponsor 2 irrevocably appoints the Representative as her agent, proxy and attorney and gives the Representative full power and authority on such Party’s behalf to resolve or address all matters as are expressly contemplated by the Shareholders Agreement and / or these Articles and the other Transaction Documents.
- 71.3 Any action taken, or document executed by the Representative on behalf of Sponsor 2 in connection with the Shareholders Agreement and / or these Articles and the other Transaction Documents shall be deemed to have been made on behalf of such Party and the Investor shall be entitled to rely upon such action or document as being binding on such Party without further enquiry.

**72. RIGHTS OF THE PARTIES**

- 72.1 Notwithstanding anything to the contrary contained in the Shareholders Agreement and/ or these Articles, in the event any Party is unable to exercise any rights available to such Party under the Shareholders Agreement

and/ or these Articles (in part or in full) owing to any applicable law, then such Party shall be entitled to the exercise of any such right under the Shareholders Agreement and/ or these Articles to the limited extent permissible under law, provided that on the revocation, removal or diminution of such law or provisions, as the case may be, by virtue of which any right of such Party pursuant to the Shareholders Agreement and/ or these Articles was limited as provided hereinabove, the original provisions would stand renewed and be effective to their original extent, as if they had not been limited by the law or provisions revoked.

72.2 The Company and the Sponsors hereby acknowledge that the Investor and its Affiliates invest in numerous companies, some of which may compete with the Group Companies, and no claim shall be made nor shall the Investor and its Affiliates be liable for any claim arising out of, or based upon (i) the fact that it or its Affiliates hold an investment in any entity that competes with the Group Companies, (ii) developing a business relationship with any person involved in any business or company in the same or similar field as that of the businesses of the Group Companies, including any business or company deemed to be related to, or in competition with, the current businesses of the Group Companies; or (iii) any action taken by any of its officers or representatives to assist any such competitive company, whether or not such action was taken as a board member of such competitive company, or otherwise, and whether or not such action has a detrimental effect on any Group Company. To the fullest extent permitted by applicable law, the doctrine of corporate opportunity, or any other analogous doctrine, shall not apply with respect to the Investor.

### **73. CHANGE IN LAW**

73.1 If, due to any determination made by any Governmental Authority, a change in applicable law after the date hereof or any requirement of applicable law (in each case, in the sole opinion of the Investor), (i) any restriction is imposed on the Investor which makes it necessary for it to reduce all or some portion of its holding of the Shares held by it, or (ii) it becomes unlawful for the Investor to control or acquire any Shares that it is entitled to acquire these Articles or exercise any rights it is entitled to exercise under these Articles and / or the Shareholders Agreement, then the Investor shall have the right to nominate a Third Party to purchase all or some portion of the Shares held by it or to control or acquire any Shares that it is entitled to acquire or exercise any rights it is entitled to exercise under the these Articles and / or the Shareholders Agreement.

73.2 Where the Investor is subscribing to or purchasing any Shares pursuant to the Shareholders Agreement and/ or these Articles, in the event that the Investor is prevented from subscribing to or purchasing the Shares due to any applicable law or other stipulation of any Governmental Authority, it shall have the option of nominating any Third Party who shall be entitled to purchase or subscribe to such Shares. The Investor shall in such case be entitled to exercise the corresponding rights either by itself or through such Third Party.

### **74. DIVESTMENT RULING**

74.1 If there is any ruling, notification or any other decision of a Governmental Authority, which requires the Investor to decrease or divest its ownership in the Company (“**Divestment Ruling**”), then the Sponsors and the Company will, on a best effort basis, do or procure to be done all such further acts and things, execute or procure the execution of all such other documents and exercise all rights and powers, direct and indirect, available to it in relation to any Person so as to enable the Company and the Investor to comply with the Divestment Ruling in (i) a time-bound manner; and (ii) a manner which enables the Investor to at least receive the amounts originally invested by it in the Shares of the Company.

74.2 Upon the occurrence of any Divestment Ruling, if requested by the Investor:(a) the Company shall not, and the Sponsors shall procure that the Company shall not, utilize any balance CCPS Consideration (i.e. (i) any portion of the CCPS Consideration which as of the relevant date has not been deployed by the Company in accordance with the Annual Business Plan and Budget; and (ii) any available cash or cash equivalents with the Company for an amount of up to the CCPS Consideration) for any purpose other than as specifically permitted by the Investor in writing; and (b) the Company and the Sponsors shall exercise their best efforts to undertake all ancillary actions which may be required to give effect to Article 74.1 (which may include, amongst others, raising of external debt financing by the Company, conduct of an orderly sale process by an independent advisor).

74.3 Without prejudice to the generality of Article 74.1 and Article 74.2, the Company and the Sponsors shall do all reasonable acts and provide all such assistance reasonably requested by the Investor in order to obtain and maintain any Governmental Approvals or third-party approvals to (i) give effect to the provisions of Article 73, Article 74.1 and Article 74.2; and/or (ii) to mitigate the impact of any Divestment Ruling on the Investor. In



addition, the Company and the Sponsors shall, if requested by the Investor, cooperate with and assist the Investor in any discussions with such Governmental Authority, including in connection with any appeal process to such Divestment Ruling, and shall not, on behalf of the Company, enter into any settlement, undertaking, consent decree, stipulation or agreement with any Governmental Authority in connection with the transactions contemplated hereby or the Divestment Ruling, without the prior written consent of the Investor.

## 75. VALUATION OF SHARES

In the event that the valuation of the Shares is required to be determined under applicable law, for any transaction contemplated by the Shareholders Agreement and/ or these Articles, the Investor, shall except as provided in the Shareholders Agreement and/ or these Articles, be entitled to appoint a chartered accountant or merchant bank (at the Company's expense) to determine such valuation on behalf of the Company. Notwithstanding the foregoing, for the purposes of Article 21 (*Sponsor Buy-out Right/ Investor Put Option*) and Article 26 (*Event of Default*), 27 (*Completion of Transfer of the Default Sale Shares and Payment of the Default Sale Price*) and 28 (*Costs*) any such determination of valuation under applicable law shall be (i) undertaken on behalf of the Company and the Sponsors (at the Company's expense) by a chartered accountant or merchant bank appointed at the Investor's sole discretion; and (ii) binding on the Sponsors and the Company.

## 76. ENTRENCHMENT

Each of the provisions contained in these Articles are hereby entrenched pursuant to (i) Section 5 of the Companies Act; and (ii) passage of a unanimous shareholder resolution as required under applicable law. Notwithstanding anything to the contrary contained in the Shareholders Agreement and/ or these Articles, the provisions contained in these Articles can only be amended after receipt of a written consent of the Investor approving such amendment (and only to the extent of amendments specifically approved by the Investor under such approval).

### SCHEDULE 1 | TERMS AND CONDITIONS OF THE INVESTOR SHARES

## 1. DEFINITIONS

For the purposes of this Schedule:

“**Conversion**” has the meaning set out in Paragraph 4.2 of this Schedule, and the terms;

“**Convert**” and “**Converted**” shall be construed accordingly;

“**Conversion Date**” has the meaning set out in Paragraph 4.4(a) of this Schedule; “**Conversion Notice**” has the meaning set out in Paragraph 4.4(a) of this Schedule; “**Conversion Shares**” means the 291,083 (Two Hundred ninety one thousand and eighty three) Equity Shares to be issued by the Company upon conversion of the CCPS (which represent 24.44% of the fully diluted share capital on the Completion Date);

“**Corporate Action Event**” means any share split, bonus issue, stock dividend, recapitalization or recombination affecting the Shares and any other transaction having the effect of any of the foregoing;

“**Liquidation Preference Amount**” means the aggregate amounts payable to the Investor pursuant to Paragraph 3.1 of this Schedule;

“**Lowest Permissible Price**” means the lowest possible price at which a Share may (i) be issued to the Investor in accordance with applicable law; or (ii) be purchased by the Investor in accordance with applicable law (as the case may be); and

## 2. DIVIDEND PREFERENCE

2.1. The CCPS shall collectively be entitled to dividend, on a cumulative basis, being calculated on and from the date of issue thereof till the Conversion Date. The dividend each CCPS is entitled to will be an amount equal to the aggregate of:

(a) 0.01% (point zero one percent) of the aggregate face value of the CCPS in each Financial Year (reduced on

a pro rata basis for periods less than a full Financial Year); and

- (b) on a participating basis, for all dividends, if declared on Equity Shares of the Company, assuming conversion of the CCPS in its entirety,

Provided however that the aggregate of (A) and (B) shall not exceed the sum of the State Bank of India's prime lending rate prevailing as on October 16, 2014, plus 300 basis points.

- 2.2. Such dividend, if declared shall be paid for each Financial Year within a period of 30 (thirty) days from the date the Board approves the accounts of the Company for that Financial Year, and in priority and in preference to payment on any other securities issued by the Company.

### **3. LIQUIDATION PREFERENCE**

- 3.1. In the event there occurs a Winding Up, then, from the total proceeds from such Winding Up remaining after discharging, or making provision for discharging, the outstanding statutory liabilities of the Company and Company's debt obligations, the Investor shall receive in priority to all other holders of Shares, the higher of:

- (a) the CCPS Consideration plus any accrued but unpaid dividends, if any, on such CCPS; or
- (b) the Investor's Relevant Proportion of all the assets and funds of the Company legally available for distribution to the Shareholders upon such Winding Up.

- 3.2. Subsequent to the distribution of proceeds to the Investor in the manner set out in Paragraph 3.1, any balance proceeds realised in the Winding Up shall be distributed amongst the remaining Shareholders (other than the Investor) in accordance with their Relevant Proportion.

- 3.3. In the event the economic priorities set forth in Paragraph 3.1 cannot be given full effect for any reason whatsoever, to the extent necessary to accomplish the preferences set forth in Paragraph 2.1, each Shareholder (except the Investor) waives its respective rights and entitlements to its share in any payment pursuant to a Winding Up and to the extent such payments are made to, or received by, any Shareholder, such Shareholder shall jointly and severally hold the payments received by it in trust for the Investor.

### **4. CONVERSION**

#### **4.1. Optional Conversion**

Subject to Paragraph 4.4 (a), the CCPS may be converted into the Conversion Shares at any time on or after the earlier of the following events: (i) adoption of the audited financial statements of the Company for the Financial Year ending 31 March 2015; or (ii) upon the occurrence of an Event of Default.

#### **4.2. Conversion Entitlement**

The CCPS shall at all times be converted into such number of Equity Shares as represent the Conversion Shares.

The issuance of Equity Shares in accordance with the foregoing provision is referred to as "**Conversion**".

#### **4.3. Adjustment to Conversion Shares Based on Other Events**

To the extent permitted by applicable law if, on or prior to any Conversion Date, there is a Corporate Action Event, except as may be mutually agreed by the relevant Parties, the number of Conversion Shares shall be adjusted (if required) such that there is no dilution in the Investor's shareholding percentage in the Company on account of such Corporate Action Event.

#### **4.4. Mechanics of Conversion**

- (a) **Conversion Notice:** Following the adoption of the audited financial statements of the Company for the Financial Year ending 31 March 2015, the Investor shall, within 120 (one hundred twenty) days, issue a written notice to the Company (the "**Conversion Notice**") in accordance with Article 70 (*Notices*) of these Articles, to convert the CCPS; provided that if the Conversion Notice is not provided within such

120 (one hundred twenty) day period (“**Conversion Period**”), the CCPS shall automatically stand converted into the Conversion Shares. Upon receipt of the Conversion Notice, the Company shall (and the Sponsors shall procure that the Company shall) take all necessary actions (including obtaining all required Authorisations) to promptly issue the Conversion Shares to the Investor. The date of delivery of the Conversion Notice to the Company is referred to as the “**Conversion Date**”.

- (b) Issue of Conversion Shares: As soon as practicable after the earlier of the Conversion Date or the expiry of the Conversion Period (as applicable), and in any event within five (5) days thereafter, the Company at its expense will cause to be issued in the name of, and delivered to, the Investor, or, subject to the terms and conditions hereof, deliver to such other Persons as the Investor may designate, a certificate or certificates for the number of Conversion Shares to which the Investor shall be entitled upon such exercise (alternatively, if any Shares are in book entry (dematerialized form), the Company shall provide necessary instructions for the dematerialization and credit of the Conversion Shares to the demat account of the Investor within such time period). The Investor shall be deemed to be the holder of the Conversion Shares on the Conversion Date, notwithstanding that the register of members of the Company shall then be closed or that certificates representing such Conversion Shares shall not then be actually delivered to the Investor/ its nominee.
- (c) Stamp Taxes: The Company shall pay any and all documentary stamp or similar issue taxes payable in respect of the issue of the Conversion Shares.

#### 4.5. Reservation of Shares Issuable Upon Conversion

As and when required (or at any time at the Investor’s request), the Company shall (and the Sponsor shall procure that the Company shall) undertake to increase or make available out of its authorized but unissued Equity Shares, solely for the purpose of effecting the conversion of the CCPS, such number of Equity Shares as shall from time to time be sufficient to effect the conversion of all CCPS. If authorized but unissued Equity Shares are not sufficient to effect the conversion of all the CCPS, the Company shall (and the Sponsors shall procure that the Company shall) take such corporate actions as may be necessary to increase its authorized but unissued Equity Shares to such number of Shares as shall be sufficient for such purposes, including, without limitation, engaging in best efforts to obtain the requisite Shareholder approval of any necessary amendment to the Company’s Constitutional Documents.

### 5. **OTHER MATTERS**

#### 5.1. Waiver

Except as may be mutually agreed between the Parties, if a Shareholder (other than the Investor) is entitled under any contract, requirement of applicable law or otherwise to participate in relation to any issue of Equity Shares to the Investor upon Conversion, then such Shareholder hereby waives all such rights and, to the extent it cannot waive such rights, it agrees not to exercise them.

#### 5.2. All Required Actions

- (a) In the event that applicable law prevents the Investor from receiving all Conversion Shares to which it is entitled pursuant to Paragraph 4, the Sponsors and the Company shall (and the Sponsors shall procure that the Company shall) provide all necessary assistance, co-operation and support to the Investor to identify and implement alternative arrangements such that the Investor is able to achieve the shareholding in the Company that it would have achieved, and the economic benefits it would have received, had it received all Conversion Shares it is entitled to pursuant to Paragraph 4.
- (b) For the avoidance of doubt, it is clarified that all required actions to give effect to Paragraph 5.2(a) shall be consummated as simultaneously as practicable and the Parties will use their best efforts to place appropriate protection mechanisms in place (including but not limited to an escrow and the issue/ sale of Shares to the Investor at the lowest permissible price under applicable law (“**Lowest Permissible Price**”) and implement all required actions such that Investor is able to achieve the shareholding in the Company that it would have achieved, and the economic benefits it would have received, had it received all Conversion Shares it was entitled to pursuant to Paragraph 4.

#### 5.3. Ensuring Full Economic Effect

If for any reason any of the provisions set forth herein cannot be given effect to in full as a result of any change in applicable law (including a change in applicable law that affects the price at which the Investor may purchase or be issued Equity Shares) then each Shareholder (other than the Investor) and the Company shall use its respective best efforts to take all such actions (by corporate, director or shareholder action) as may be necessary to provide to the Investor the same economic benefits as are contemplated herein.

5.4. **Full Transferability**

The CCPS shall be transferable by the Investor in accordance with and subject to the terms and conditions of these Articles. A transfer of the CCPS may be effected by the execution of a Deed of Adherence prior to or at the time of transfer. Upon execution of the Deed of Adherence by the transferee, the Sponsors, the Company and the transferee shall have the rights and obligations vis-à-vis each other as if the transferee had been an original party to the Transaction Documents as an Investor (to the extent of CCPS held by the transferee). Such transfer shall be effective against the Company upon receipt by the Company of a Deed of Adherence duly executed by the transferee. Each holder of the CCPS shall be entitled to all the rights of the CCPS as set out in the Shareholders Agreement and/or these Articles provided the transferee is the holder of all the CCPS issued to the Investor.

5.5. **Priority**

The CCPS will rank senior to all other securities issued by the Company existing and future and pari passu as between themselves.

5.6. **Prompt Delivery of Accounts**

The Company and the Sponsors shall cause the auditor of the Company to provide the audited financial statements of the Company for the Financial Year 2015 within 90 (ninety) days from 31 March 2015.

5.7. **Other terms**

For avoidance of doubt, the terms of the CCPS shall not be limited to the aspects set out in this Schedule 1 (*Terms and Conditions of the Investor Shares*) and shall consist of such other terms as may be provided elsewhere in the Shareholders Agreement and/ or these Articles.

## SCHEDULE 2 | DEED OF ADHERENCE

THIS DEED OF ADHERENCE (“Deed”) is made on the day of,

BETWEEN:

- (1) **LANDMARK CARS PRIVATE LIMITED**, a company incorporated in India under the (Indian) Companies Act, 1956, whose registered office is at 3rd Floor, Landmark House, Opp. AEC, Near Gurudwara, Thaltej Cross Road, S.G. Highway, Ahmedabad, Gujarat – 380059 (the “**Company**”);

AND

- (2) [•] <To specify the name and address of the new shareholder(s) of the Company> (hereinafter referred to as “**the New Shareholder(s)**”).

**WHEREAS:**

- (A) On [•] 2014, the Company and its Shareholders entered into a Shareholders Agreement (as may be amended from time to time pursuant to its terms, the “**Shareholders' Agreement**”) to which a form of this Deed is attached as Schedule 2.
- (B) The New Shareholder wishes to have transferred to him/her/it <insert number of shares> shares (the “**Shares**”) in the capital of the Company from <insert name of Shareholder> (“**Selling Shareholder**”) and in accordance with the Shareholders' Agreement has agreed to enter into this Deed.
- (C) The Company enters this Deed on behalf of itself and as agent for all the existing Shareholders of the Company.

**NOW THIS DEED WITNESSES** as follows:

1. **Definitions**

Unless the subject or context otherwise requires, this Deed shall be interpreted in accordance with Clause 1.1 of the Shareholders Agreement.

2. **Interpretation**

In this Deed, except as the context may otherwise require, all words and expressions defined in the Shareholders' Agreement shall have the same meanings when used herein.

3. **Covenant**

3.1 The New Shareholder hereby acknowledges that it has received a copy of, and has read and understands the Shareholders' Agreement as if it was an original Party thereto, including with respect to the rights and obligations of the Parties contained therein.

3.2 The New Shareholder hereby covenants to the Company as trustee for all other Persons who are at present or who may hereafter become bound by the Shareholders' Agreement, and to the Company itself to adhere to and be bound by all the duties, burdens and obligations of a Shareholder holding the same class of shares as the Shares imposed pursuant to the provisions of the Shareholders' Agreement and all documents expressed in writing to be supplemental or ancillary thereto as a Shareholder.

3.3 The New Shareholder hereby further confirms that at any time it intends to Transfer its Shares in accordance with the Shareholders Agreement, it shall notify each of the Parties of such fact.

4. **Representations and Warranties**

The New Shareholder represents and warrants to each of the Company as follows:

4.1 Status

It is a company duly established and existing under the laws of <insert> and has the power and authority to own its assets and to conduct the business which it conducts and/or proposes to conduct.

4.2 Powers

It has the power (a) to enter into, exercise its rights and perform and comply with its obligations under this Deed and (b) to act as a Shareholder of the Company.

4.3 Authorisation and Consents

All actions, conditions and things required to be taken, fulfilled and done (including the obtaining of necessary consents) in order (a) to enable it lawfully to enter into, exercise its rights and perform and comply with its obligations under this Deed and the Shareholders Agreement are valid, legally binding and enforceable and (b) to make this Deed and the Shareholders Agreement admissible in evidence in the courts of the jurisdiction in which it is incorporated, have been taken, fulfilled and done.

4.4 Non-Violation of Laws

Its entry into, exercise of its respective rights and/or performance of or compliance with their respective obligations under this Deed and the Shareholders Agreement and the purchase of the Shares do not and will not violate or exceed any restriction imposed by (a) any laws and regulations binding on it to which it is subject or (b) its Memorandum or Articles, as the case may be.

4.5 Obligations Binding

Its obligations under this Deed and the Shareholders Agreement are valid, binding and enforceable.

4.6 Non-Violation of Other Agreements

Its entry into, exercise of its rights and/or performance of or compliance with its respective obligations under this Deed and the Shareholders Agreement and the purchase of the Shares do not and will not violate any agreement to which it is a party.

4.7 No Litigation

There are no legal, quasi-legal, administrative, arbitration, mediation, conciliation or other proceedings, claims, actions, governmental investigations, orders, judgments or decrees of any nature made, existing, threatened, anticipated or pending against it which may prejudicially affect its holding of the Shares or the due performance or enforceability of the Shareholders Agreement or this Deed or any obligation, act, omission or transaction contemplated thereunder or hereunder.

5. **Assumption of Obligations**

The New Shareholder undertakes to the Company that it will, with effect from the time of completion of the Transfer of the Shares to it assume, perform and comply with each of the obligations of the Transferor under the Shareholders Agreement as if it had been a party to the Shareholders Agreement at the date of execution thereof and both the Transferor and the New Shareholder shall be considered as a single block of Shareholder.

6. **Transfer of Rights**

[The following rights listed below and attached to the Shares under the Shareholders Agreement, have been assigned and transferred to the New Shareholder] *<to be inserted only (i) if the Selling Shareholder is the Investor; and (ii) (a) the New Shareholder is not an Affiliate of the Investor and (b) there is a part transfer of Shares then held by the Investor>*:

*<please insert>*

[All the rights attached to the Shares under the Shareholders Agreement, have been assigned and transferred to the New Shareholder] *<to be inserted only (i) if the Selling Shareholder is the Investor; and (ii) (a) the New Shareholder is an Affiliate of the Investor or (b) the New Shareholders is not an Affiliate and there is a full transfer of Shares then held by the Investor>*

7. **Notices**

7.1 The address and facsimile number designated by the New Shareholder for the purposes of

Article 70 (*Notices*) of the Shareholders Agreement are:

Address: *<please insert>*

Fax: *<please insert>*

For the attention of: *<please insert>*

8. **General Provision**

The provisions of Articles 60 (*Governing Law*) and 61 (*Dispute Resolution*) of the Shareholders Agreement are incorporated into this Deed as if set out in full in this Deed and as if references in those clauses to “this Agreement” are references to this Deed.

**IN WITNESS WHEREOF** this Deed of Adherence has been executed as a deed on the date first above written.

## LANDMARK CARS PRIVATE LIMITED

By:

Name:

Title:

*[NAME OF NEW SHAREHOLDER]*

By:

Name:

Title:

### SCHEDULE 3 | COMPANY COVENANTS

#### 1. Each Group Company shall:

- 1.1. Keep properly all statutory books and registers including the register of members of the Group Companies.
- 1.2. Correctly make up, duly file and/or deliver all returns and particulars, resolutions and other documents that any Group Company is required by law to file with or deliver to any Governmental Authority.
- 1.3. Keep full minutes of meetings of the Board and meetings of any committee of the Board including details of the Directors in attendance, the matters discussed, and the resolutions tabled.
- 1.4. Not undertake any action or omit to do any action that would result in jeopardising the Investor's ability to invest in the Company pursuant to any law including the provisions of the Foreign Direct Investment Policy of the Government of India, the Foreign Exchange Management Act, 1999 and any rules and regulations or circulars issued thereunder.

#### 1A.<sup>11</sup> Termination of Key Employees

Prior to terminating the services of Mr. Sanjay Thakker, Mr. Parasbhai Somani, Ms. Urvi Mody, the Group Company will consult with the Investor and give reasonable prior notice to the Investor of its intention to terminate the services of the aforesaid persons.

#### 2. Taxes

- 2.1. Exercise all rights and powers available to it to procure that all Taxation of any nature whatsoever for which any Group Company is liable, and which has fallen due for payment is duly paid or properly contested before the appropriate Governmental Authorities.
- 2.2. Exercise all rights and powers available to it to procure that all notices, computations and returns are properly and duly submitted by each Group Company to the relevant Taxation authorities and all information, notices, computations and returns submitted to such authorities are true, accurate and complete and that all records which any Group Company is required to keep for Taxation purposes or which would be needed to substantiate any claim made or position taken in relation to Taxation by the relevant Group Company are duly kept and are available for inspection upon reasonable notice at the premises of the relevant Group Company.

#### 3. Taxes

- 3.1. Exercise all rights and powers available to it to procure that all Taxation of any nature whatsoever for which any Group Company is liable, and which has fallen due for payment is duly paid or properly contested before the

---

<sup>11</sup> Para 2 of Schedule 3 has been amended by Members of the Company by passing a special resolution at 12th Annual General Meeting held on 26th September, 2018

appropriate Governmental Authorities.

- 3.2. Exercise all rights and powers available to it to procure that all notices, computations and returns are properly and duly submitted by each Group Company to the relevant Taxation authorities and all information, notices, computations and returns submitted to such authorities are true, accurate and complete and that all records which any Group Company is required to keep for Taxation purposes or which would be needed to substantiate any claim made or position taken in relation to Taxation by the relevant Group Company are duly kept and are available for inspection upon reasonable notice at the premises of the relevant Group Company.

#### **4. Accounts and Financials**

- 4.1. Exercise all rights and powers available to it to procure that its accounts are prepared in accordance with the generally accepted accounting principles in India and that all relevant documents in connection therewith are maintained.
- 4.2. Exercise all rights and powers available to it to procure that its accounts correctly state its assets and liabilities and give a true and fair view of its state of affairs and of its profit and loss.
- 4.3. Exercise all rights and powers available to it to procure that its accounts contain either provision adequate to cover, or provide full particulars in notes of, all Taxation (including deferred taxation) and other liabilities whether quantified, contingent or otherwise of the Group Company.

#### **5. Auditor**

Appoint or procure appointment of one of the Big 4 Accounting Firms as the statutory auditor of the Group Companies and Landmark Pre-Owned Cars Private Limited for Financial Year 2014 – 2015 and thereafter appoint or procure appointment of one of the Big 4 Accounting Firms as either the statutory auditor or internal auditor of the Group Companies and Landmark Pre-Owned Cars Private Limited.

#### **6. Appointment of A Compliance Officer**

Employ a suitably qualified company secretary or other person qualified under applicable law to act as a compliance officer and assist with each Group Company's compliance with applicable law, including but not limited to: (i) maintaining accurate and up to date statutory records; (ii) ensuring that each Group Company is in material compliance with applicable employment regulations in India; and (iii) ensuring that the establishments from which each Group Company conducts its business is in material compliance with licensing, safety and other applicable work place requirements in India.

#### **7. Insurance**

- 7.1. Maintain insurance policies in a sufficient amount and with such coverage as are (i) generally maintained by companies in the same industry; and (ii) where applicable, each Group Company shall maintain insurance which is in accordance with any insurance coverage requirements set out in a contract to which it is a party (or by which it is bound). Notwithstanding the generality of the foregoing, such policies shall be sufficient to cover liabilities in relation to product liabilities, environmental liabilities, fire or acts of God that the facilities of the Group Company could be subject to and such other liabilities which the Group Companies may in the reasonable opinion of the Investor be considered at risk in the course of their respective businesses.
- 7.2. Procure suitable directors' and officers' insurance for all the Directors and senior officers of the Company, which insurance shall be in a sufficient amount and with such coverage as is mutually agreed between Sponsor 1 and the Investor.

#### **8. Related Party Transactions**

- 8.1. Without prejudice to the provisions of Article 41.2.17 (*Affirmative Rights of the Investor*), ensure that:
  - (a) Any and all agreements, contracts or similar arrangements between a Group Company and Related Parties (each, a "**Related Party Transaction**") shall (i) be on an arms' length basis, (ii) not be unlawful or illegal, and (iii) be as per the prevalent market standards and practices for industries engaged in a business similar or identical to the Business. All material information relating to any such Related Party



Transactions proposed to be undertaken by a Group Company shall be disclosed by the Company to the Board, within 15 (fifteen) days of their being proposed and before any final decision is taken in relation to the transaction.

- (b) The Investor, with respect to any Related Party Transaction, shall have the sole and exclusive right to cause the Company to approve, amend and/or modify any such Related Party Transaction if such Related Party Transaction is (i) not on an arm's length basis; (ii) unlawful or illegal, or (iii) is not as per the prevalent market standards and practices for industries engaged in a business similar or identical to the Business. Furthermore, the Investor, with respect to any Related Party Transaction, shall have the sole and exclusive right to cause a Group Company to enforce any such Related Party Transaction (including the exercise of any rights in accordance with the terms of the agreement) thereunder with sufficient cause.
- (c) Any right of action which a Group Company may have in respect of breach of any Related Party Transaction may be prosecuted by the Investor Director (with respect to any Related Party Transaction), provided such Investor Director acts in good faith.

The Investor Director shall have full authority on behalf of a Group Company to negotiate, litigate and settle any claim arising out of the breach or exercise any right of termination arising out of the breach of such Related Party Transaction, and the Sponsors and the Group Companies shall take all steps within their power to give effect to this provision.

- 8.2. The Investor shall after consultation with Sponsor 1 have the right to unilaterally terminate, without cost or liability to a Group Company or the Investor, any Related Party Transactions upon a material breach or default by the relevant Related Party. In case of such termination, the due process of termination under the Related Party Transactions (if any, and to the extent such process has been approved by the Investor) shall be complied with.

#### **SCHEDULE 4 | REGULATORY REQUIREMENTS**

##### **1. Sponsors Funding**

Each of the Sponsors represents, warrants and covenants to the Investor that:

- 1.1 The Sponsors shall take for so long as Shares are issued to the Investor, such measures as are required by law to assure that the funds invested in the Company or any of the Group Companies are derived from transactions that do not violate the Anti-Money Laundering Laws, Sanctions Laws and Regulations, and the Anti-Corruption Laws.
- 1.2 The Sponsors have not received any notice from any Governmental Authority indicating they are (i) under investigation by any Governmental Authority for, or has been charged with, or convicted of, money laundering, drug trafficking, terrorist related activities, anti-corruption related activities or any Anti-Money Laundering Laws and Sanctions Laws and Regulations; or (ii) has had any of its funds seized or forfeited in any action under any Anti-Money Laundering Laws and Sanctions Laws and Regulations.
- 1.3 The Sponsors agree to cooperate with the Investor, and to cause each of the Group Companies to cooperate, in providing, upon reasonable notice, such additional information and documentation on the Sponsors and the Group Companies' legal or beneficial ownership, policies, procedures and sources of funds as the Investor deems necessary or prudent to enable the Investor, the Company and/or its Subsidiaries to comply with Anti-Money Laundering Laws and Sanctions Laws and Regulations as now in existence or hereafter amended.
- 1.4 The Company shall, and shall cause its Subsidiaries and the officers, directors, employees and agents of the Company and its Subsidiaries to conduct the business of the Company and/or the Subsidiaries in compliance with all applicable laws (including any reporting obligations) to which any such person is subject, and not to offer, promise, give, or authorize or approve the giving of, anything of value, directly or through a third party, to any Government Official in order to influence official action or otherwise obtain an improper business advantage relating to the business of the Company and/or its Subsidiaries.
- 1.5 Subject to remedial action undertaken by the Sponsors under paragraph 1.6 below, the Sponsors acknowledge that if the Investor believes that the Sponsors or any Group Company may have breached any of the

representations, warranties or covenants set forth in this Schedule, the Investor shall have the right (and may have the obligation under applicable law), with notice to the Sponsors and consultation with the Sponsors, to notify the appropriate Governmental Authority and to take such action as such Governmental Authority may direct.

- 1.6 The Sponsors acknowledge that if the Investor believes that the Sponsors or any Group Company is taking actions that violate or cause the Investor, the Company or any Group Company to violate any applicable Anti-Money Laundering Laws and Sanctions Laws and Regulations, upon notice from the Investor, the Sponsors shall immediately desist from taking such actions and take steps to remedy the effects of any such actions.
- 1.7 Neither the Sponsors nor any Group Company is a person with whom transactions are currently prohibited under any Anti-Money Laundering Laws and Sanctions Laws and Regulations. The Sponsors agree not to use, directly or indirectly, the proceeds received from the CCPS for the purpose of funding or facilitating any activities or business of or with any Person that is, at the time of such funding or facilitation, a Sanctions Target, or in any other manner that would result in a violation of any provision of any of the Anti-Money Laundering Laws and Sanctions Laws and Regulations by any Person. The Company and its Subsidiaries will maintain all necessary and appropriate safeguards to ensure their compliance with this covenant and the Investor shall provide all reasonable assistance specifically requested by the Sponsors / Group Companies to ensure compliance with this covenant.

## 2. **Background Checks**

The Group Companies shall cause to be delivered to the Investor all information requested by the Investor to satisfy its reporting and audit obligations to the Investor's direct and indirect investors. The Group Companies shall, if so directed by the Investor, perform background checks on third parties transacting business of a material nature with the Group Companies and shall not knowingly allow the Group Companies to transact business with any Third Party who, because of such Third Party's known bad character, criminal conduct or criminal associations or status on any "restricted" or "prohibited" list, could cause any Group Companies, the Investor or any of the Investor's Affiliates regulatory issues with respect to and/or under the Anti-Money Laundering Laws, Sanctions Laws and Regulations, Anti-Corruption Laws, gaming, liquor, anti-terrorism or other such regulations.

## 3. **Prohibited Actions**

### *ANTI-CORRUPTION*

- 3.1 Neither the Company nor the Group Companies nor any of their Subsidiaries, agents and employees, shall take any act that would cause the Company, the Group Companies, their Subsidiaries or, as of the date of the hereof, the Investor to be in violation of the United States Foreign Corrupt Practices Act of 1977, as amended, the United Kingdom Bribery Act 2010, as amended, the India Prevention of Corruption Act, 1988, as amended, or any other anti-corruption or anti-bribery laws or regulations applicable to the Company, the Group Companies or their Subsidiaries (collectively, the "**Anti-Corruption Laws**").
- 3.2 Without limiting the generality of the foregoing, neither the Company nor any of its Subsidiaries, officers, directors, employees, shall take any act in furtherance of a payment, offer, promise to pay, or authorization or ratification of a payment of any gift, money or anything of value to:
  - (a) a Government Official; or
  - (b) any person or entity while knowing or having reasonable grounds to believe that all or a portion of that payment will be passed on to a Government Official to obtain or retain business or to secure an improper advantage.
- 3.3 No Government Official or Government Entity shall receive an interest, whether direct or indirect, legal or beneficial, in the Company or in any of its Subsidiaries or receive any legal or beneficial interest in payments made to the Sponsors, the Company or the Group Companies pursuant to these Articles.
- 3.4 The Company and each of its Subsidiaries shall maintain reasonable internal controls and procedures intended to ensure compliance with the Anti-Corruption Laws, including an anti-corruption compliance policy.

- 3.5 The Company and each of its Subsidiaries shall:
- (a) maintain its Books and Records in a manner that, in reasonable detail, accurately and fairly reflects the transactions and disposition of their assets, and
  - (b) maintain a system of internal accounting controls sufficient to provide reasonable assurances that: (A) the transactions are executed and access to assets is given only in accordance with management's authorization; (B) the transactions are recorded as necessary to permit preparation of periodic financial statements and to maintain accountability of corporate assets; and (C) the transactions are recorded as necessary to permit preparation of periodic financial statements and to maintain accountability of corporate assets.
- 3.6 No director or officer of the Company, the Group Companies or any of their Subsidiaries shall make or cause to be made false or misleading statements to, or shall attempt to coerce or fraudulently influence, an accountant in connection with any audit, review or examination of the financial statements of the Company or any of its Subsidiaries.
- 3.7 Notwithstanding any other provision of these Articles to the contrary, nothing herein shall (i) require any Shareholder to make any payment that it reasonably believes will constitute a violation of the Anti-Corruption Laws or (ii) prohibit any Shareholder, in its sole discretion, from reporting any actual or possible violation of the Anti-Corruption Laws to law enforcement officials after discussion and consultation with Sponsor 1.
- 3.8 The Sponsors shall ensure that the Group Companies and their respective officers, employees and agents shall not cause a violation of the Anti-Corruption Laws to occur.

#### 4. **Transactional Requirements**

- 4.1 The Parties acknowledge that Investor and its Affiliates may be subject to (i) the FCPA, (ii) the Anti-Corruption Laws; (ii) Title III of the Uniting and Strengthening America by Providing Appropriate Tools Required to Intercept and Obstruct Terrorism Act of 2001, Pub. L. No. 107-56 (2001) (“**USA Patriot Act**”) and other similar laws and regulations, (iii) U.S. economic and trade sanctions laws, regulations, and executive orders, including but not limited to those administered by OFAC, and (iv) U.S. anti-boycott laws and regulations administered by the U.S. Department of Commerce and the U.S. Internal Revenue Service (collectively, the “**Transactional Requirements**”). For convenience, as of date, details of the Transactional Requirement may be located at:

FCPA: <http://www.justice.gov/criminal/fraud/fcpa/docs/fcpa-english.pdf>

UK Bribery Act: <http://www.legislation.gov.uk/ukpga/2010/23/contents>

USA Patriot Act: available at <http://www.gpo.gov/fdsys/pkg/PLAW-107publ56/pdf/PLAW-107publ56.pdf>

OFAC and similar sanctions laws:

<https://www.treasury.gov/ofac/downloads/t11sdn.pdf> <http://www.hm-treasury.gov.uk/d/sanctionsconlist.pdf>.

[http://ec.europa.eu/external\\_relations/cfsp/sanctions/consol-list\\_en.htm](http://ec.europa.eu/external_relations/cfsp/sanctions/consol-list_en.htm) <http://www.un.org/sc/committees/>

<http://www.treasury.gov/resource-center/sanctions/Programs/Pages/Programs.aspx>

Anti-boycott laws:

[http://www.bis.doc.gov/index.php/forms-documents/doc\\_view/428-part-760-restrictive-trade-practices-or-boycotts](http://www.bis.doc.gov/index.php/forms-documents/doc_view/428-part-760-restrictive-trade-practices-or-boycotts)

<http://www.gpo.gov/fdsys/pkg/USCODE-2009-title26/content-detail.html>

<http://www.gpo.gov/fdsys/pkg/USCODE-2010-title26/pdf/USCODE-2010-title26-subtitleA-chap1-subchapN-partV.pdf>

<http://www.irs.gov/pub/irs-pdf/i5713.pdf>

[http://www.irs.gov/irm/part4/irm\\_04-061-006.html](http://www.irs.gov/irm/part4/irm_04-061-006.html)

- 4.2 The Sponsors covenant that the Sponsors and the Group Companies shall not and shall notify / direct their respective direct or indirect shareholders, officers, directors, employees and agents not to take any action or knowingly omit to take any action that would cause a violation by any Group Company or the Investor or any of its respective Affiliates of the Transactional Requirements, regardless of U.S. jurisdiction over the activity.

4.3 The Company shall and shall use best efforts to cause its Subsidiaries to, adopt no later than 3 (three) months following the Completion Date the compliance code attached as Exhibit A (*Compliance Code*) to the Shareholders Agreement or a comparable compliance program and code of conduct mutually agreed between the Investor and the Sponsor 1 (the “**Compliance Code**”). In implementing the Compliance Code, the Company shall, and shall cause each Subsidiary and the directors, officers, employees of the Company and the Subsidiaries to follow the policies and procedures set forth in the Compliance Code including (i) all training, education and certification procedures, (ii) all due diligence procedures related to agents of the Company and the Subsidiaries, (iii) all audit and internal control procedures, (iv) adequate commitment of resources to ensure the capacity to carry out the programs required by the Compliance Code and (v) appropriate procedures to ensure accurate Books and Records, and other policies and procedures set forth in the Compliance Code. The Company shall cause a chief compliance officer to be appointed by the Company (who shall be a suitable and competent person with relevant knowledge of and experience with laws applicable to the Company to carry out the compliance function of the Company). The Company shall cause disciplinary procedures to be enforced and mechanisms for reporting suspected violations to be created.

## SECTION X - OTHER INFORMATION

### MATERIAL CONTRACTS AND DOCUMENTS FOR INSPECTION

The copies of the following documents and contracts which have been entered or are to be entered into by our Company (not being contracts entered into in the ordinary course of business carried on by our Company), which are or may be deemed material will be attached to the copy of the Red Herring Prospectus and the Prospectus, as applicable, which will be filed with the RoC. Copies of the documents for inspection referred to hereunder, may be inspected at the Registered Office between 10 a.m. and 5 p.m. on Working Days and on the website of our Company at <https://www.grouplandmark.in/corporate-document/> from the date of the Red Herring Prospectus until the Bid/Offer Closing Date.

Any of the contracts or documents mentioned in this Draft Red Herring Prospectus may be amended or modified at any time if so, required in the interest of our Company or if required by the other parties, without reference to the Shareholders, subject to compliance of the provisions contained in the Companies Act and other applicable law.

#### A. Material Contracts for the Offer

1. Registrar Agreement dated January 17, 2022, entered into between our Company, the Selling Shareholders and the Registrar to the Offer.
2. Offer Agreement dated January 17, 2022, entered into between our Company, the Selling Shareholders and the BRLMs.
3. Cash Escrow and Sponsor Bank Agreement dated [●] entered into between our Company, the Selling Shareholders, the Registrar to the Offer, the BRLMs and the Banker(s) to the Offer.
4. Share Escrow Agreement dated [●] entered into between the Selling Shareholders, our Company and the Share Escrow Agent.
5. Syndicate Agreement dated [●] entered into between our Company, the Selling Shareholders, the BRLMs, Registrar to the Offer and the Syndicate Members.
6. Monitoring Agency Agreement dated [●] entered into between our Company and the Monitoring Agency.
7. Underwriting Agreement dated [●] entered into between our Company, the Selling Shareholders, and the Underwriters and the Registrar to the Offer.

#### B. Material Documents

1. Certified copies of the Memorandum of Association and Articles of Association, as amended from time to time.
2. Certificate of incorporation dated February 23, 2006, issued by the RoC, Mumbai.
3. Fresh certificate of incorporation was issued by the RoC, Mumbai on May 6, 2006, pursuant to change in the name of our Company from '*Landmark Insurance Broking Private Limited*' to '*Landmark Cars Private Limited*'.
4. Fresh certificate of incorporation dated December 3, 2021, issued by the RoC, consequent to the change of name from '*Landmark Cars Private Limited*' to '*Landmark Cars Limited*', pursuant to conversion into a public limited company.
5. Shares Subscription and Shareholders Agreement dated February 14, 2013, entered into between Sanjay Karsandas Thakker, Ami Sanjay Thakker, Landmark Cars (East) Private Limited, Autocity Services Private Limited, and our Company.
6. Shareholders Agreement dated November 4, 2014 and the amendment agreements dated January 29, 2016 and September 30, 2018, entered into between TPG Growth, Sanjay Karsandas Thakker, Ami Sanjay Thakker and our Company.

7. Waiver cum Amendment Agreement to the Shareholders Agreement dated January 11 2022, entered into between TPG Growth, Sanjay Karsandas Thakker, Ami Sanjay Thakker and our Company.
8. Composite scheme of arrangement and amalgamation in the nature of demerger and amalgamation between our Company, Automark Motors Private Limited and Watermark Vehicles Private Limited and their respective shareholders and creditors, approved and sanctioned by the National Company Law Tribunal, Ahmedabad by way of its order dated April 4, 2019.
9. Composite scheme of arrangement and amalgamation in the nature of demerger and amalgamation between our Company, Landmark Automobiles Private Limited and Watermark Automobiles Private Limited and their respective shareholders and creditors, approved and sanctioned by the National Company Law Tribunal, Ahmedabad by way of its order dated April 4, 2019.
10. Composite scheme of arrangement and amalgamation in the nature of demerger and amalgamation between our Company, Landmark Commercial Vehicles Private Limited and Watermark Commercial Vehicles Private Limited and their respective shareholders and creditors, approved and sanctioned by the National Company Law Tribunal, Ahmedabad by way of its order dated April 4, 2019.
11. Resolution of the Board of Directors dated January 11, 2022 authorising the Offer and other related matters.
12. Resolution dated January 11, 2022 passed by the Shareholders authorising the Fresh Issue and other related matters.
13. Consent letter dated January 11, 2022 from Sanjay Karsandas Thakker HUF in relation to the Offer for Sale.
14. Consent letter dated January 11, 2022 from Garima Misra in relation to the Offer for Sale.
15. Consent letter dated January 18, 2022 and resolution passed by the board of directors of TPG Growth on December 15, 2021, for participation in the Offer for Sale.
16. Consent letter dated January 11, 2022 and authorisation letter issued by Aastha Limited on January 11, 2022 for participation in the Offer for Sale.
17. Resolution of the Board of Directors dated January 17, 2022 approving this Draft Red Herring Prospectus.
18. Resolution of the IPO Committee dated January 18, 2022 approving this Draft Red Herring Prospectus.
19. Consent dated December 24, 2021, from CRISIL to rely on and reproduce part or whole of the CRISIL Report and include their name in this Draft Red Herring Prospectus.
20. Written consent dated January 18, 2022 from the Statutory Auditors, Deloitte Haskins & Sells, Chartered Accountants, to include their name as an “expert” in their capacity as our Statutory Auditors, and in respect of their (i) examination report dated January 17, 2022 on our Restated Consolidated Financial Information; and (ii) their report dated January 18, 2022 on the statement of special tax benefits in this Draft Red Herring Prospectus.
21. The examination report dated January 17, 2022 of the Statutory Auditors on our Restated Consolidated Financial Information.
22. The report on the statement of possible special tax benefits dated January 18, 2022, from the Statutory Auditors.
23. Report titled “*CRISIL Research - Industry Assessment of Automobile Dealership Industry in India released in Mumbai in December 2021*” prepared by CRISIL.
24. Copies of annual reports of our Company for the Fiscals 2021, 2020 and 2019.
25. Consents of the Directors, BRLMs, Syndicate Members, the legal counsel to the Company as to Indian law, the legal counsel to the Book Running Lead Managers as to Indian law, the legal counsel to the Book Running Lead Managers as to international law, legal counsel to the Selling Shareholders as to Indian law, Advisor to the Company (for fund-raising including the Offer), Registrar to the Offer, Banker(s) to the Offer, Bankers to our

Company, Company Secretary and Compliance Officer and the independent chartered accountant, as referred to in their specific capacities.

26. Tripartite agreement dated December 31, 2021, among our Company, NSDL and the Registrar to the Offer.
27. Tripartite agreement dated December 16, 2021, among our Company, CDSL and the Registrar to the Offer.
28. Due diligence certificate dated January 18, 2022, addressed to SEBI from the BRLMs.
29. In-principle listing approvals dated [●] and [●] issued by BSE and NSE, respectively.
30. SEBI observation letter bearing reference number [●] and dated [●].

Any of the contracts or documents mentioned in this Draft Red Herring Prospectus may be amended or modified at any time if so required in the interest of our Company or if required by the other parties, without reference to the shareholders, subject to compliance with the provisions contained in the Companies Act and other relevant statutes.

## DECLARATION

We hereby certify and declare that all relevant provisions of the Companies Act and the rules, regulations and guidelines issued by the Government of India or the rules, regulations and guidelines issued by the SEBI, established under Section 3 of the SEBI Act, as the case may be, have been complied with and no statement made in this Draft Red Herring Prospectus is contrary to the provisions of the Companies Act 2013, the SCRA, the SCRR, the SEBI Act or the rules, regulations or guidelines issued thereunder, as the case may be. We further certify that all statements made in this Draft Red Herring Prospectus are true and correct.

## SIGNED BY THE DIRECTORS OF OUR COMPANY

**Sanjay Karsandas Thakker**  
*(Chairman and Executive Director)*

**Paras Somani**  
*(Executive Whole-Time Director)*

**Aryaman Sanjay Thakker**  
*(Executive Director)*

**Akshay Tanna**  
*(Nominee Director of TPG Growth)*

**Gautam Yogendra Trivedi**  
*(Independent Director)*

**Sucheta Nilesh Shah**  
*(Independent Director)*

**Manish Balkishan Chokhani**  
*Independent Director*

**Ramakant Sharma**  
*Independent Director*

## SIGNED BY THE CHIEF FINANCIAL OFFICER OF OUR COMPANY

Surendra Kumar Agarwal  
*(Chief Financial Officer)*

**Date:** JANUARY 18, 2022

**Place:** MUMBAI



## DECLARATION

We, TPG Growth II SF Pte. Ltd., acting as a Selling Shareholder, hereby certify and declare that all statements, disclosures, and undertakings made or confirmed by us in this Draft Red Herring Prospectus in relation to ourselves and the Equity Shares being offered by us in the Offer are true and correct. We assume no responsibility, as a Selling Shareholder, for any other statements, including, any of the statements made or confirmed by or relating to the Company or any other person(s) in this Draft Red Herring Prospectus.

**Signed for and on behalf of TPG Growth II SF Pte Ltd.**

---

*Authorised Signatory:* **Nadia M. Karkar**

*Designation:* **Director**

**Place:** San Francisco, CA

**Date:** January 18, 2022

## DECLARATION

We, Sanjay Karsandas Thakker HUF, acting as a Selling Shareholder, hereby certify and declare that all statements, disclosures, and undertakings made or confirmed by us in this Draft Red Herring Prospectus in relation to ourselves and the Equity Shares being offered by us in the Offer are true and correct. We assume no responsibility, as a Selling Shareholder, for any other statements, including, any of the statements made or confirmed by or relating to the Company or any other person(s) in this Draft Red Herring Prospectus.

**Signed for and on behalf of Sanjay Karsandas Thakker HUF**

---

*Authorised Signatory: SANJAY KARSANDAS THAKKER*

*Designation: KARTA*

**Place:** MUMBAI

**Date:** JANUARY 18, 2022

## **DECLARATION**

We, Aastha Limited, acting as a Selling Shareholder, hereby certify and declare that all statements, disclosures, and undertakings made or confirmed by us in this Draft Red Herring Prospectus in relation to ourselves and the Equity Shares being offered by us in the Offer are true and correct. We assume no responsibility, as a Selling Shareholder, for any other statements, including, any of the statements made or confirmed by or relating to the Company or any other person(s) in this Draft Red Herring Prospectus.

**Signed for and on behalf of Aastha Limited**

*Authorised Signatory:* CHETAN PRAVINCHAND JHAVERI  
*Designation:* DIRECTOR

**Place:** MUMBAI

**Date:** JANUARY 18, 2022

## **DECLARATION**

I, Garima Misra, acting as a Selling Shareholder, hereby certify and declare that all statements, disclosures, and undertakings made or confirmed by me in this Draft Red Herring Prospectus in relation to myself and the Equity Shares being offered by me in the Offer are true and correct. I assume no responsibility, as a Selling Shareholder, for any other statements, including, any of the statements made or confirmed by or relating to the Company or any other person(s) in this Draft Red Herring Prospectus.

**Signed by**

**Garima Misra**

**Place:** MUMBAI

**Date:** JANUARY 18, 2022